

TE1120

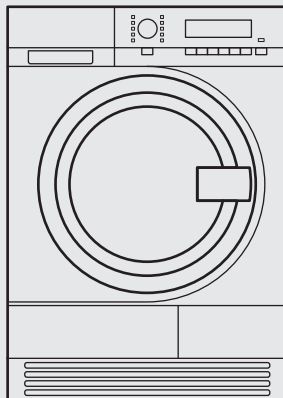

EN User Manual

Tumble Dryer



Electrolux

CAUTION: Read the instructions before using the appliance. Original Instructions.

CONTENTS

1. SAFETY INFORMATION.....	2
2. PRODUCT DESCRIPTION.....	8
3. ACCESSORIES.....	9
4. CONTROL PANEL.....	10
5. COIN OPERATED MACHINES.....	11
6. PROGRAMME TABLE.....	11
7. OPTIONS.....	12
8. BEFORE FIRST USE.....	13
9. DAILY USE.....	13
10. HINTS AND TIPS.....	15
11. CARE AND CLEANING.....	15
12. TROUBLESHOOTING.....	18
13. TECHNICAL DATA.....	20

WE'RE THINKING OF YOU

Thank you for purchasing an Electrolux appliance. You've chosen a product that brings with it decades of professional experience and innovation. Ingenious and stylish, it has been designed with you in mind. So whenever you use it, you can be safe in the knowledge that you'll get great results every time.

Welcome to Electrolux.

CUSTOMER CARE AND SERVICE

Always use original spare parts.

When contacting our Authorised Service Centre, ensure that you have the following data available: Model, PNC, Serial Number.

The information can be found on the rating plate.

 Read the instructions before using the appliance

 Warning / Caution-Safety information

 General information and tips

 Environmental information

Subject to change without notice.

1. SAFETY INFORMATION

Before the installation and use of the appliance, carefully read the supplied instructions. The manufacturer is not responsible if an incorrect installation and use causes injuries and damages. Always keep the instructions with the appliance for future reference.

1.1 Children and vulnerable people safety

**WARNING!**

Risk of suffocation, injury or permanent disability.

- This appliance can be used by children aged from 8 years and above and persons with reduced physical, sensory or mental capabilities or lack of experience and knowledge if they have been given supervision or instruction concerning use of the appliance in a safe way and understand the hazards involved.
- Do not let children play with the appliance.
- Children of less than 3 years should be kept away unless continuously supervised.
- Keep all packaging away from children.
- Keep all detergents away from children.
- Keep children and pets away from the appliance door when it is open.
- If the appliance has a child safety device, we recommend you activate it.
- Cleaning and user maintenance shall not be made by children without supervision.

1.2 Installation

- Follow the installation instruction supplied with the appliance.
- Make sure that the appliance is stable during transportation.
- Remove all the packaging.
- Do not install or use a damaged appliance.
- Always be careful when you move the appliance because it is heavy. Always wear safety gloves.
- Always move the appliance vertically.
- The appliance can be installed as freestanding or below the kitchen counter with correct space (Refer to the Installation leaflet).
- If the tumble dryer is put on top of a washing machine, use the stacking kit. The stacking kit, available from your authorized vendor, can be used only with the

appliance specified in the instructions, supplied with the accessory. Read it carefully before installation (Refer to the Installation leaflet).

- Do not install or use the appliance where the temperature is less than 5°C or higher than 35°C.
- Do not install the appliance behind a lockable door, a sliding door or a door with a hinge on the opposite side, where the appliance door can not be fully opened.
- Make sure that the floor where you install the appliance is flat, stable, heat resistant and clean.
- Make sure that there is air circulation between the appliance and the floor.
- The rear surface of the appliance must be put against the wall.
- When the appliance is put in its permanent position, check if it is fully level with the aid of a spirit level. If it is not, adjust the feet until it is.
- Make sure that the appliance is disconnected from the electricity supply during installation, maintenance and repairs and cannot be reconnected until all work has been carried out.
- Connect the mains plug to the mains socket only at the end of the installation. Make sure that there is access to the mains plug after the installation.
- Ensure you have good ventilation in the installation room to avoid the back flow of gases into the room from appliances burning other fuels, including open fires.
- Exhaust air must not be discharged into a flue which is used for exhausting fumes from appliances burning gas or other fuels. (if applicable)
- The ventilation openings in the base (if applicable) must not be obstructed by a carpet.

1.3 Electrical connection



WARNING!

Risk of fire and electrical shock.

- The appliance must be correctly earthed. The manufacturer is not responsible for the consequences of an inadequate earthing system.
- Make sure that the electrical information on the rating plate agrees with the power supply. If not, contact an electrician.
- Always use a correctly installed shockproof socket.
- Do not use multi-plug adapters and extension cables.
- Do not pull the mains cable to disconnect the appliance. Always pull the mains plug.
- Do not touch the mains cable or the mains plug with wet hands.
- If the supply cord is damaged, it must be replaced by the manufacturer, its Authorised Service Centre or similarly qualified persons in order to avoid a hazard.
- Only for UK and Ireland. The appliance has a 13 amp mains plug. If it is necessary to change the fuse in the mains plug, use a 13 amp ASTA (BS 1362) fuse.
- This appliance complies with the E.E.C. Directives.

1.4 Use



WARNING!

Risk of injury, electrical shock, fire, burns or damage to the appliance.

- Obey the maximum load volume of 8kg (refer to the “Programme chart” chapter).
- Do not use the appliance if industrial chemicals have been used for cleaning.
- Wipe away lint that has accumulated around the appliance.
- Do not run the appliance without a filter. Clean the lint filter before or after each use.
- Do not dry unwashed items in the tumble dryer.
- Items that have been soiled with substances such as cooking oil, acetone, alcohol, petrol, kerosene, spot removers, turpentine, waxes and wax removers should

be washed in hot water with an extra amount of detergent before being dried in the tumble dryer.

- Items such as foam rubber (latex foam), shower caps, waterproof textiles, rubber backed articles and clothes or pillows fitted with foam rubber pads should not be dried in the tumble dryer.
- Fabric softeners, or similar products, should be used as specified by the fabric softener instructions.
- Remove all objects from pockets such as lighters and matches.
- Never stop a tumble dryer before the end of the drying cycle unless all items are quickly removed and spread out so that the heat is dissipated.
- The final part of a tumble dryer cycle occurs without heat (cool down cycle) to ensure that the items are left at a temperature that ensures that the items will not be damaged.
- Do not dry the damaged items which contain padding or fillings.
- Only dry fabrics which are applicable to dry in the tumble dryer. Follow the instructions on the fabric label.
- If you have washed your laundry with a stain remover start an extra rinse cycle before you start the dryer.
- Do not drink or prepare food with the condensed water/ distilled water. It can cause health problems to people and pets.
- Do not sit or stand on the open door.
- Do not dry dripping wet clothes in the tumble dryer.

1.5 Internal light



WARNING!
Risk of injury.

- Visible LED radiation, do not look directly into the beam.
- The type of light bulb or halogen lamp used in this appliance is not suitable for house lighting.
- To replace the internal light, contact the Authorised Service Centre.

1.6 Care and cleaning

**WARNING!**

Risk of injury or damage to the appliance.

- Do not use water spray and steam to clean the appliance.
- Clean the appliance with a moist soft cloth. Only use neutral detergents. Do not use abrasive products, abrasive cleaning pads, solvents or metal objects.

1.7 Disposal

**WARNING!**

Risk of injury or suffocation.

- Disconnect the appliance from the mains supply.
- Cut off the mains cable and discard it.
- Remove the door catch to prevent children and pets to get closed in the appliance.

1.8 Service

- Only original spare parts can ensure the safety standards of the appliance.
- Only repairs undertaken by an Electrolux approved service technician are covered by the guarantee.

2. PRODUCT DESCRIPTION

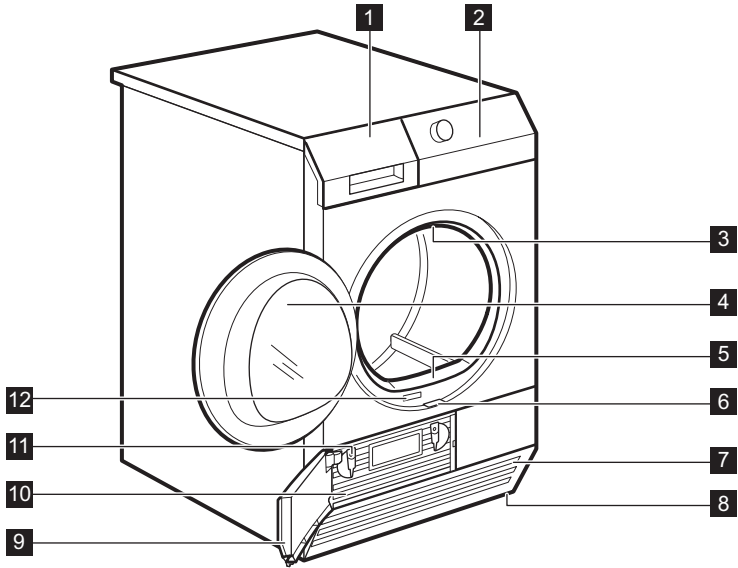

- | | |
|------------------------------------|-------------------------------------|
| 1 Water container | 8 Adjustable feet |
| 2 Control panel | 9 Condenser door |
| 3 Internal light | 10 Condenser cover |
| 4 Appliance door | 11 Locks for condenser cover |
| 5 Filter | 12 Rating plate |
| 6 Button for condenser door | |
| 7 Airflow slots | |



The load door can be installed by the user in the opposite side. It can help to easily put and remove the laundry or if there is a limit to install the appliance (see separate leaflet).

3. ACCESSORIES

3.1 Stacking kit

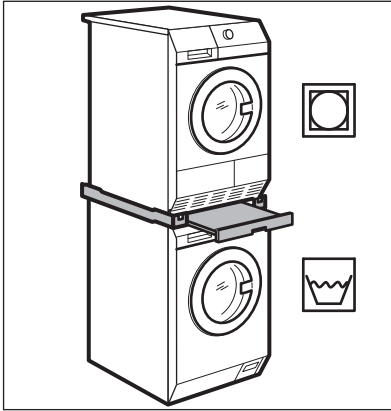

Available from your authorized vendor. Stacking kit can be used only with the washing machines specified in the leaflet. See the leaflet attached. Read carefully the instructions supplied with the accessory.

3.2 Draining kit

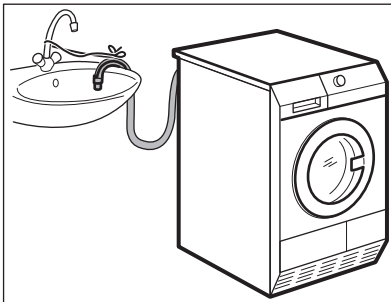

It is available from your authorized vendor (can be attached to some types of the tumble dryers)

The accessory for through draining of the condensed water into a basin, siphon, gully, etc. After the installation, the water container is drained automatically. The

water container must stay in the appliance.

The installed hose must be on the height from minimum of 50 cm to maximum of 1 m from floor level. The hose cannot be in loop. Decrease the length of the hose if necessary.

Read carefully the instructions supplied with the accessory.

3.3 Pedestal with the drawer

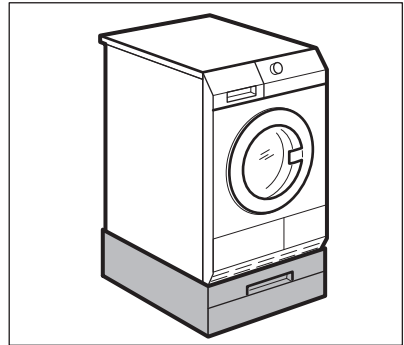

It is available from your authorized vendor.

To put the appliance higher at the level what helps to easy load and remove the laundry.

The drawer can be used for laundry storage e.g. : towels, cleaning products and more.

Read carefully the instructions supplied with the accessory.

3.4 Coin operated machine

If the appliance is set in a public place, it can be connected to a coin operated machine.

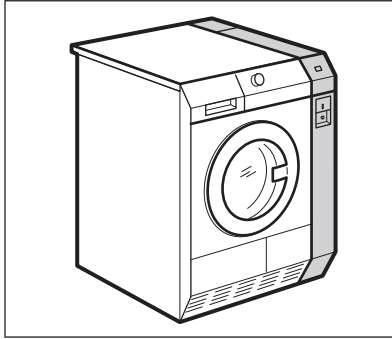

4. CONTROL PANEL

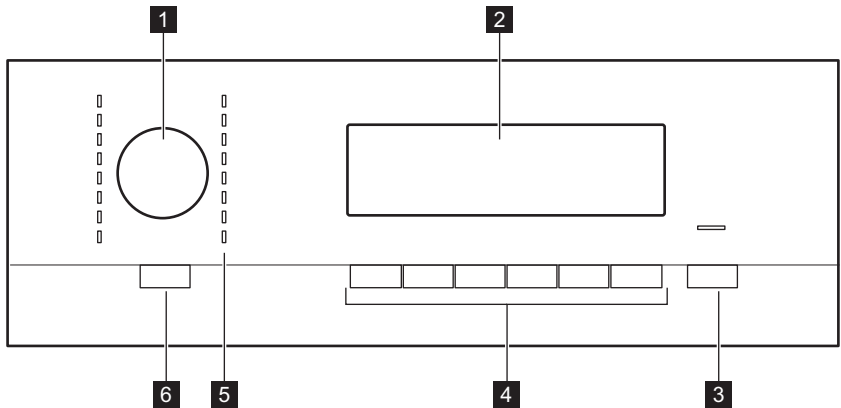

1 Programme dial

2 Display

3 ▶/|| Start/Pause button











4 Options buttons

5 Programme indicators

6 Ⓞ ON/OFF button with the Auto Off function

4.1 Display



Symbol on the display	Symbol description
1/2	half load
	dryness - extra dry
	dryness - cupboard dry
	dryness - iron dry
	indicator: <i>drain the water container</i>
	indicator: <i>clean filter</i>
	indicator: <i>do the check of the heat exchanger</i>
	indicator: <i>drying phase</i>
	indicator: <i>cooling phase</i>
	indicator: <i>crease guard phase</i>
	time dry option on
2 . 00	cycle time indication
1 . 20	time selection (5 min. steps)

5. COIN OPERATED MACHINES

1. Insert correct amount of coins. When inserting coins, the display on the coin meter will count down to "00" and the machine will be ready to start.
2. Push Start/Pause button to start the machine



6. PROGRAMME TABLE

There are two types of programmes, automatic programmes and time programmes.

Automatic programmes has moisture detection and will stop when selected dryness is achieved.



Time programmes has no moisture detection and will stop when the preset or selected time has ended.

The following table shows the available programmes and a short description of those:

Automatic programmes	Load ¹⁾	Description
Eco  ²⁾	8 kg	Cotton and terry - most efficient in terms of energy consumption. Normal/medium temperature. The programme will stop when preset dryness/selected option is achieved (Extra dry, Cupboard dry, Iron dry).
 Normal	8 kg	Cotton and terry. Normal/medium temperature. The programme will stop when preset dryness/selected option is achieved (Extra dry, Cupboard dry, Iron dry).
 Low	3,5 kg	Synthetic (example of synthetic fabrics: polyester, polyamide, polyacrylic and elastan), viscose, polycotton and delicate fabrics. Low temperature. The programme will stop when preset dryness/selected option is achieved (Extra dry, Cupboard dry, Iron dry).

1) The maximum weight refers to dry items.

2) The  Cotton Eco programme is the “Standard cotton programme” and it is suitable to dry normal wet cotton laundry and it is the most efficient programme in terms of energy consumption for drying wet cotton laundry.

Time programmes	Description
 Normal	Cotton and terry. Different drying times can be selected. The programme will stop when the time is up.
 Low	Synthetic (example of synthetic fabrics: polyester, polyamide, polyacrylic and elastan), viscose, polycotton and delicate fabrics. Different drying times can be selected. The programme will stop when the time is up.
 Airing	Airing bedspreads, duvets and bedclothes. The programme will stop when the time is up.

7. OPTIONS

7.1 Half load

Use this option if you dry half load of the laundry .

7.2 Extra dry

This option helps to get the laundry extra dried.

7.3 Cupboard dry

This option assure that the laundry after drying process is ready to store.

7.4 Iron dry

This option assure that the laundry after drying process is suitable to iron.

7.5 Care

Extends anti-crease phase (30 minutes) at the end of the drying cycle to 90 minutes. This option prevents laundry from creases. Laundry can be removed during the anti-crease phase.

7.6 Time

Lets the user to increase time of drying in 5 min. steps.

8. BEFORE FIRST USE





Before you use the appliance for the first time do these operations:

- Clean the tumble dryer drum with a moist cloth.
- Start a short programme (e.g. 30 minutes) with moist laundry.

9. DAILY USE

9.1 Preparing the laundry

- Close the zippers.
- Close the fasteners of the duvet covers.
- Do not keep ties or ribbons loose (e.g. apron ribbons). Tie them before you start a programme.
- Remove all items from the pockets.
- If an item has the internal layer made of cotton, turn it inside out. Make sure that the cotton layer is always external
- We recommend that you set the correct programme applicable for the type of fabrics that are in the appliance.
- Do not put fabrics with strong colours together with fabrics with light colours. Strong colours can bleed.
- Use an applicable programme for cotton jersey and knitwear to prevent the items to shrink.
- Make sure that the laundry weight is not more than the maximum weight that is in the programme table.
- Dry only the laundry that is applicable for tumble dryer. Refer to the fabric label on the items.

Fabric label	Description
	Laundry that is applicable for tumble drying.
	Laundry that is applicable for tumble drying and resists higher drying temperature.
	Laundry that is applicable for tumble drying but only with low drying temperature.
	Laundry that is not applicable for tumble drying.

9.2 Loading the laundry



CAUTION!

Do not lock the laundry in between the appliance door and rubber seal.

1. Pull the appliance door.
2. Load loosely the laundry.

3. Close the appliance door.

9.3 Turning on the appliance

To turn on the appliance:

Push the ON/OFF button.

If the appliance is on, some indications come in to the view on the display.

9.4 Auto Off function

To decrease the energy consumption, the Auto Off function turns off automatically the appliance:

- if the Start/Pause button was not pressed in the time of 5 minutes.
- after 5 minutes from the programme end.

Push the **ON/OFF** button to turn on the appliance.

If the appliance is on, some indications come in to the view on the display.

9.5 Setting a programme

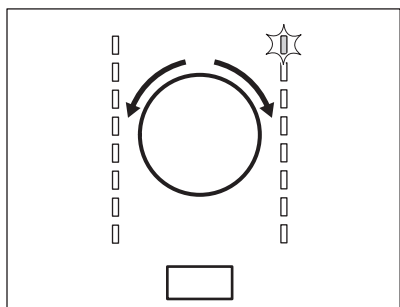

Use the programme dial to set the programme.

The time to the programme end comes into the view on the display.

9.6 Options

Together with the programme you can set 1 or more special options.

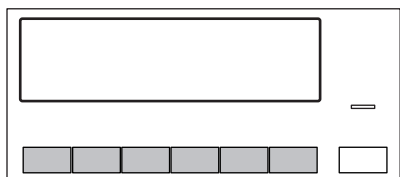

To activate or deactivate the option push the applicable button .

When the option is activated the LED above the button or symbol on the display comes into the view.

9.7 Starting a programme

To start the programme:

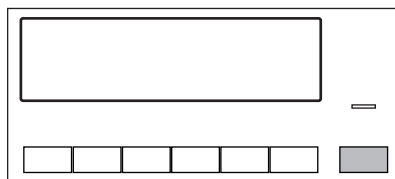

Push the **Start/Pause** button.

The appliance starts and the LED above the button does not flash but is stable.

9.8 Programme change

To change a programme:

1. Push the ON/OFF button to turn off the appliance.
2. Push again the ON/OFF button to turn on the appliance.
3. Set a new programme.

9.9 Programme end

- i** Clean the filter and drain the water container after each drying cycle. (See chapter CARE AND CLEANING.)

If the drying cycle is completed, the symbol  flashes on the display and the acoustic signal sounds intermittently for 1 minute.

- i** If you do not turn off the appliance, the crease guard phase starts. Laundry can be removed during this phase.

To remove the laundry:

1. Push the **ON/OFF** button for 2 seconds to turn off the appliance.
2. Open the appliance door.
3. Remove the laundry.
4. Close the appliance door.

10. HINTS AND TIPS

10.1 Ecological hints

- Spin good the laundry before drying.
- Use the load volumes which are specified in the programme chart.
- Clean the filter after each drying cycle.
- Do not use fabric softener to wash and then dry. In the tumble dryer laundry becomes soft automatically.
- Use the condensate as distilled water, e.g. for steam ironing. If it is necessary clean the condensate before (e.g. with a coffee filter) to remove possible small pieces of fluff.
- Always keep the airflow slots on the bottom of the appliance clear.
- Make sure that is good airflow in the appliance installation position.

10.2 Adjustment of the remaining laundry moisture degree

To change the default degree of the remaining moisture of the laundry:

1. Turn on the appliance.
2. Wait approximately 8 seconds.
3. Select 1 of available programmes.
4. Push at the same time and hold down the **Half load** and **Cupboard dry** buttons.

One of the symbols goes into the view on the display:

 - the maximum dry laundry

 - the more dry laundry

 - the standard dry laundry

5. Push the  Start/Pause button again and again until you set necessary degree.
6. To memorise the setting, push at the same time the **Half load** and **Cupboard dry** buttons for approximately 2 seconds.





10.3 Deactivating the Reservoir indicator

The water container indicator is by default on. It starts to light at the end of the drying cycle or during the cycle if the water reservoir is full. If the draining kit is installed the water container is drained automatically and indicator can be permanently off.

To deactivate the indicator:

1. Turn on the appliance.
2. Wait approximately 8 seconds.
3. Select 1 of available programmes.
4. Push at the same time and hold down the **Half load** and **Iron dry** buttons.

One of 2 configurations is possible:

- the Reservoir indicator:  is on and the symbol  goes into the view - the water container indicator is permanently **on**
- the Reservoir indicator:  is off and the symbol  goes into the view - the water container indicator is permanently **off**

11. CARE AND CLEANING

11.1 Cleaning the filter

At the end of each cycle the symbol  *Filter* is on the display and you must clean the filter.

-  The symbol  flashes on the display - the filter is missing. The tumble dryer cannot start.



The filter collects the fluff. The fluff occurs while the clothes are dried in the tumble dryer.

To clean the filter:

1. Open the door. Pull the filter.

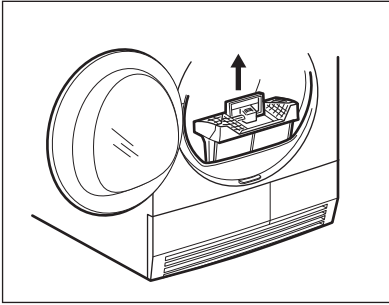

2. Push the button.

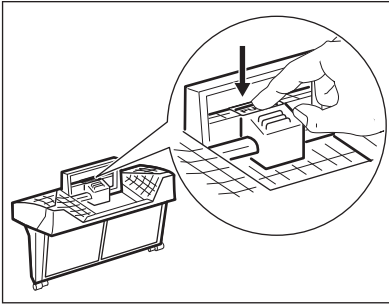

3. Open the filter.

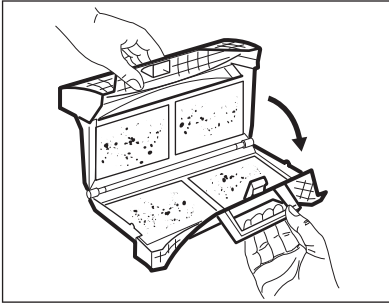

4. Use a moist hand to clean the filter.

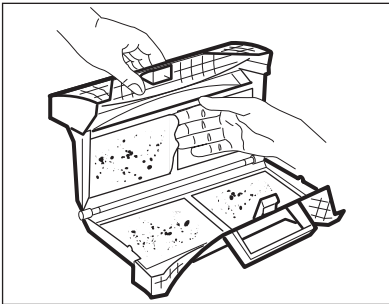

5. If necessary clean the filter with the brush under warm tap water and/or a vacuum cleaner. Close the filter.

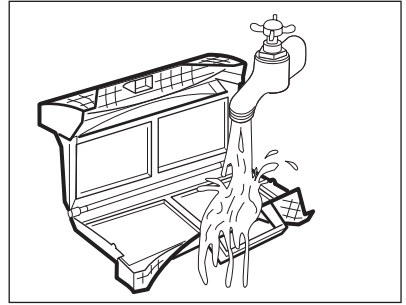

6. If necessary remove fluff from the filter socket and gasket. You can use a vacuum cleaner. Put the filter inside the filter socket.

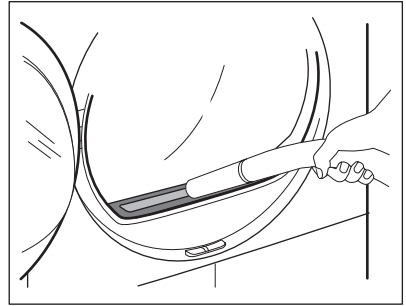

11.2 Draining the water container

Drain the condensed water container after each drying cycle.

If the condensed water container is full, the programme breaks off automatically.

The symbol  Reservoir is on the display and you must drain the water container.

To drain the water container:

1. Pull the water container and keep it in horizontal position.

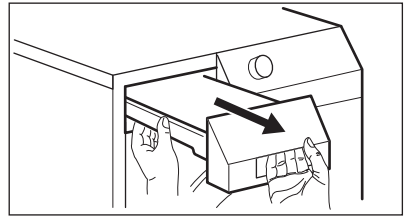

2. Move the plastic connection out and drain the water into a basin or

equivalent receptacle.

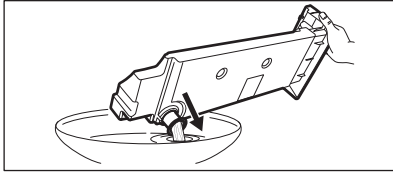

3. Move plastic connection in and install water container.
4. To continue the programme press the Start/Pause button.

11.3 Cleaning the condenser

If the symbol \Rightarrow *Condensor* flashes on the display, the condenser and its compartment must be cleaned.

To clean the condenser and its compartment:

1. Open the door.
2. Move the release button on the bottom of the door to open the condenser door.

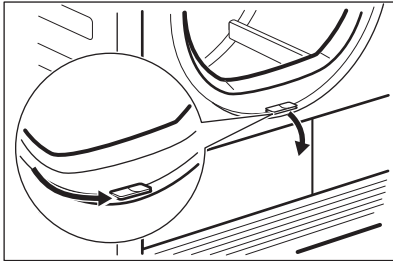

3. Turn 2 blockages to unlock the condenser cover.

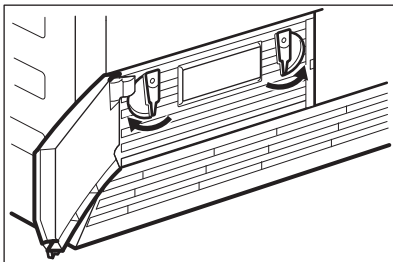

4. Lower the condenser cover.

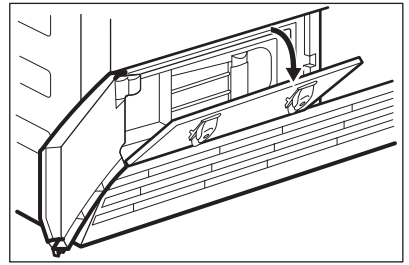

5. Catch the handle and pull the condenser out from the bottom compartment. Move condenser horizontally to do not spill remaining water.

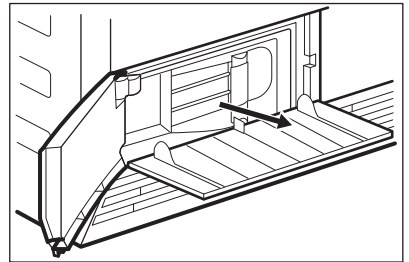

6. Clean the condenser in vertical position over a basin or paddling. Rinse through with a hand shower.

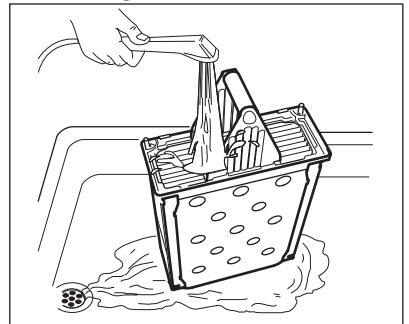

7. Put the condenser back inside the bottom compartment.
8. Close the condenser cover.
9. Lock 2 blockages until they snap.
10. Close the condenser door.

11.4 Cleaning the drum



WARNING!

Disconnect the appliance before you clean it.

Use a standard neutral soap detergent to clean the inner surface of the drum and drum ribs. Dry the cleaned surfaces with a soft cloth.



CAUTION!

Do not use abrasive materials or steel wool to clean the drum.

11.5 Cleaning the control panel and housing

Use a standard neutral soap detergent to clean the control panel and housing.

Use a moist cloth to clean. Dry the cleaned surfaces with a soft cloth.









CAUTION!

Do not use furniture cleaning agents or cleaning agents which can cause corrosion to clean the appliance.

11.6 Cleaning the airflow slots

Use a vacuum cleaner to remove the fluff from the airflow slots.

12. TROUBLESHOOTING

Problem 1)	Possible cause	Remedy
The tumble dryer does not operate.	The tumble dryer is not connected to mains supply.	Connect in at mains socket. Check fuse in fuse box (domestic installation).
	The loading door is opened.	Close the loading door.
	The  ON/OFF button was not pushed.	Push the  ON/OFF button.
	The  /  Start/Pause button was not pushed.	Push the  /  Start/Pause button.
	The appliance is in the standby mode.	Push the  ON/OFF button.
	The filter is missed or in wrong position.	Insert the filter in the right position.
	The E59 error code on the display - dryer overloaded.	Unload part of the laundry. Obey the maximum load.

Problem 1)	Possible cause	Remedy
Unsatisfactory drying result.	Incorrect programme selection.	Do the selection of the applicable programme. 2)
	The filter is clogged.	Clean the filter. 3)
	Too high volume of the load.	Obey the maximum load volume.
	The airflow grill is clogged.	Clean the airflow grill in the bottom of the appliance.
	Dirt on the humidity sensor in the drum.	Clean the front surface of the drum.
	Incorrect remaining laundry moisture degree.	Adjust remaining laundry moisture degree. 4)
	The condenser is clogged.	Clean the condenser. 3)
The loading door does not closed	The filter not locked in the position.	Put the filter in the correct position.
	The laundry is locked between the door and the seal.	Put the load correctly in the drum.
Err (Error) on the display.	You try to change the programme or the option after the start of the cycle.	Turn the tumble dryer off and on. Make the new selection.
	The option you try to activate is not applicable with the selected programme.	Turn the tumble dryer off and on. Make the new selection.
No drum light	Defective drum lamp.	Contact the service centre to replace the drum lamp.
Abnormally elapsing time on the display.	The time to end is calculated on the basis of the volume and dampness of the laundry.	The automatic procedure — this is not the appliance malfunction.
Programme inactive.	The water container is full.	Drain the water container, push the  Start/Pause button. 3)
Drying cycle too short.	Too small laundry volume.	Do the selection of time programme. The time value must be related to the load. To dry 1 item or small quantities of the laundry we recommend to use short times.
	The laundry is too dry.	Do the selection of the time programme with longer time.

Problem 1)	Possible cause	Remedy
Drying cycle too long 5)	The filter is clogged.	Clean the filter.
	Too high the laundry load.	Obeys the maximum load.
	The laundry not spun sufficiently.	Spin correctly the laundry.
	Very high room temperature - this is not the appliance malfunction.	If possible, lower the room temperature.

1) If there is an error message on the display (e.g. **E51**): Turn the tumble dryer off and on.

Make a selection of the new programme. Push the  Start/Pause button. Does not operate? - contact the service centre and give the error code.

2) Follow the programme description — see PROGRAMME TABLE

3) See chapter CARE AND CLEANING

4) See HINTS AND TIPS chapter

5) Note: After maximum 5 hours the drying cycle ends automatically.

13. TECHNICAL DATA

Height x Width x Depth	850 x 600 x 605 mm (maximal 648 mm)
Max. depth with the appliance door open	1072 mm
Max. width with the appliance door open	950 mm
Adjustable height	850 mm (+ 15 mm - feet regulation)
Drum volume	118 l
Maximum load volume	8 kg
Emission sound pressure level in accordance with EN ISO 11204/11203	<70 dB
Voltage	230-240 V
Frequency	50 Hz
Necessary fuse	13 A
Total power	2800 W
Energy efficiency class	B
Energy consumption ¹⁾	4,77 kWh
Annual energy consumption ²⁾	560 kWh
Left—on mode power absorption	0,12 W
Off mode power absorption	0,12 W
Permitted ambient temperature	+ 5°C to + 35°C

Level of protection against ingress of solid particles and moisture ensured by the protective cover, except where the low voltage equipment has no protection against moisture **IPX4**

- 1) With reference to EN 61121. 8kg of cotton centrifuged at 1000 rpm.
- 2) Energy consumption per year in kWh, based on 160 drying cycles of the standard cotton programme at full and partial load, and the consumption of the low-power modes. Actual energy consumption per cycle will depend on how the appliance is used (REGULATION (EU) No 392/2012).

14. ENVIRONMENT CONCERNS

Recycle the materials with the symbol . Put the packaging in applicable containers to recycle it. Help protect the environment and human health and to recycle waste of electrical and electronic appliances. Do

not dispose appliances marked with the symbol  with the household waste. Return the product to your local recycling facility or contact your municipal office.

CE

136934760-C-012015



Electrolux Professional S.p.A.
Viale Treviso, 15 -33170 Pordenone
Italy

www.electrolux.com/myPRO

Share more of our thinking at
www.electrolux.com