

CM1109

# Microwave Oven

(COMMERCIAL)

Owner's instructions & Cooking guide

imagine the possibilities

Thank you for purchasing this Samsung product.  
Please register your product at

[www.samsung.com/register](http://www.samsung.com/register)

**SAMSUNG**

## USING THIS INSTRUCTION BOOKLET

---

You have just purchased a SAMSUNG microwave oven. Your owner's Instructions contain valuable information on cooking with your microwave oven:

- Safety precautions
- Suitable accessories and cookware
- Useful cooking tips
- Cooking tips

## LEGEND FOR SYMBOLS AND ICONS

---



WARNING

Hazards or unsafe practices that may result in **severe personal injury or death**



CAUTION

Hazards or unsafe practices that may result in **minor personal injury or property damage**



Warning; Fire hazard



Warning; Hot surface



Warning; Electricity



Warning; Explosive material



Do NOT attempt



Do NOT touch



Do NOT disassemble



Follow directions explicitly



Unplug the power plug from the wall socket



Make sure the machine is grounded to prevent electric



Call the service center for help



Note



Important

## IMPORTANT SAFETY INSTRUCTIONS

---

### READ CAREFULLY AND KEEP FOR FUTURE REFERENCE.

Make sure that these safety precautions are obeyed at all times.

**Before using the oven, confirm that the following instructions are followed.**

#### WARNING (Microwave function only)

 **WARNING:** If the door or door seals are damaged, the oven must not be operated until it has been repaired by a competent person.

---

 **WARNING:** It is hazardous for anyone other than a competent person to carry out any service or repair operation that involves the removal of a cover which gives protection against exposure to microwave energy.

---

 **WARNING:** Liquids and other foods must not be heated in sealed containers since they are liable to explode.

---

 This appliance is intended to be used in household only.

---

 **WARNING:** This appliance can be used by children aged from 8 years and above and persons with

reduced physical, sensory or mental capabilities or lack of experience and knowledge if they have been given supervision or instruction concerning use of the appliance in a safe way and understand the hazards involved. Children shall not play with the appliance. Cleaning and user maintenance shall not be made by children unless they are aged from 8 years and above and supervised.

---

 **WARNING:** Only allow children to use the oven without supervision when adequate instructions have been given so that the child is able to use the oven in a safe way and understand that hazards of improper use.

---

 Only use utensils that are suitable for use in microwave ovens.

---

 When heating food in plastic or paper containers, keep an eye on the oven due to the possibility of ignitions.

---

 The microwave oven is intended for heating food and beverages. Drying of food or clothing and heating of warming pads, slippers, sponges, damp cloth and similar may lead to risk of injury, ignition or fire.

---

 If smoke is emitted, switch off or unplug the appliance and keep the door closed in order to stifle

any flames.

---

**WARNING:** Microwave heating of beverages can result in delayed eruptive boiling, therefore care must be taken when handling the container.

---

**WARNING:** The contents of feeding bottles and baby food jars shall be stirred or shaken and the temperature checked before consumption, in order to avoid burns.

---

Eggs in their shell and whole hard-boiled eggs should not be heated in microwave ovens since they may explode, even after microwave heating has ended.

---

The oven should be cleaned regularly and any food deposits removed.

---

Failure to maintain the oven in a clean condition could lead to deterioration of the surface that could adversely affect the life of the appliance and possibly result in a hazardous situation.

---

The appliance is not intended for installing in road vehicles, caravans and similar vehicles etc.

---

This appliance is not intended for use by persons (including children) with reduced physical, sensory or mental capabilities, or lack of experience

and knowledge, unless they have been given supervision or instruction concerning use of the appliance by a person responsible for their safety.

---

Children should be supervised to ensure that they do not play with the appliance.

---

If the supply cord is damaged, it must be replaced by the manufacturer, its service agent or similarly qualified persons in order to avoid a hazard.

---

**Warning:** Liquids or other foods must not be heated in sealed containers since they are liable to explode;

---

The appliance should not be cleaned with a water jet.

---

This oven should be positioned proper direction and height permitting easy access to cavity and control area.

---

Before using the oven first time, oven should be operated with the water during 10 minute and then used.

---

If the oven generates a strange noise, a burning smell, or smoke is emitted, unplug the power plug immediately and contact your nearest service center.

---

The microwave oven has to be positioned so that plug is accessible.

---

The microwave oven is intended to be used on the counter or counter top use only, the microwave oven shall not be placed in a cabinet.



## WARNING

(Oven function only)- Optional

**Warning:** When the appliance is operated in the combination mode, children should only use the oven under adult supervision due to the temperatures generated.

---

During use the appliance becomes hot. Care should be taken to avoid touching heating elements inside the oven.

---

**Warning:** Accessible parts may become hot during use. Young children should be kept away.

---

A steam cleaner is not to be used.

---

**Warning:** Ensure that the appliance is switched off before replacing the lamp to avoid the possibility of electric shock.

---

**Warning:** The appliance and its accessible parts

become hot during use. Care should be taken to avoid touching heating elements.

Children less than 8 years of age shall be kept away unless continuously supervised.

---

- This appliance can be used by children aged from 8 years and above and persons with reduced physical, sensory or mental capabilities or lack of experience and knowledge if they have been given supervision or instruction concerning use of the appliance in a safe way and understand the hazards involved. Children shall not play with the appliance. Cleaning and user maintenance shall not be made by children without supervision.
- 

- Do not use harsh abrasive cleaners or sharp metal scrapers to clean the oven door glass since they can scratch the surface, which may result in shattering of the glass.
- 

- The temperature of accessible surfaces may be high when the appliance is operating.
- 

- The door or the outer surface may get hot when the appliance is operating.
- 

- Keep the appliance and its cord out of reach of children less than 8 years.
- 

- Appliances are not intended to be operated by



means of an external timer or separate remote-control system.

---

This product is a Group 2 Class A ISM equipment. The definition of group 2 which contains all ISM equipment in which radio-frequency energy is intentionally generated and/or used in the form of electromagnetic radiation for the treatment of material, and EDM and arc welding equipment. For Class A equipment is equipment suitable for use in all establishments other than domestic and those directly connected to a low voltage power supply network which supplies buildings used for domestic purposes.

**Warning:** Class A equipment is intended for use in industrial environment. There may be potential difficulties in ensuring electromagnetic compatibility in other environments, due to conducted as well as radiated disturbances.

## **INSTALLING YOUR MICROWAVE OVEN**

---

Place the oven on a flat level surface 85 cm above the floor. The surface should be strong enough to safely bear the weight of the oven.

1. When you install your oven, make sure there is adequate ventilation for your oven by leaving at least 10 cm(4 inches) of space behind and, on the sides of the oven and 20 cm(8 inches) of space above.
2. Remove all packing materials inside the oven.
3. Install the roller ring and turntable. Check that the turntable rotates freely.

(Turntable type model only)

4. This microwave oven has to be positioned so that the plug is accessible.

 If the supply cord is damaged, it must be replaced by the manufacturer, its service agent or similarly qualified persons in order to avoid a hazard.

 For your personal safety, plug the cable into a proper AC earthed socket.

Do not install the microwave oven in hot or damp surroundings like next to a traditional oven or radiator. The power supply specifications of the oven must be respected and any extension cable used must be of the same standard as the power cable supplied with the oven. Wipe the interior and the door seal with a damp cloth before using your microwave oven for the first time.

## **CLEANING YOUR MICROWAVE OVEN**

---

The following parts of your microwave oven should be cleaned regularly to prevent grease and food particles from building up:

- Inside and outside surfaces
- Door and door seals
- Turntable and Roller rings  
(Turntable type model only)



**ALWAYS** ensure that the door seals are clean and the door closes properly.



Failure to maintain the oven in a clean condition could lead to deterioration of the surface that could adversely affect the life of the appliance and possibly result in a hazardous situation.

1. Clean the outside surfaces with a soft cloth and warm, soapy water. Rinse and dry.
2. Remove any splashes or stains on the inside surfaces of oven with a soapy cloth. Rinse and dry.
3. To loosen hardened food particles and remove smells, place a cup of diluted lemon juice in the oven and heat for ten minutes at maximum power.
4. Wash the dishwasher-safe plate whenever necessary.



**DO NOT** spill water in the vents. **NEVER** use any abrasive products or chemical solvents. Take particular care when cleaning the door seals to ensure that no particles:

- Accumulate
- Prevent the door from closing correctly

 **Clean** the microwave oven cavity right after each use with a mild detergent solution, but let the microwave oven cool down before cleaning in order to avoid injury.

## STORING AND REPAIRING YOUR MICROWAVE OVEN

---

A few simple precautions should be taken when storing or having your microwave oven serviced.

The oven must not be used if the door or door seals are damaged:

- Broken hinge
- Deteriorated seals
- Distorted or bent oven casing

Only a qualified microwave service technician should perform repair

 **NEVER** remove the outer casing from the oven. If the oven is faulty and needs servicing or you are in doubt about its condition:

- Unplug it from the wall socket
- Contact the nearest after-sales service centre

 If you wish to store your own away temporarily, choose a dry, dustfree place.

**Reason:** Dust and damp may adversely affect the working parts in the oven.

 This microwave oven is not intended for commercial use.

 This light bulb should not be placed in person for safety reasons.

Please contact nearest authorised Samsung customer care, to arrange for a qualified engineer to replace the bulb.

# ! WARNING



	Only qualified staff should be allowed to modify or repair the appliance.	✓	✓	✓	✓
	Do not heat liquids and other food in sealed containers for Microwave function.		✓	✓	✓
	For your safety, do not use high-pressure water cleaners or steam jet cleaners.	✓	✓	✓	✓
	Do not install this appliance; near heater, inflammable material; in a humid, oily or dusty location, in a location exposed to direct sunlight and water or where gas may leak; on un level ground.	✓	✓	✓	✓
	This appliance must be properly grounded in accordance with local and national codes.	✓	✓	✓	✓
	Remove all foreign substances such as dust or water from the power plug terminals and contact points using a dry cloth on a regular basis.	✓	✓	✓	✓
	Do not pull or excessively bend or place heavy objection the power cord.	✓	✓	✓	✓
	In the event of a gas leak (such as propane gas, LP gas, etc.), ventilate immediately without touching the power plug.	✓	✓	✓	✓
	Do not touch the power plug with wet hands.	✓	✓	✓	✓
	Do not turn the appliance off by unplugging the power plug while an operation is in progress.	✓	✓	✓	✓
	Do not insert fingers or foreign substances, if any foreign substance such as water has entered the appliance, unplug the power plug and contact your nearest service centre.	✓	✓	✓	✓
	Do not apply excessive pressure or impact to the appliance.	✓	✓	✓	✓
	Do not place the oven over a fragile object such as a sink or glass object.	✓	✓		
	Do not use benzene, thinner, alcohol, steam cleaner or high pressure cleaner to clean the appliance.	✓	✓	✓	✓
	Ensure that the power voltage, frequency and current are the same as those of the product specifications.	✓	✓		✓
	Plug the power plug into the wall socket firmly. Do not use a multiple plug adapter an extension cord or an electric transformer.	✓	✓	✓	
	Do not hook the power cord on a metal object, insert the power cord between the objects or behind the oven.	✓	✓	✓	
	Do not use a damaged power plug, damaged power cord or loose wall socket. When the power plug or power cord is damaged, contact your nearest service centre.	✓	✓	✓	✓

<input type="checkbox"/>	Do not pour or directly spray water onto the oven.	✓	✓		
<input type="checkbox"/>	Do not place objects on the oven, inside or on the door of the oven.	✓	✓	✓	
<input type="checkbox"/>	Do not spray volatile material such as insecticide onto the surface of the oven.	✓	✓		
<input type="checkbox"/>	Do not store flammable materials in the oven. Take special care when heating dishes or drinks that contain alcohol as alcohol vapours may contact a hot part of the oven.	✓		✓	✓
<input checked="" type="checkbox"/>	Keep children away from the door when opening or closing it as they may bump themselves on the door or catch their fingers in the door.	✓	✓	✓	✓
<input checked="" type="checkbox"/>	<p>WARNING: Microwave heating of beverages can result in delayed eruptive boiling, therefore care must be taken when handling the container; To prevent this situation ALWAYS allow a standing time of at least 20 seconds after the oven has been switched off so that temperature can equalize. Stir during heating, if necessary, and ALWAYS stir after heating. In the event of scalding, follow these FIRST AID instructions:</p> <ul style="list-style-type: none"> <li>● Immerse the scalded area in cold water for at least 10 minutes.</li> <li>● Cover with a clean, dry dressing.</li> <li>● Do not apply any creams, oils or lotions.</li> </ul>	✓	✓	✓	✓
<input type="checkbox"/>	Don't put the tray or rack in water shortly after cooking because it may cause breakage or damage of the tray or rack.				✓
<input type="checkbox"/>	Don't operate the microwave oven for deep fat frying because the oil temperature cannot be controlled. This could result in a sudden boil over of the hot liquid.	✓			✓

# CAUTION



★	<p>Only use utensils that are suitable for use in microwave ovens; DO NOT use any metallic containers, Dinnerware with gold or silver trimming, skewers, fork, etc. Remove wire twist ties from paper or plastic bags. Reason: Electric arcing or sparking may occur and may damage the oven.</p>	✓	✓	✓
☐	<p>Do not use your microwave oven to dry papers or clothes.</p>	✓	✓	✓
★	<p>Use shorter times for smaller amounts of food to prevent overheating and burning food.</p>	✓	✓	✓
☐	<p>Do not immerse the power cable or power plug in water and keep the power cable away from heat.</p>	✓	✓	
☐	<p>Eggs in their shell and whole hard-boiled eggs should not be heated in microwave ovens since they may explode, even after microwave heating has ended; Also do not heat airtight or vacuum-sealed bottles, jars, containers, nuts in shells, tomatoes etc.</p>		✓	✓
☐	<p>Do not cover the ventilation slots with cloth or paper. They may catch fire as hot air escapes from the oven. The oven may also overheat and switch itself off automatically, and will remain off until it cools sufficiently.</p>	✓	✓	
☐	<p>Always use oven mitts when removing a dish from the oven To avoid unintentional burns.</p>		✓	
★	<p>Stir liquids halfway during heating or after heating ends and allow the liquid stand at least 20 seconds after heating to prevent eruptive boiling.</p>		✓	
★	<p>Stand at arms length from the oven when opening the door to avoid getting scalded by escaping hot air or steam.</p>		✓	
☐	<p>Do not operate the microwave oven when it is empty. The microwave oven will automatically shut down for 30 minutes for safety purposes. We recommend placing a glass of water inside the oven at all times to absorb microwave energy in case the microwave oven is started accidentally.</p>	✓		✓
★	<p>Install the oven in compliance with the clearances stated in this manual. (See installing your microwave oven.)</p>	✓	✓	
★	<p>Take care when connecting other electrical appliances to sockets near the oven.</p>	✓	✓	✓



## **INSTALLATION & WIRING INSTRUCTIONS**

---

### **IMPORTANT NOTE:**

The mains lead on this equipment is supplied with a moulded plug incorporating a fuse. The value of the fuse is indicated on the pin face of the plug and, if it requires replacing, a fuse approved to BS 1363 of the same rating must be used. Never use the plug with the fuse cover omitted if the cover is detachable. If a replacement fuse cover is required, it must be of the same colour as the pin face of the plug. Replacement covers are available from your Dealer. If the fitted plug is not suitable for the power points in your house or the cable is not long enough to reach a power point, you should obtain a suitable safety approved extension lead or consult your Dealer for assistance. However, if there is no alternative to cutting off the plug, remove the fuse and then safely dispose of the plug. Do not connect the plug to a mains socket, as there is a risk of shock hazard from the bared flexible cord.

## **PRECAUTIONS TO AVOID POSSIBLE EXPOSURE TO EXCESSIVE MICROWAVE ENERGY.(MICROWAVE FUNCTION ONLY)**

Failure to observe the following safety precautions may result in harmful exposure to microwave energy.

- (a) Under no circumstances should any attempt to made to operate the oven with the door open or to tamper with safety interlocks (door latches) or to insert anything into the safety interlock holes.
- (b) Do NOT place any object between the oven door front face or allow food or cleaner residues to accumulate on sealing surfaces. Ensure that the door and door sealing surfaces are kept clean by wiping after use first with a damp cloth and then with a soft dry cloth.
- (c) Do Not operate the oven if it is damaged until it has been repaired by a qualified microwave service technician trained by the manufacturer. It is particularly important that the oven door closes properly and that there is no damage to the:
  - (1) door(bent)
  - (2) door hinges(broken or loose)
  - (3) door seals and sealing surfaces
- (d) The oven should not be adjusted or repaired by anyone other than a properly qualified microwave service technician trained by the manufacturer.

Samsung will charge a repair fee for replacing an accessory or repairing a cosmetic defect if the damage to the unit and/or damage to or loss of the accessory was caused by the customer. Items this stipulation covers include:

- (a) A Dented, Scratched, or Broken Door, Handle, Out-Panel, or Control Panel
  - (b) A Broken or missing Tray, Guide Roller, Coupler, or Wire Rack.
- Use this appliance only for its intended purpose as described in this instruction manual. Warnings and Important Safety Instructions in this manual do not cover all possible conditions and situations that may occur. It is your responsibility to use common sense, caution, and care when installing, maintaining, and operating your appliance.

- Because these following operating instructions cover various models, the characteristics of your microwave oven may differ slightly from those described in this manual and not all warning signs may be applicable. If you have any questions or concerns, contact your nearest service centre for help and information online at [www.samsung.com](http://www.samsung.com).
- This microwave oven is supposed for heating food. It is intended for domestic home-use only. Do not heat any type of textiles or cushions filled with grains. Which could cause burns and fire. The manufacturer cannot be held liable for damage caused by improper or incorrect use of the appliance.
- Failure to maintain the oven in a clean condition could lead to deterioration of the surface that could adversely affect the life of the appliance and possibly result in a hazardous situation.



## **CORRECT DISPOSAL OF THIS PRODUCT**

### **(WASTE ELECTRICAL & ELECTRONIC EQUIPMENT)**

---

#### **(Applicable in countries with separate collection systems)**

This marking on the product, accessories or literature indicates that the product and its electronic accessories (e.g. charger, headset, USB cable) should not be disposed of with other household waste at the end of their working life. To prevent possible harm to the environment or human health from uncontrolled waste disposal, please separate these items from other types of waste and recycle them responsibly to promote the sustainable reuse of material resources.

Household users should contact either the retailer where they purchased this product, or their local government office, for details of where and how they can take these items for environmentally safe recycling.

Business users should contact their supplier and check the terms and conditions of the purchase contract. This product and its electronic accessories should not be mixed with other commercial wastes for disposal.

For information on Samsung's environmental commitments and product specific regulatory obligations e.g. REACH visit:

[Samsung.com/uk/aboutsamsung/samsungelectronics/corporatecitizenship/data\\_corner.html](https://www.samsung.com/uk/aboutsamsung/samsungelectronics/corporatecitizenship/data_corner.html)

## **CONTENTS**

---

Using this instruction booklet.....	1
Legend for symbols and icons.....	1
Important safety instructions.....	2
Installing your microwave oven.....	9
Cleaning your microwave oven.....	10
Storing and repairing your microwave oven.....	12
Installation & wiring instructions.....	16
Precautions to avoid possible exposure to excessive microwave energy.....	17
Correct disposal of this product.....	18
Quick look-up guide.....	21
Oven.....	22
Control panel.....	23
Checking that your oven is operating correctly.....	24
Cooking/reheating.....	24
Using the start and +30 sec button.....	25
Using the stop/cancel button.....	25
Setting cooking time and power level.....	26
Power levels.....	27
Using rapid defrost button.....	28
Memory programming.....	30
Using the check button.....	32
Resetting the memory program cycle counter.....	34
Setting the sound.....	34
Using the double quantity button.....	35
Cookware guide.....	36
Cooking guide.....	38
Troubleshooting.....	43
Technical specifications.....	45

## QUICK LOOK-UP GUIDE

---

### If you want to cook some food.

1. Place the food in the oven.  
Select the power level by pressing the **Power Level** button once or more time.



2. Select the cooking time by pressing the **Number** buttons as required (Max:30mins).

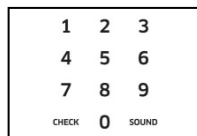

3. Press **Start** button  
**Result:** Cooking starts. The oven beeps four times when cooking is over.



### If you want to defrost some food.

1. Place the frozen food in the oven.  
Press the **Defrost** button.



2. Select the cooking time by pressing the **Number** buttons as required (Max:30mins).

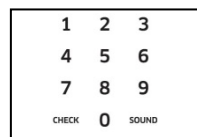

3. Press **Start** button.  
**Result:** Cooking starts. The oven beeps four times when cooking is over.



### If you want to adjust the cooking time.

- Leave the food in the oven.  
Press **+30s** once or more times for each extra 30 seconds.



# OVEN

---

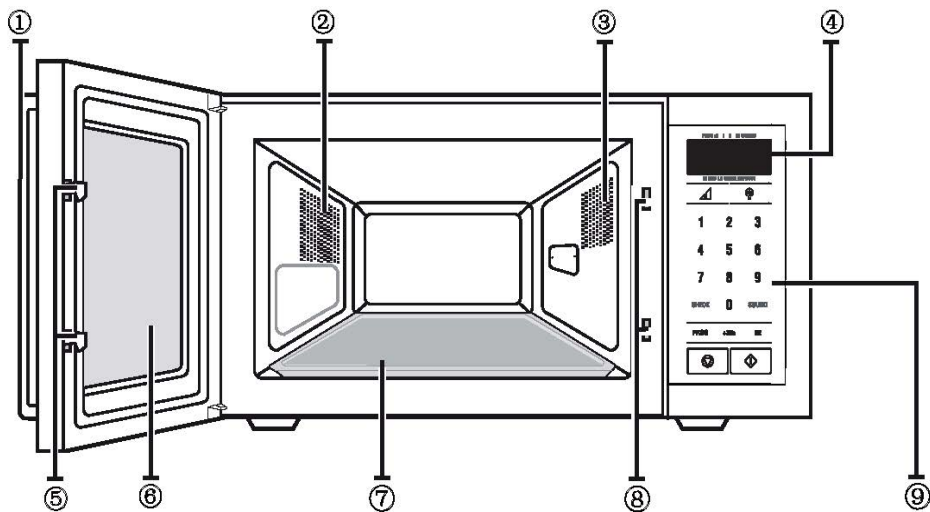

1. HANDLE

2. VENTILATION HOLES

3. OVEN LAMP

4. DISPLAY

5. DOOR LATCHES

6. DOOR

7. CERAMIC PLATE

8. SAFETY INTERLOCK HOLES

9. CONTROL PANEL

# CONTROL PANEL

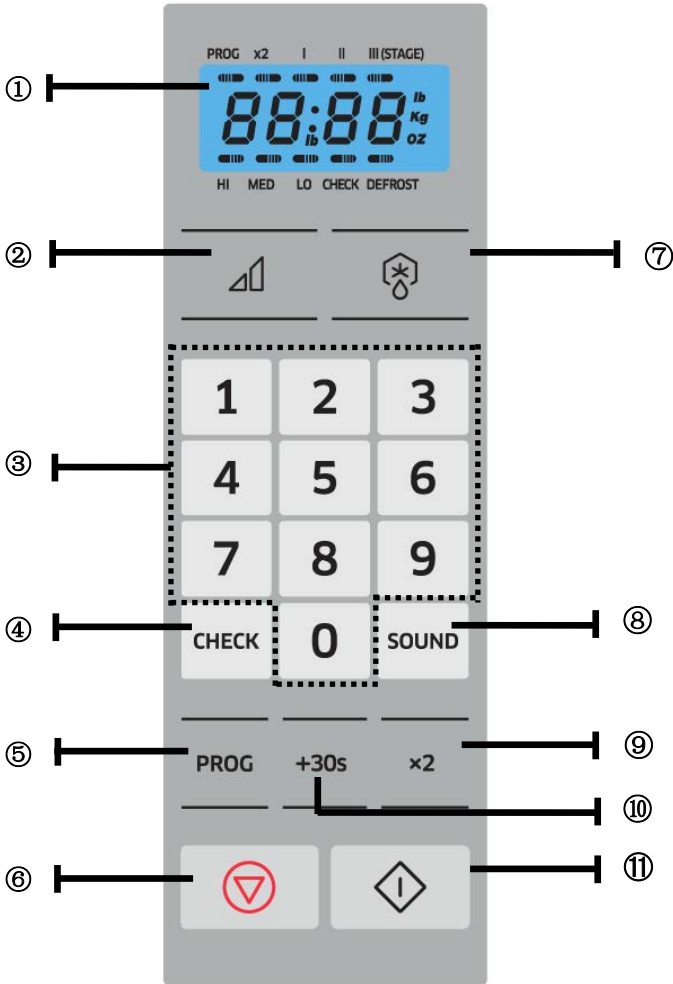

- |                        |                           |
|------------------------|---------------------------|
| 1. DISPLAY             | 7. DEFROST BUTTON         |
| 2. POWER LEVEL BUTTON  | 8. SOUND BUTTON           |
| 3. NUMBER              | 9. DOUBLE QUANTITY BUTTON |
| 4. CHECK BUTTON        | 10. +30S BUTTON           |
| 5. PROGRAMME BUTTON    | 11. START BUTTON          |
| 6. STOP/CANCEL BUTTON. |                           |



## CHECKING THAT YOUR OVEN IS OPERATING CORRECTLY

The following simple procedure enables you to check that your oven is working correctly at all times.

First, place a bowl of water on the ceramic plate. Then close the door.

1. Select the power level by pressing the **Power Level** button once or more time.



2. Select the cooking time by pressing the **Number Buttons as required (Max:30min).**

Press **Start** button.

**Result** :The oven heats the water for 4 or 5 minutes. The water should then be boiling.

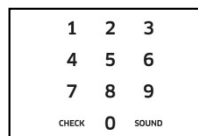

The oven must be plugged into an appropriate wall socket. The ceramic plate must be in position in the oven. If a power level other than the maximum is used, the water takes longer to boil.



### **Auto energy saving function.**

If you do not select any function when appliance is in the middle of setting or operating with temporary stop condition, function is canceled and the display will be turned off after 10 minutes.

Oven Lamp will be turned off after 5 minutes with door open condition.

## COOKING/REHEATING

The following procedure explains how to cook or reheat food.

**ALWAYS** check your cooking settings before leaving the oven unattended.

First, place the food in the centre of the ceramic plate. Then, close the door.

1. Select the power level by pressing the **Power Level** button once or more time.



2. Select the cooking time by pressing the **Number** buttons as required (Max:30mins).

**Result:** The oven light comes on.

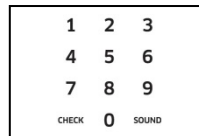

3. Press the **Start** button.

**Result:** Cooking starts. The oven beeps four times when cooking is over.

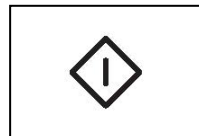

**Never** switch the microwave oven on when it is empty.

## **USING THE START AND +30 SEC BUTTON**

This button offers a convenient way to heat food in 30 seconds increments at the High power level.

1. Press the **+30s** button once for each 30sec. Press **Start** Button.

For example, press **+30s** button twice for one minute. The time will display, and press **Start** button.



2. Add Second to a program in progress by pressing the **+30s** button for each 30sec. you want to add.



## **USING THE STOP/CANCEL BUTTON**

The **Stop/Cancel** button allows you to clear instructions you have entered. It also allows you to pause the oven's cooking cycle, so that you can check the food.

1. To pause the oven during cooking, press **Stop/Cancel** button once.



2. To restart, press **Start** button.



 To correct a mistake you have just entered,press **Stop/Cancel** button once,then re-enter the instructions.

 To cancel cooking setting during cooking,press **Stop/Cancel** button twice.

## **SETTING COOKING TIME AND POWER LEVEL**

---

### **ONE STAGE COOKING**

You can stop cooking at any time to check the food.

1. Press the **Power Level** button to select the power.By pressing the **Power Level** button repeatedly,you can select the power level-HI,MED,or LO.



2. Use the **Number** buttons to enter the cooking time.You can set a time from one second to 30 minutes.  
To set a time over one minute,enter the second as well.  
For example,to set 10 minutes,enter **1,0,0,0**.

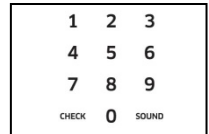

3. Press the **Start** button to begin cooking.

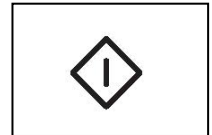

 The maximum allowable cooking time is 30mins.If the time exceeds 30 mins,the display will show "E3",then press **Stop/Cancel** button and repeat the steps.

### **MULTI-STAGE COOKING**

You can stop cooking at any time to check the food.

1. Press the **Power Level** button to select the Power. By pressing the **Power Level** button repeatedly, you can select the power level-HI, MED, or LO.



2. Use the **Number** buttons to enter the cooking time. You can set a time from one second to 30 minutes. To set a time over one minute, enter the second as well. For example, to set 10 minutes, enter **1,0,0,0**.

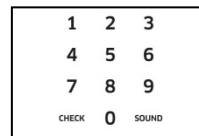

3. Repeat step 1 and 2 for II or III stage cooking.

4. Press the **Start** button to begin cooking.



## POWER LEVELS

You can choose among the power levels below.

Power Level	On(Sec)	Off (Sec)
HIGH(HI)(100%)	33	0
MEDIUM(MED)(70%)	23	10
LOW(LO)(50%)	16	17
DEFROST( 33%)	10	23



If you select higher power level, the cooking time must be decreased.



If you select lower power level, the cooking time must be increased.



The maximum allowable cooking time is 30 mins. If the time exceeds 30 mins, the display will show "E3", then press **Stop/Cancel** button and repeat the steps.

## USING RAPID DEFROST BUTTON

---

### DEFROST ONLY

The defrost time and power level are set automatically. You simply select the programme and the weight.

Use only dishes that are microwave-safe.

First, place the frozen food in the centre of the ceramic plate and close the door.

1. Press the **Rapid Defrost** button.



2. Press the **Number** buttons to set the defrosting time. You can set a time from one second to 30 minutes.

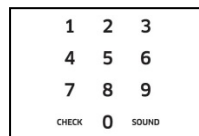

3. Press the **Start** button.



The maximum allowable cooking time is 30 mins. If the time exceeds 30 mins, the display will show "E3", then press **Stop/Cancel** button and repeat the steps.

## DEFROST COMBINE WITH MICROWAVE COOKING

1. Press the **Rapid Defrost** button.



2. Press the **Number** buttons to set the defrosting time. You can set a time from one second to 30 minutes.

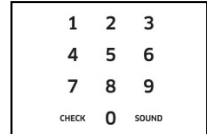

3. Press the **Power Level** button to select the cooking Power. By pressing the **Power Level** button repeatedly, you can select the power level-HI, MED, or LO.



4. Press the **Number** buttons to set the cooking time. You can set a time from one second to 30 minutes.

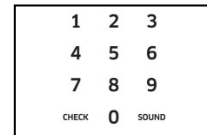

5. Repeat step 3 and 4 for II or III stage memory programming.

6. Press the **Start** button.



The maximum allowable cooking time is 30 mins. If the time exceeds 30 mins, the display will show "E3", then press **Stop/Cancel** button and repeat the steps.

## MEMORY PROGRAMMING

---

### ONE STAGE COOKING.

1. Upon pressing the **Program(PROG)** button, the oven will enter Program mode. The display will be cleared.



2. Using the **Number** buttons, enter the program Number from 1 to 20.

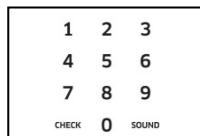

3. Then, press the Power Level button to select power. By pressing the **Power Level** button repeatedly, you can select the power level – HI, MED, or LOW.



4. Use the **Number** buttons to enter the cooking time. You can set a time from one second to 30 minutes. To set a time over one minute, enter the seconds as well. For example, to set 10 minutes, enter **1,0,0,0**.

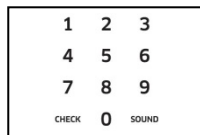

5. Pressing the **Program(PROG)** button to complete setting the memory. The display will show “:0”.



The maximum allowable cooking time is 30 mins. If the time exceeds 30 mins, the display will show “E3”, then press **Stop/Cancel** button and repeat the steps.

## MULTI-STAGE COOKING

1. Upon pressing the **program(PROG)** button, the oven will enter Program mode. The display will be cleared



- 
2. Using the **Number** buttons, enter the program number from 1 to 20.

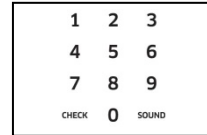

- 
3. Then, press the **Power Level** button to select power. By pressing **Power Level** button repeatedly, you can select the power level- HI, MED, or LOW.



- 
4. Use the **Number** buttons to enter the cooking time. You can set a time from one second to 30 minutes. To set a time over one minute, enter the seconds as well. For example, to set 10 minutes, enter **1,0,0,0**.

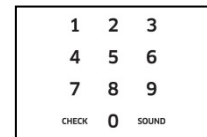

- 
5. Repeat step 3 and 4 for II or III stage memory programming.

- 
6. Pressing the **Program(PROG)** button to complete setting the memory. The display will show “:0”.



The maximum allowable cooking time is 30 mins. If the time exceeds 30 mins, the display will show “E3”, then press **Stop/Cancel** button and repeat the steps.



## USING MEMORY PROGRAMMING.

Press the **Number** buttons to select user-programmed memory functions (please refer to memory programming) from 1 to 20.

Press the **Start** button.



If TIME DEFROST include in STAGE COOKING, it works at first.



If you want to change program, just reset MEMORY PROGRAMMING.

## USING THE CHECK BUTTON

---

Confirming the cooking time and Power Level in each memory program.

1. Clear all operations by pressing the **Stop/Cancel** button.

Press the **Check(CHECK)** button to enter Check mode.



2. Using the **Number** buttons, enter the program number from 1 to 20.

For example, suppose you press '5', for the Memory Program 5 which is HI Power Level, I stage cooking with a time of 6 minutes and 30 seconds, 6:30.

First, '5' will be displayed, but will change to show the 6:30.

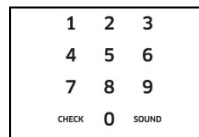

3. After one second, the display will clear automatically.

If you want to check other Memory Programs, just enter the Memory Program numbers.

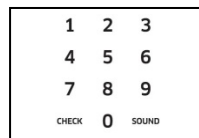

4. Press the **Stop/Cancel** button to exit the Check mode.



## Reading each Memory Program's Cycle Counter

1. Clear all operations by pressing the **Stop/ Cancel** button.  
Press the **Check** button to enter Check mode.



2. Press the **Start** button, and then press any **Number** button, from 1 to 20, and the number of cycles for that particular Memory Program will be displayed. The cycle count is displayed in units of 10.

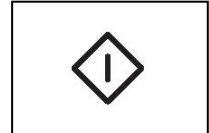

For example, if Memory Program 5 has been used 100 times, the display will show '10'.

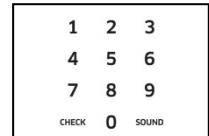

- As the display uses units of 10, the cycle counts are approximate. The cycle count displayed increases every ten cycles.
- For example, if the cycle count were 90-99, "9" would be displayed. The "9" would change to "10" on the 100<sup>th</sup> cycle. The cycle counter function has a limit of 99,999 cycles. Once that number is exceeded, the cycle counter will automatically clear and start again from "0".

3. After one second, the display will clear automatically. If you want to check other Memory Programs, just enter the Memory Program numbers.

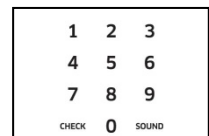

4. Press the **Stop/Cancel** button to exit the Checking mode.



## RESETTING THE MEMORY PROGRAM CYCLE COUNTER

---

1. Clear all operations by pressing the **Stop/ Cancel** button.  
The display will show ":0"



2. Hold the **Number '0'** and then press Rapid Defrost button.  
The microwave will emit a Beep sound confirming the reset operation.  
If you press clearing number, the display will show ':0'.



3. Press the **Stop/ Cancel** button to exit the Resetting mode.



## SETTING THE SOUND

---

1. Press the **Sound** button to adjust sound volume.  
The basic sound volume is "HI" and when you press the button repeatedly, the sound volume changes in the following order- LO, MED, HI, OFF one by one.



2. Press the **Start** button to exit **Sound** mode. The display will show ":0".



## USING THE DOUBLE QUANTITY BUTTON

---

1. Press the **Double Quantity(X2)** button.



2. By using the **Number** buttons, enter the **Memory Program** number from 1 to 20.

For example, suppose you press '5' button, for **Memory**

**Program 5** which is HI Power Level, I

Stage cooking with a time of 6 minutes and 30 seconds, 6:30



3. The **Memory Program** then Operates for double the user-programmed time, which in this case makes 13 minutes.



The maximum allowable cooking time is 30 mins. If doubling the programmed time exceeds the maximum allowable cooking time, the display will show "E3", then press **Stop/ Cancel** button.

## COOKWARE GUIDE

To cook food in the microwave oven, the microwaves must be able to penetrate the food, without being reflected or absorbed by the dish used.

Care must therefore be taken when choosing the cookware. If the cookware is marked microwave-safe, you do not need to worry. The following table lists various types of cookware and indicates whether and how they should be used in a microwave oven.

Cookware	Microwave-safe	Comments
<b>Aluminum foil</b>	√X	Can be used in small quantities to protect areas against overcooking. Arcing can occur if the foil is too much foil is used.
<b>China and earthenware</b>	√	Porcelain, pottey, glazed earthenware and bone china are usually suitable, unless deco-rated with a metal trim.
<b>Disposable polyester cardboard dishes</b>	√	Some frozen foods are packaged in these dishes.
<b>Fast-food packaging</b>		Can be used to ware food.Overheating may cause the polystyrene to melt
<ul style="list-style-type: none"> <li>● Polystyrene cups Containers</li> </ul>	√	
<ul style="list-style-type: none"> <li>● Paper bags or newspapare</li> </ul>	X	May catch fire.
<ul style="list-style-type: none"> <li>● Recycled paper of metal trims</li> </ul>	X	May cause arcing.
<b>Glassware</b>		Can be used, unless decorate with a metal trim.
<ul style="list-style-type: none"> <li>● Oven-to-tableware</li> </ul>	√	Can be used to warm foods or liquids.
<ul style="list-style-type: none"> <li>● Fine glassware</li> </ul>	√	Delicate glass may break or crack if heated suddenly.

<ul style="list-style-type: none"> <li>● Glass jars</li> </ul>	✓	Must remove the lid. Suitable for warming only.
<b>Metal</b> <ul style="list-style-type: none"> <li>● Dishes</li> <li>● Freezer bag twist ties</li> </ul>	X X	May cause arcing or fire.
<b>Paper</b> <ul style="list-style-type: none"> <li>● Plates, cups, napkins and Kitchen paper</li> <li>● Recycled paper</li> </ul>	✓ X	For short cooking times and warming. Also to absorb excess moisture.  May cause arcing
<b>Plastic</b> <ul style="list-style-type: none"> <li>● Containers</li> <li>● Cling film</li> <li>● Freezer bags</li> </ul>	✓ ✓ ✓X	Particularly if heat-resistant thermoplastic. Some other plastics may wrap or discolour at high temperatures. Do not use Melamine plastic  Can be used to retain moisture. Should not touch the food. Take care when removing the film as hot steam will escape.  Only if boilable or oven-proof. Should not be airtight. Prick with a fork, if necessary.
<b>Wax or grease-proof paper</b>		Can be used to retain moisture and prevent spattering.

- ✓ : Recommended
- ✓X : Use Caution
- X : Unsafe

## COOKING GUIDE

### Reheating Dish Entrees

Use the power levels and times in this table as a guide lines for reheating.

Food	Portion	Method	Power	Time (min)	Standing time(min)
Plated meal (chilled)	350 g	Plate a meal of 2-3 chilled components on a ceramic dish. Reheat covered.	MEDIUM	6½-7	3
Chicken curry& rice (chilled)	300 g	Plate a meal of 2 chilled components on a ceramic dish(g.g. rice and curry). Reheat covered.	MEDIUM	4½-5½	3
Pasta with sauce (chilled)	350 g	Put pasta(e.g. spaghetti or egg noodles) into a deep ceramic plate. Reheat covered. Stir during reheating.	HIGH	4-5	3
Filled pasta in sauce (chilled)	350 g	Put filled pasta(e.g. ravioli, tortellini) in a deep ceramic plate.Reheat covered. Stir occasionally during reheating.	MEDIUM	4½-5½	3
Lasagne (chilled)	400 g	Put the chilled lasagne (pre-cooked product) widthways in the centre of table. Reheat covered.	HIGH	4½-5½	3

Behamel potatoes (chilled)	400 g	Put bechamel potatoes (pr-cooked product) widthways in the centre of table. Reheat covered.	MEDIUM	5½-6½	3
Baked potatoes (ready cooked and chilled)	500 g	Pierce film and put potatoes on a flat ceramic plate.	HIGH	5-6	2-3

### **Reheating Soup and Stew**

Use the power levels and times in this table as guide lines for reheating.

<b>Food</b>	<b>Portion</b>	<b>Method</b>	<b>Power</b>	<b>Time (min)</b>	<b>Standing time(min)</b>
Soup (chilled)	250 g	Pour into a deep ceramic plate. Reheat covered. Stir during reheating.	HIGH	3-3½	2-3
Stew (chilled)	250 g 500 g	Pour into a deep ceramic plate or bowl. Reheat covered. Stir during reheating.	MEDIUM	4-4½ 5½-6	2-3
Bean stew (canned)	350 g	Pour into a deep ceramic plate or bowl. Reheat covered. Stir during reheating	MEDIUM	3½-4	2-3



Soup (frozen)	1000 g	Pour into a glass pyres dish with lid. Reheat covered. Stir during reheating.	HIGH	20-22	2-3
------------------	--------	---	------	-------	-----

### **Cooking Breakfast**

Use the power levels and times in this table as a guide lines for cooking.

<b>Food</b>	<b>Portion</b>	<b>Method</b>	<b>Power</b>	<b>Time (min)</b>	<b>Standing time(min)</b>
Bacon (chilled)	2 slices 20 g	Put bacon slices on kitchen paper on a flat ceramic plate.	HIGH	ca. 1½	1
Scrambled eggs	2 eggs	Beat eggs, add salt and 2 tsp.milk. Put in a deep ceramic plate. Stir several times during cooking	LO	ca. 2½	1
Baked beans (canned)	250 g	Put the beans in a deep ceramic plate. Reheat covered. Stir during reheating.	MEDIUM	2½-3½	1-2

### **Reheating Snacks**

Use the power levels and times in this table as guide lines for cooking.

<b>Food</b>	<b>Portion</b>	<b>Method</b>	<b>Power</b>	<b>Time (min)</b>	<b>Standing time(min)</b>
Cheeseburger (chilled)	150 g (1 pc)	Put burger on kitchen paper on a ceramic plate.	HIGH	1-1½	2-3
Cheeseburger (frozen)	150g (1 pcs)	Put burger on kitchen paper on a ceramic plate.	LO	3-3½	2-3

Hot dog (chilled)	125g (1 pcs)	Put hot dog on kitchen paper on a ceramic plate.	MEDIUM	1½	2-3
Pizza;slice (chilled)	100 g	Put the pizza slice on kitchen paper on a ceramic plate.	LO	1½-2	1-2
Meat& vegetable wrap (chilled)	200 g	Put the chilled wrap (filled pastry roll) on kitchen paper on a ceramic plate.	MEDIUM	2-2½	1-2
Quiche/pie (chilled)	150 g	Put quiche on kitchen paper on a ceramic plate.	MEDIUM	2-2½	2-3
Croissants	60 g (2 pcs)	Put the croissants on kitchen paper on a ceramic plate. Serve croissants directly after warming.	MEDIUM	½-1	-

### **Defrosting and Cooking Desserts**

Use the power levels and times in this table as a guide lines for cooking.

<b>Food</b>	<b>Portion</b>	<b>Method</b>	<b>Power</b>	<b>Time (min)</b>	<b>Standing time(min)</b>
Berries in sauce	250 g	Put frozen fruits in a glass pyrex bowl with lid. Reheat covered. Stir once during standign time.	MEDIUM	6-6½	2-3
Yeast dumplings with jam filling	300 g (2 pcs)	Put frozen yeast dumplings(pre-cooked) side by side in a glass	MEDIUM	4½-5	2-3

		pyrex bowl with lid. Moist the top of them with cold water. Cook covered			
--	--	---	--	--	--

### **Defrosting and Cooking Desserts**

Use the power levels and times in this table as a guide lines for cooking.

<b>Food</b>	<b>Portion</b>	<b>Method</b>	<b>Power</b>	<b>Time (min)</b>	<b>Standing time (min)</b>
Baguettes	150 g (1 pc)	Put the baguette widthways on kitchen paper in the oven.	DEFROST	ca.½	3-5
Bread rolls	50 g (4 pcs)	Put the rolls side by side on kitchen paper in the oven.	DEFROST	ca.3	3-5
Fruit cake	120 g (1 pc)	Put pieces of cake on a ceramic plate.	DEFROST	3-3½	5-10

## Troubleshooting

You may encounter a problem using the oven. In that case, first check the table below and try the suggestions. If a problem persists, or if any information code keeps appearing on the display, contact a local Samsung service centre.

### Checkpoints

If you encounter a problem with the oven, first check the table below and try the suggestions.

Problem	Cause	Action
General		
The buttons cannot be pressed properly.	Foreign matter may be caught between the buttons.	Remove the foreign matter and try again.
	For touch models: Moisture is on the exterior.	Wipe the moisture from exterior.
	Child lock is activated.	Deactivated Child lock.
The time is not displayed.	Power is not supplied.	Make sure power is supplied.
The oven doesn't work.	Power is not supplied.	Make sure power is supplied.
	The door is open.	Close the door and try again.
	The door open safety mechanisms are covered in foreign matter.	Remove the foreign matter and try again.
The oven stops while in operation.	The user has opened the door to turn food over.	After turning over the food, press the Start button again to start operation.

## Information codes

Code	Description	Action
E-3	Total cooking time setting over 30 mins.	Reset the microwave oven and try again, or plug out firstly and then plug in and try again.



If the above guidelines do not enable you to solve the problem, contact your local dealer or SAMSUNG after-sales services.

## **TECHNICAL SPECIFICATIONS**

SAMSUNG strives to improve its products at all times. Both the design specifications and these user instructions are thus subject to change without notice.

Model	CM1109
Power source	230-240V/50Hz
Power consumption Microwave	1500W
Output Power	1000W
Operating frequency	2450 MHz
Cooling method	Cooling fan motor
Dimensions(W x H x D) Outside	521X312X450
Oven cavity	364X212X335
Volume	25 Liter
Weight Net	17.7 kg
Gross	19.3 kg

Please be advised that the Samsung warranty does NOT cover service calls to explain product operation, correct improper installation, or perform normal cleaning or maintenance.

#### QUESTIONS OR COMMENTS?

COUNTRY	CALL	OR VISIT US ONLINE AT
AUSTRIA	0800-SAMSUNG (0800-7267864) [Only for Premium HA] 0800-366661 [Only for Dealers] 0810-112233	<a href="http://www.samsung.com/at/support">www.samsung.com/at/support</a>
BELGIUM	02-201-24-18	<a href="http://www.samsung.com/be/support(Dutch)">www.samsung.com/be/support(Dutch)</a> <a href="http://www.samsung.com/be_fr/support(Frech)">www.samsung.com/be_fr/support(Frech)</a>
DENMARK	70 70 19 70	<a href="http://www.samsung.com/dk/support">www.samsung.com/dk/support</a>
FINLAND	030-6227 515	<a href="http://www.samsung.com/fi/support">www.samsung.com/fi/support</a>
FRANCE	01 48 63 00 00	<a href="http://www.samsung.com/fr/support">www.samsung.com/fr/support</a>
GERMANY	0180 6 SAMSUNG bzw. 0180 6 7267864* (*0.2 /Anruf aus dem dt. Festnetz, aus dem Mobilfunk max 0.60 /Anruf)	<a href="http://www.samsung.com/de/support">www.samsung.com/de/support</a>
ITALIA	800-SAMSUNG (800.7267864)	<a href="http://www.samsung.com/it/support">www.samsung.com/it/support</a>
CYPRUS	8009 4000 only from landline, toll free	<a href="http://www.samsung.com/gr/support">www.samsung.com/gr/support</a>
GREECE	80111-SAMSUNG(80111 726 7864) only from land line (+30) 210 6897691 from mobile and land time	
LUXEMBURG	261 03 710	<a href="http://www.samsung.com/be_fr/support">www.samsung.com/be_fr/support</a>
NETHERLANDS	0900-SAMSUNG (0900-7267864)(0,10/Min)	<a href="http://www.samsung.com/nl/support">www.samsung.com/nl/support</a>
NORWAY	815 56480	<a href="http://www.samsung.com/no/support">www.samsung.com/no/support</a>
PORTUGAL	808 20 7267	<a href="http://www.samsung.com/pt/support">www.samsung.com/pt/support</a>
SPAIN	0034902172678	<a href="http://www.samsung.com/es/support">www.samsung.com/es/support</a>

SWEDEN	0771 726 7864(0771-SAMSUNG)	<a href="http://www.samsung.com/se/support">www.samsung.com/se/support</a>
SWITZERLAND	0800 726 78 64(0800-SAMSUNG)	<a href="http://www.samsung.com/ch/support(German)">www.samsung.com/ch/support(German)</a> <a href="http://www.samsung.com/ch_fr/support(French)">www.samsung.com/ch_fr/support(French)</a>
UK	0330 SAMSUNG(7267864)	<a href="http://www.samsung.com/uk/support">www.samsung.com/uk/support</a>
EIRE	0818717100	<a href="http://www.samsung.com/ie/support">www.samsung.com/ie/support</a>