



Heated Shelf Unit

Model: HSU-15300, HSU-15500



British Built for Purpose.





Welcome to Parry

Parry is one of the UK's foremost manufacturers of high-quality Stainless Steel Fabricated Products with a 40-year heritage rooted in British craftsmanship.

At Parry, quality and service are second nature. Striving to exceed our customers' expectations is not just our motto; it's the very heartbeat of our business. Our commitment to our customers is reflected in the **Parry 4E Standard Inspection Body** stating that all our products are:



Easy to use



Easy to maintain



Easy to clean



Easy to repair

Our ranges of Stainless Steel Products have been specifically designed with the consumer in mind and are tailored and compliant to your specific industry sector. All our products are 4E Compliant and meet EU & UK regulations, where applicable. The Parry brand stands for quality, reliability and value.

Our British designed products have been created by our expert in-house development team and manufactured to exacting standards using Industry specified grade of European stainless steel and holding relevant EU & UK certification for all product.

ISO9001 certification and continual investment in the training and development of our highly skilled, artisan workforce means that our clients have genuine peace of mind that they are buying hand crafted, quality products supported by five-star customer service. All Parry products meet EU regulations for their respective sector.

We are LEAN manufacturers, minimising waste, maximising productivity. We are proud to run an operation that is committed to minimising our impact on the environment.

Our equipment and furniture are manufactured in our 45,000 sq ft manufacturing facility in Draycott, Derbyshire in England's industrial heartland. Products are made to order if not available in our stocked items which means you can choose from 600 products, offering over 3,500 variants, with short lead times to suit your specific needs. That means you get exactly what you need when you need it.

Our product information can be found here, in our brochure or on our website www.parry.co.uk.

You have my personal commitment that Parry will exceed your expectations. Should you have any questions please contact your distributor. Alternatively, our customer services team will be happy to help you on **01332 875544**.

Mark Banton MBA
Managing Director



Contents

Contents.....	1
Product Overview	2
Safety Instructions	3
Installation Instructions	3
Operating Instructions	4
Cleaning Instructions	4
Maintenance Instructions.....	5
Fault Finding	5
Service Information.....	6
Wiring Diagram	7
Exploded View	8
Parts List	9
Warranty Information.....	10
Disposal & Recycling	11

**Parry Catering Equipment (Midlands) Ltd, Town End Road, Draycott, Derby, DE72 3PT.
Sales Tel: 01332 875544**







Product Overview

The heated shelf unit is design to assist food service outlets to keep cooked food warm prior to despatch to customers.

Each shelf can be independently controlled to different temperatures to suit customer's requirements.

It leads the industry in:

-  Design and aesthetic appeal
-  Performance
-  Power
-  Functionality
-  After sales support







	HSU-15300	HSU-15500
External Dimensions	1500mm (w) x 300mm (d) x 1580mm (Inset h)	1500mm (w) x 500mm (d) x 1580mm (Inset h)
Internal Dimensions	1265mm (w) x 285mm (d) x 300mm (h)	1265mm (w) x 485mm (d) x 300mm (h)
Number of shelves	5	5
Shelf Pitch	300mm	300mm
Total Power	2010W 230V 8.8A 50Hz ~	2510W 230V 11A 50Hz ~
Weight	62kgs	92kgs
Warranty	2 Years	2 Years



Safety Instructions



This appliance has been designed to warm products and therefore during its use parts of the appliance will become very hot. All personnel must be given sufficient supervision and training in the safe use of this appliance.

-  All appliances other than those fitted with a sealed moulded plug must be fitted with a sealed moulded plug must be fitted by a qualified electrician, in accordance with current regulations.
-  The unit should be installed in compliance with the Installation Instructions and the National regulations in force at the time. Particular attention should be paid to the Health and Safety at Work Act.
-  To prevent shocks, all appliances whether gas or electric, must be earthed.
-  To avoid scratching the highly polished exterior surface of this equipment whilst in transit, the protective film on the exterior surfaces has NOT been removed.
-  It is **IMPORTANT** that this protective film is peeled off before the equipment is used.
-  Ensure that vents intended to provide air flow in and around the unit are not obstructed.
-  Ensure the appliance is isolated from the power supply before installing, cleaning or maintaining the appliance.



Installation Instructions

- Remove all plastic coating from the metalwork prior to installation.

- Fix the wall fixing brackets to the rear of the unit using the screws and allen key provided.

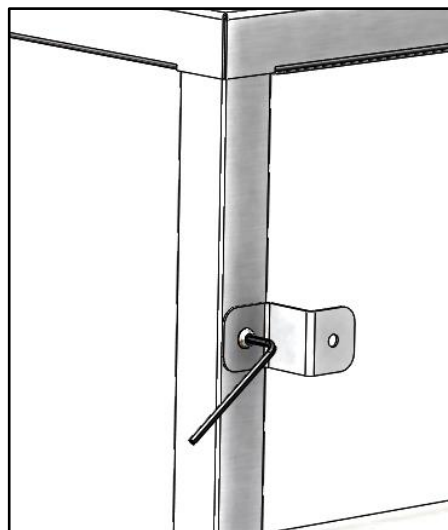

- Place the heated shelf unit in a safe suitable place ideally next to a wall to allow securing. ***Please be aware that the unit will become hot whilst in use and extra safety measures will need to be carried out.***

- Adjust the feet to ensure the unit is level.

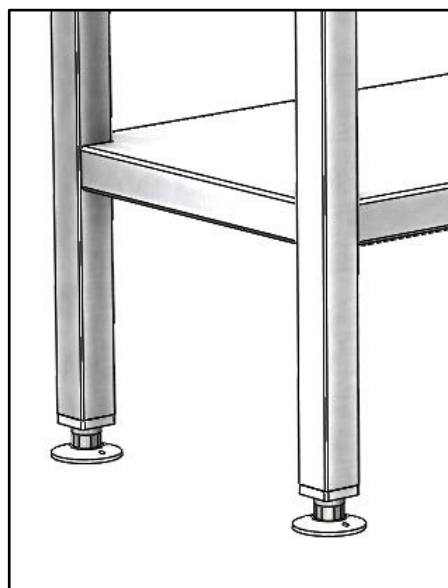

- Secure the unit against the wall using suitable fixing.

- Plug the unit into a 13amp socket.



Operating Instructions





The unit is designed to keep food warm whilst awaiting delivery / collection should never be used to try to cook food.

Please ensure that you use the correct packaging containers that can withstand the shelf temperatures, incorrect containers may melt and / or contaminate the food stuffs being held on the shelf.



- Turn on the power switch located at the side of controller. Each shelf is independently controlled by the switch and controller.
- The set point is factory set at 50°C this can be changed between 30 – 85°C

Setting the set point

- Press and hold the **set** button for at least 2 seconds to see the current set point.
- When in this mode the  symbol will appear on the controller display.
- Press using the down  and up  buttons to change the value.
- When the set press the **set** button for the value to be stored.
- Press the **M** button to exit the set point menu and return to actual temperature display and the  symbol will distinguish.





Please note that the display will fluctuate by a few degrees as the heating element turns on and off as it maintains the temperature.

Whilst heating the controller will show the  symbol on the display.



Cleaning Instructions

The appliance should be cleaned after every use.

-  Allow unit to cool down before cleaning
-  Turn off unit at the mains power.
-  Wipe down the machine with a soft cloth, do not use abrasive materials.
-  Stainless steel cleaners maybe used and cleaning instructions on the product must be adhered to.
-  Never clean the unit with water jets.



Maintenance Instructions

Ensure the appliance is isolated from the power supply before installing, cleaning or maintaining the appliance.

Maintenance and service must only be undertaken by a qualified electrician.



Parry Catering provides a complete after-sales service by offering the sales of spare parts directly to customers. Buying spares straight from the manufacturer allows customer to experience exceptional value and speedy delivery on all spare parts.

For more information on buying spares visit:

www.parry.co.uk/parry-commercial-catering-spares



Fault Finding

Fault	Check	Solution
Power switches not illuminating	Check that the unit is: -	Plugged in Turn on mains power. Check socket. Check fuse.
		See an engineer to replace faulty item.
Shelf not getting warm	Check controller is: -	Check that the controller power switch is on. Check that the set point is set correctly.
		Display not lit up - See an engineer to replace faulty item
Display shows A21 code	The display will alternate between A21 and "OPE" or "SHr" probe has become disconnected or failed.	See an engineer to replace faulty item



Service Information

This appliance should be routinely serviced to prolong its lifetime. Parry recommends that the appliance is serviced every 12 months by a Parry authorised engineer. Failure to service your product within the initial 12 month warranty period will cause the 24 month warranty to become void.

If the supply cord becomes damaged, it must be replaced by the manufacturer, it's service agent, or a similarly qualified person.

Enhanced 2 Years Warranty

Parry Catering (Midlands) Ltd offer an enhanced warranty of two years (including parts and labour) on all of the Parry manufactured products. To take advantage of this you should register your warranty by logging onto the company website and filling out our simple form.

www.parry.co.uk/the-parry-warranty

If you have any issues with your product and wish to request a warranty call you can contact our friendly team who will organize a Parry approved service engineer to attend and fix your problem.

All warranty requests can be sent to warranty@parry.co.uk alternatively call our warranty department for technical assistance on **01332 875544**





Wiring Diagram

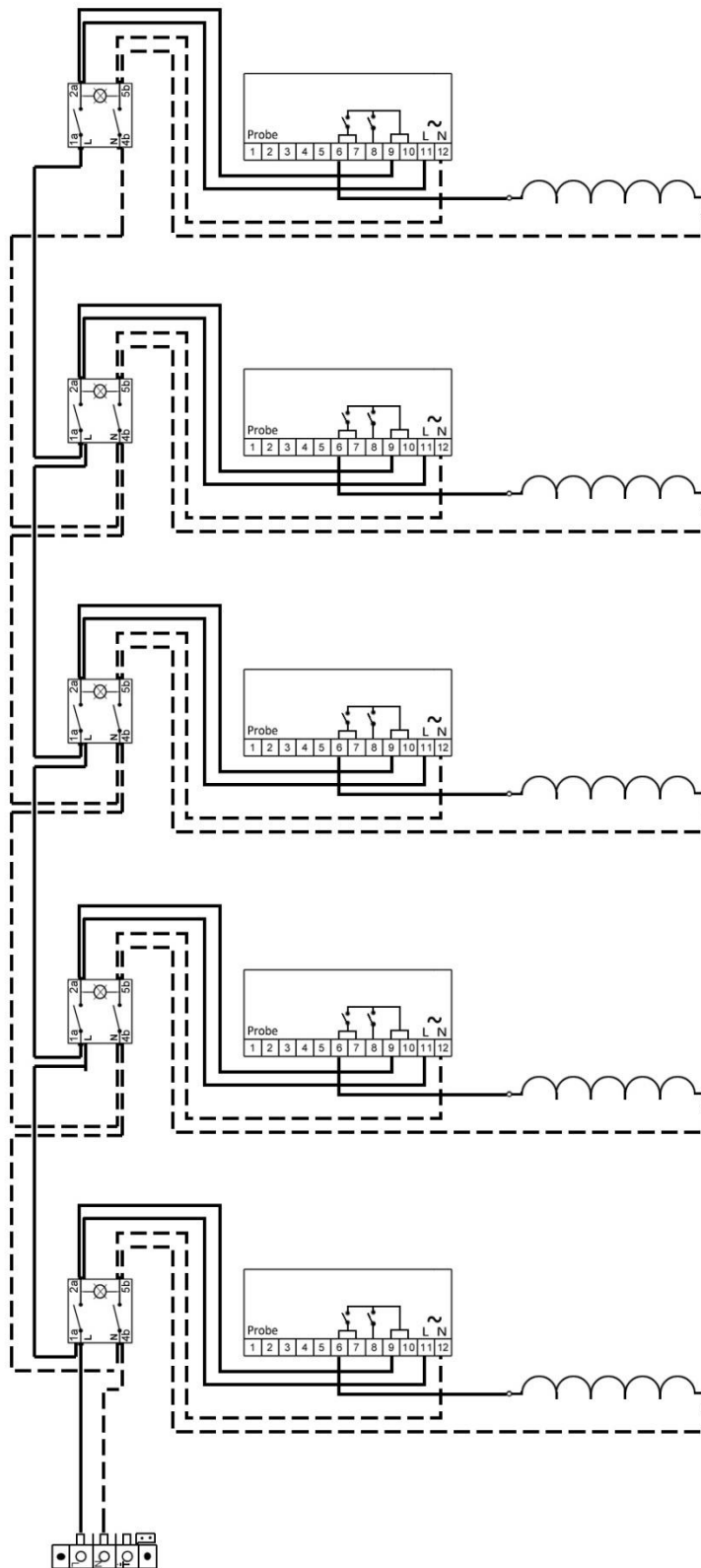

Probe wires are connected to connections 1 & 2 on the controller

Parry-Brand Built for Purpose



Exploded View

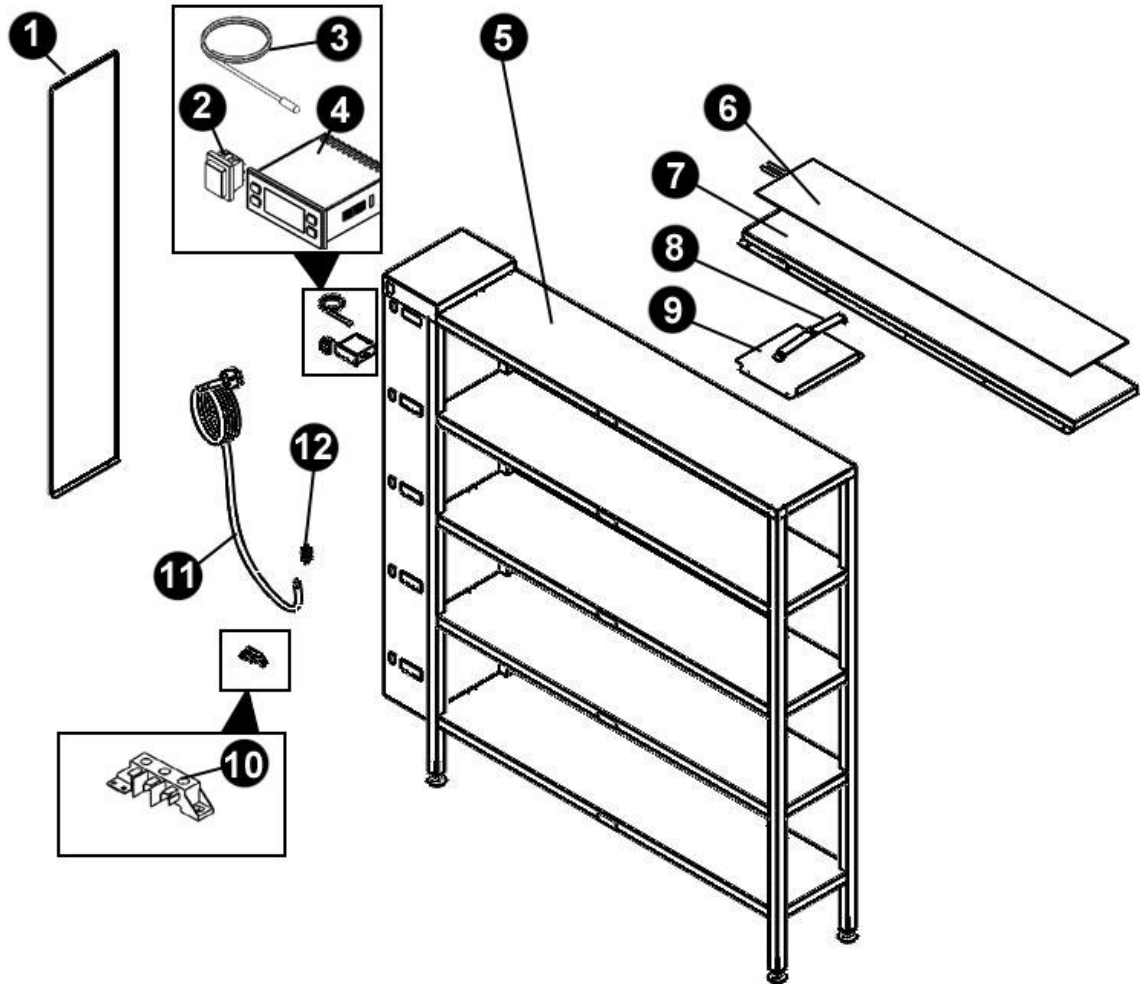



Parts List

Part Number	Description	Part Code
1	*Compartment Cover	No Code
2	Power Switch	SWRE000011
3	Probe	<i>Part of CONTROLLER8820</i>
4	Digital Controller	CONTROLLER8820
5	*Shelf Unit	No Code
6	Pad Element	ELPDHSU
7	*Aluminium Shield	No Code
8	*Probe Clamp	No Code
9	*Protective Guard	No Code
10	3 Way Terminal Block	TB3POLETB
11	Mains Lead	MLEAD25
12	Cable Gland	GLAND0M16
12a	Gland Nut	LOCKNTM16

*Metalwork Components



Warranty Information

The manufacturer's warranty is only valid in the UK mainland. Northern Ireland, Western Isles, Inner Hebrides and Islands are parts only warranty. Please be aware that the warranty starts from the date of purchase from Parry and not the sale or installation date of the equipment.

To be eligible for a 2 year warranty, products must be serviced at least once within the first 12 months of purchase.

All service calls will be carried out between 8am and 5pm, Monday to Friday.

Your warranty is invalid if your equipment has not been installed in accordance with the manufacturer's instructions. The misuse, alteration or unauthorised repairs of the equipment will also invalidate the warranty.

During the warranty period it is at Parry's discretion whether to repair or replace the equipment.

The warranty only applies if the equipment has been used in a professional manner following the manufacturer's instructions and maintenance guidelines.

The warranty covers defects in the material and component failure only. We are not liable for trading loss, loss of perishable items, water damage or loss due to injury or fire damage.

Please ensure you have referred to the manufacturer's instruction before placing a warranty call.

Contact our warranty department on **01332 875544** for technical assistance.











Please have your model number ready before calling.

All warranty requests must be submitted to warranty@parry.co.uk.

Failure to pay any warranty charges will result in your warranty being put on hold until the bill has been settled. Any issues regarding the raised charges should be put in writing to our warranty department for further investigation.

Register your product by visiting our website www.parry.co.uk

Not covered under warranty

-  Fault due to incorrect installation, poor maintenance or equipment abuse.
-  Resetting of equipment or circuit breakers.
-  Faulty electrics – e.g. customer's plug socket, plug, wiring, junction box fault, wrong fuse.
-  Products must be serviced within the first 12 months to be eligible for the 2 year warranty
-  Product not covered by warranty if combustible materials have been used, e.g. plastic trays.
-  Foil used on racks, blockages and lime scale issues.
-  Failure to grant access for pre-arranged service call.
-  Equipment that has been set up or used incorrectly e.g. dishwasher detergents, levelling and setting up of doors on a six burner cooker.
-  Excessive carbon build-up on griddle plates or overuse of lava rock on chargrills. (Recommended use by Parry no more than 2kg.)
-  All of the above points are not covered by warranty and any costs incurred, because of the above, will be forwarded to the parties responsible for placing the call.



Disposal & Recycling

This appliance is marked according to the European Directive 2002/96/EC on Waste Electrical and Electronic Equipment (WEEE).

By ensuring this product is disposed of correctly, you will help prevent potential negative consequences for the environment and human health which could otherwise be caused by inappropriate waste handling of this product.

A symbol on the product, or on the documents accompanying the product, indicates that

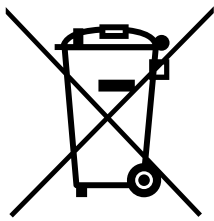

this appliance may not be treated as household waste. Instead it should be handed over to the applicable collection point for the recycling of electrical and electronic equipment.

Disposal must be carried out in accordance with local environmental regulations for waste disposal.





For more detailed information about treatment, recovery and recycling of this product, please contact your local city office, your household waste disposal service or the shop where you purchased the product.

Parry Catering recognises our obligations to the EU DIRECTIVE covering the waste disposal of electrical and electronic equipment (WEEE). Parry Catering are committed to this policy in order to help conserve the environment.

At the end of this unit's life you **MUST** dispose of it in an approved manner. You **MUST** not discard the unit or place it in the refuse bin.

You have several options:

-  Take the unit to an approved WEEE scheme company, there will be one in your area.
-  Take the unit to an approved waste disposal site; many sites are managed by your local authority.
-  Contact the units manufacturer, importer or their agent; the contact details will be on the unit.

There will probably be a charge for this service which will depend on the physical size and location of the unit. You will be given a collection price for a curb side collection based on commercial rates prevailing at the time.

It should be noted that the unit to be collected should be suitably packed and sealed to prevent dangerous gases and fluids from escaping. The condition of the unit must also be clean to comply with health and safety regulations.