

Excalibur[®]
NOURISH LIFE.



Dehydration Guide

www.drying123.com



Household Use Only





CONTENTS

<i>Introduction</i>	2
<i>Safeguards & Operating Instructions</i>	3
Temperature Guide	4
Timing	4
Cleaning	4
<i>Preparation</i>	5
Pretreatment	5
Dipping	5
Blanching	6
<i>Storage & Reconstitution</i>	7
Food Drying Guide – Fruits	8
Food Drying Guide – Vegetables	10
Leathers and Fruit Rolls	13
Fruit	13
Yogurt	13
Vegetables	13
<i>Jerky</i>	14
The Process	14
Dehydrating	14
Storage	14
<i>Beef, Game, Poultry, Fish Jerky</i>	15
<i>Raw & Living Foods</i>	16
What Are Living Foods	16
Food Temperature vs. Air Temperature	17
Enzymes and Temperature	17
How to use your dehydrator for Living Foods	17
<i>Other Dehydrator Uses</i>	18
Herbs and Spices	18
Nuts	18
Raising Bread	18
Pasta	18
“Stale” Foods	18
Yogurt	18
Cheese	19
Drying Photographs	19
Whole Meal Preparation	19
<i>Year-round Dehydration Tips</i>	20
<i>Recipes</i>	21
<i>Questions and Answers</i>	23
<i>Trouble Shooting Guide</i>	24
<i>Warranty Info</i>	26
<i>Helpful Hints & Tips</i>	28

INTRODUCTION

Working on a simple premise, the Excalibur® Dehydrator removes water from food by a continuous circulation of thermostatically-controlled warm air. A variety of foods, from bright golden kernels of farm-fresh corn to rings of island-sweetened pineapple can be dehydrated. Produce, however, is not the only food commonly preserved in a food dryer! Slices of beef, chicken, fish or even venison can be marinated in a combination of sauces and spices and easily transformed into homemade jerky. A carton of yogurt spread over a sheet of Paraflex™ or plastic wrap, dries, and becomes a vividly colored, taffy-like snack or fruit roll.

Operating cost for your Excalibur® Dehydrator is approximately 3 - 6 cents per hour. Using your dehydrator compared to traditional canning or freezing methods will prove to be well worth your initial low-cost investment.

SAFEGUARDS & OPERATING INSTRUCTIONS

IMPORTANT SAFEGUARDS

When using electrical appliances, these basic safety precautions should always be followed.

1. Read all instructions.
2. Do not touch hot surfaces.
3. To protect against electrical hazards do not immerse any part of the dehydrator, cord, or plug in water or other liquid.
4. Close supervision is necessary when any appliance is used near children.
5. Unplug from outlet when not in use and before cleaning. Allow to cool before putting on or taking off parts.
6. Do not operate any appliance with a damaged cord or plug or after the appliance malfunctions, or has been damaged in any manner. Return appliance to the nearest authorized service facility for examination, repair, or adjustment.
7. The use of accessory attachments not recommended by the appliance manufacturer may cause hazards.
8. Sharp utensils should not be used inside the dehydrator.

9.  **CAUTION HOT SURFACE: THE DEHYDRATOR DOES GET HOT TO THE TOUCH.**



10. Do not let cord hang over the edge of the table or counter, or touch hot surfaces.
11. Do not use outdoors.
12. Do not place on or near a hot gas or electric burner, or in a heated oven.
13. Always plug cord into the wall outlet before turning machine on. To disconnect, turn switch to "off" before removing plug from wall outlet.
14. Do not use appliance for other than intended use.
15. Do not remove the ground pin on your power cord.
16. Avoid contacting moving parts.
17. Clean only sides and bottom, don't wipe any electrical components.
18. This appliance should not be used by children or persons with reduced physical, sensory or mental capabilities or lack of experience and knowledge of using the appliance. Only persons who properly understand the safe use of the appliance the hazards involved shall use this appliance. Children should only operate the appliance under close supervision and in no case should they play with the appliance. Cleaning and user maintenance shall not be made by children without supervision.
19. This appliances is not intended to be operated with an external timer or separate remote control system.
20.  The symbol on the product or its packaging indicates that this product must not be disposed of with your other household waste. Instead, it is your responsibility to dispose of your waste equipment by handing it over to a designated collection point for recycling of waste, electrical and electronic equipment. The separate collection and recycling of your waste equipment at the time of disposal will help conserve natural resources and ensure that it is recycled in a manner that protects human health and the environment. For more information about where you can drop off your waste for recycling, please contact your local authority, or where you purchased your product
21. This appliance is not intended for use by persons (including children) with reduced physical, sensory or mental capabilities, or lack of experience and knowledge, unless they have been given supervision or instruction concerning use of the appliance by a person responsible for their safety. Children should be supervised to ensure that they do not play with the appliance.

SAVE THESE INSTRUCTIONS.

OPERATING INSTRUCTIONS

Operating your dehydrator is extremely simple! Begin by plugging in your unit. Then using both hands (to prevent tipping) carefully slide trays loaded with food into position. Once the trays are in place, replace door* and set the thermostat to the correct temperature.

1. Place the dehydrator on a smooth, dry surface.
2. Load the trays with food. Place the door on machine.*
3. Plug the power cord into standard 120 volt outlet or 220/240 volt outlet depending upon your voltage.
4. Set the thermostat to desired temperature.**
5. When the food has dehydrated, and is dry, allow it to cool. See pages 8 – 12 for proper dryness test and approximate drying time. Then package in airtight food storage containers.

**For door assembly, page 25.*

***TROUBLESHOOTING GUIDE, page 24.*



TEMPERATURE GUIDE

For your convenience, a colorful temperature guide has been affixed to your Excalibur® unit. Following this guide will ensure the use of proper temperatures when drying foods. If the heat is too high, the food may “case harden” which means it will feel dry on the outside; yet inside, it is still moist. If the heat is set too low, drying time and use of electricity is increased.



Timing

The individual foods listed on pages 8 - 12 is the approximate amount of time needed to dehydrate each food. Drying times, however, are enormously dependent upon multiple factors. These factors include the amount of humidity in the air, the moisture content of the food being dried and the method of preparation.

Humidity: Air must be kept in motion. Stagnant air will soon take on as much moisture as it can hold, and then drying will no longer take place. Drying must be a continuous process so the growth of micro-organisms is prevented. Check with your local weather service to determine the day's humidity level. The closer the humidity is to 100%, the longer it will take for your food to dry.

Moisture Content: The actual amount of water in the food you are drying is also a major consideration. Remember, water content of a fruit or vegetable can vary due to growing season, rainfall and environmental factors, as well as the ripeness of the food.

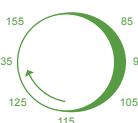
Slicing: Uniform slicing is the last factor contributing to the length of the drying cycle. Successful drying is only possible if the food you are drying is properly sliced, (not more than 1/4" thick) and spread evenly in a single layer on the drying trays, successful drying should be yours!

	<h3>Temperature</h3> <p>The thermostat range is 85° to 155° F.</p> <p>The 5 & 9 tray units without a timer have the on-off switch in the thermostat. Turn counter-clockwise for off.</p> <p>Turn thermostat clockwise to desired temperature setting.</p>
	<h3>Timer</h3> <p>On units with a 26 hour timer, the Timer is on the on-off switch.</p> <p>In order to select timed operation, turn knob to desired time setting. While timing, the knob will indicate remaining time.</p> <p>Consult the drying times pages 8-12 for timing information.</p>

Cleaning

Your machine is easy to clean, both inside and out. The interior food contact areas and exterior of your Excalibur Food Dehydrator should only be cleaned by wiping with a soft cloth or sponge dampened with warm water and a mild detergent. The dehydrator can then be rinsed using a soft cloth or sponge dampened with clear water. The trays can be cleaned by hand or simply by placing them in the top rack of the dishwasher. The tray's removable Poly screens can be cleaned by soaking them in warm soapy water and then wiping them down with a damp sponge. These inserts allow air to fully circulate around the food and the construction of the trays also prevents moisture from being trapped on the underside of the pieces. Therefore, the most even drying possible is attained. Re-usable non-stick sheets should only be wiped clean and NOT placed in the dishwasher. DO NOT USE harsh chemicals

or abrasive materials for cleaning. DO NOT immerse any portion of this appliance in water except the trays and poly screens.

Your dehydrator has been equipped with a removable door. This solid door prevents light from fading the colors or withdrawing nutrients from the food as it dries. Treat your door carefully to prevent it from getting scratched. To clean, use a damp sponge or soft cloth only.

PREPARATION

There is really no right or wrong way to prepare your food for drying. By following these few guidelines, success will be yours.

Pre-treatment

Pretreating food is not an essential procedure when using your Excalibur® Food Dehydrator. There are basically two types of pre-treatment, dipping and blanching. The fast drying times and controlled conditions under which your unit operates dries food before it has a chance to spoil. However, pretreating will help maintain:

- **Color:** reduces oxidation of foods such as apples and potatoes keeping them from turning a rust-like color.
- **Nutrients:** helps retain the minimal loss which tends to occur during the drying process.
- **Texture:** the chance for fiber deterioration in the produce is lessened.

There are basically two types of pre-treatment: dipping and blanching.

Dipping

Dipping is a treatment used primarily to prevent fruits or vegetables from oxidizing. The following are various pre-treatment dips with which you may want to experiment.

- **Sodium Bisulfite:** When mixed with water, sodium bisulfite is a liquid form of sulfur. It is the most effective and least expensive anti-oxidant. Use only a food-safe grade of sodium bisulfite that is made especially for dehydration. Sodium Bisulfite is available directly through Excalibur®.

If subject to sulfur allergic reactions, check with your physician before using Sodium Bisulfite as a dip.

- **Fruits:** Mix 1 1/2 tablespoons of Sodium Bisulfite in one gallon of water. Soak fruit slices for five minutes and halved fruit for fifteen minutes. Rinse.
- **Vegetables:** Recommended for steam blanching only. Add 1 teaspoon Sodium Bisulfite to each cup of steaming water and blanch as you would normally. This is particularly recommended for vegetables to be stored in excess of three months.



- **Ascorbic Acid-Citric Acid Dip:** is simply a form of vitamin C. Citric acid is found in all citrus fruits. These citrus type dips are available through Excalibur, in drug or health food stores in crystal, powder or tablet form. Soak the prepared produce in a solution of 2 tablespoons of powder to 1 quart of water for 2 minutes.
- **Fruit Juice Dip:** Citrus juices, such as pineapple, lemon or lime, may be used as a natural anti-oxidant. Stir 1 cup of juice into 1 quart of lukewarm water and soak for 10 minutes. Note: fruit juice is only 1/6 as effective as pure ascorbic acid and may add taste to your food.
- **Honey Dip:** Honey dips are used quite frequently on fruits to be dried. Many dried fruits sold in the grocery store or in health food stores have been treated this way. The honey will make fruit considerably sweeter and will add calories as well. Dissolve 1 cup of sugar in 3 cups of hot water. Allow mixture to cool until lukewarm, and add 1 cup honey. Dip fruits in small batches, remove with a slotted spoon and drain thoroughly before dehydrating.

When using a dip, follow the specific directions listed above. Then, drain the treated food and rinse it thoroughly. Blotting off any excess moisture with paper towels before placing the food in the dehydrator is the final important step. Excess moisture of foods will prolong the drying cycle.



Blanching

Blanching, as a means of pre-treatment, can be done either in boiling water or by steaming the foods. This pre-treatment is sometimes referred to as “checking” or “crazing.” You can use this method most effectively on tough-skinned fruits (sometimes having natural protective wax coating) such as grapes, plums, cranberries, etc. By boiling fruits in water for 1 to 2 minutes, the skin “cracks” and allows the moisture to more readily escape, thus the drying time is faster.

- **Water Blanch:** Fill a large pan over half-full with water. Bring the water to a boil and stir the food directly into the boiling water. Cover and blanch for approximately 3 minutes. Remove food from the boiling water and place it into ice water to cool. Blot with a towel to remove excess water before drying.
- **Steam Blanching:** Using an old fashioned, pan-type steamer, fill the lower portion with 2 inches of water. The perforated upper section is then filled with food. Let the water rapidly boil approximately four minutes. Remove food from the boiling water and place it into ice water to cool. Blot with a towel to remove excess water before drying.
- **Electric Steamers:** Electric steamers are perhaps the best means for blanching. The electric steamer will aid in the retention of nutrients, bring out the food's most vivid color and heighten the natural flavor of the produce. Follow the set guidelines provided in your electric steamer's operating manual for blanching individual fruits and vegetables.



STORAGE & RECONSTITUTION

Containers for dried foods should be safe from moisture and insects. Glass jars with tightly fitted lids, plastic zip-lock and vacuum/heat-sealable bags are recommended storage containers. Food-safe metal cans, such as coffee cans or cookie tins, may be used to store individual bags for extra protection.

Your dried foods should be stored in a cool, dark and dry area. The ideal temperature for food storage is 50° - 60°F/10° - 16°C. Storing foods in this manner further protects the flavors and colors of your dried products from fading.



Reconstitution

Dehydrated foods can easily be incorporated into your diet. Snacking on banana chips, dried seasoned meats and pieces of dried vegetables is a typical habit formed by many owners of Excalibur® Food Dehydrators. Reconstituting dried foods adds yet another dimension to the versatility of daily food preparation.

Properly dried foods rehydrate well. They return practically to their original size, form and appearance. If carefully handled, they will retain much of the aroma and flavor as well as their minerals and an appreciable amount of the vitamins. There are several methods of reconstituting dehydrated food, including soaking foods in water or juice, placing food in boiling water, cooking, or using an electric steamer. It is important to remember not to add salt, sugar or spices during the initial five minutes of reconstitution as these additives hinder the absorption process.

- **An Electric Steamer:** is one of the most efficient and successful means of rehydrating foods. The food is placed into the rice bowl, and covered with a liquid. The circulation of the steam will aid in permeating the food and plumping it back to its original, fresh state. For best rehydration results, follow the guidelines given in your electric steamer's operating manual.
- **Soaking:** place the pieces in a shallow pan, cover with the liquid, and allow 1 to 2 hours for the rehydration process to occur. If rehydrating overnight, place the pan in the refrigerator.
- **Boiling Water:** To reconstitute vegetables, place 1 cup of dried vegetables into 1 cup boiling water. Soak for 5 to 20 minutes. Prepare according to your recipe. To reconstitute fruits, place 1 cup of water and 1 cup dried fruit into a pan and simmer until tender.
- **Cooking:** For vegetable side dishes, fruit toppings or compotes, use 1 part liquid to 1 part dried food. For foods used in soufflés, pies and quick breads, add 2 parts of liquid to 3 parts dried food. When cooking fruits, place them into a saucepan with boiling water, turn heat to low and simmer 1 to 15 minutes or until tender.

The following charts are guidelines for the preparation, timing and testing of various fruits and vegetables. If the humidity level is low on the days you are drying, your drying times will be closer to the first amount of hours listed. If the humidity is high, it will be closer to the second amount of hours listed.

FOOD DRYING GUIDE FRUITS

Dry best at 135°F/57°C



Food	Preparation	Test	Time
Apples	Pare, core & cut into ¼” slices or rings. May be sprinkled with cinnamon if desired.	Pliable	7-15 hours
Apricots	Wash, cut in half, slice and remove pit. Push in backs dry skin side down.	Pliable	20-28 hours
Bananas	Peel & cut into 1/8” slices.	Leathery or Crisp	6-10 hours
Berries	Leave whole. For wax skin berries pretreat by crazing.	Leathery	10-15 hours
Cherries	Remove stems & pits. Cut in half & place skin side down & sticky on tray. Will be like raisins, watch to prevent over drying.	Leathery & Sticky	13-21 hours
Cranberries	Same process as berries.	Pliable	10-12 hours
Figs	Wash, cut out blemishes, quarter & spread one layer deep, skin side down.	Pliable	22-30 hours
Grapes	Wash, remove stems & cut in half or leave whole, skin side down. Blanching will reduce drying time by 50%.	Pliable	22-30 hours

*for raw & living foods - use 105°F/the drying time is extended



FOOD DRYING GUIDE FRUITS

Dry best at 135°F/57°C



Food	Preparation	Test	Time
Nectarines	Wash, pit and peel. Cut into 3/8" slices, dry skin side down.	Pliable	8-16 hours
Peaches	Wash, pit and peel-if desired 1/4" slices.	Pliable	8-16 hours
Pears	Wash, remove core, peel 1/4" slices, or 1/4 the pear.	Pliable	8-16 hours
Persimmons	Wash, remove cap & peel 1/4" slices.	Leathery	11-19 hours
Pineapple	Peel, remove fibrous eyes and core. Cut into 1/4" slices or wedges.	Pliable	10-18 hours
Prune Plums	Wash, cut in half, remove pit and pop the back to expose more surface to the air.	Leathery	8-16 hours
Rhubarb	Wash, cut into 1" lengths.	Leathery	6-10 hours
Strawberries	Wash, cut off caps, slice 1/4" thick.	Leathery & Sticky	7-15 hours
Watermelon	Cut off rind, cut into wedges and remove seeds.	Pliable & Sticky	8-10 hours



FOOD DRYING GUIDE VEGETABLES

Dry Best At 125°F/52°C



Food	Preparation	Test	Time
Asparagus	Wash & cut into 1" pieces.	Brittle	5-6 hours
Beans, Greens or Wax	Wash, remove ends, cut 1" pieces or French style.	Brittle	8-12 hours
Beets	Remove all but 1/2" of the top scrub thoroughly, steam until tender. Cool, peel & cut 1/4" slice or 1/8" cubes.	Leathery	8-12 hours
Broccoli	Wash & trim, cut stems into 1/4" pieces. Dry florets whole.	Brittle	10 -14 hours
Cabbage	Wash, trim & cut into 1/8" strips.	Brittle	7-11 hours
Carrots	Wash, trim tops, peel if desired. Cut into 1/8" cubes or circles.	Leathery	6-10 hours
Celery	Wash thoroughly, separate stalks, cut into 1/4" strips.	Leathery	3-10 hours
Corn	Shuck corn, trim silk & steam until milk is set. Cut off from cob & spread on tray, stirring several times while drying.	Brittle	6-10 hours
Cucumber	Wash, slice 1/8" thick.	Leathery	4-8 hours
Eggplant	Wash, peel, slice 1/4" thick.	Leathery	4-8 hours

*for raw & living foods - use 105°F/the drying time is extended

FOOD DRYING GUIDE VEGETABLES

Dry Best At 125°F/52°C



Food	Preparation	Test	Time
Greens	Wash thoroughly, trim, remove tough stems, spread over trays so leaves aren't matted together. For more even drying, stir several times.	Brittle	3-7 hours
Mushrooms	Brush off dirt or wipe with damp cloth, slice 3/8" slice from cap through stem ends. Spread in single layer on tray.	Leathery	3-7 hours
Okra	Wash, trim, slice 1/4" circles.	Leathery	4-8 hours
Onions	Remove root, top and skin, 1/4" slices, 1/8" rings or chop. Dry at 145°F/63°C.	Leathery	4-8 hours
Parsnips	Scrub, trim and peel if desired. Cut into 3/8" slices.	Tough/ Brittle	7-11 hours
Peas	Shell peas, wash and steam only until they indent, rinse with cold water, blot dry with paper towel.	Brittle	4-8 hours
Peppers	Remove stem, seeds and white section. Wash and pat dry, chop or cut 1/4" strips or rings.	Leathery	4-8 hours
Popcorn	Leave kernels on cob until well dried, then remove from cob and dry until shriveled.	Shriveled	4-8 hours
Potatoes	Use new potatoes, wash and steam for 4-6 minutes. Cut French style, in 1/4" slices, 1/8" circles or grate.	Brittle or Leathery	6-14 hours

FOOD DRYING GUIDE VEGETABLES

Dry Best At 125°F/52°C



Food	Preparation	Test	Time
Pumpkin	Cut into pieces, remove all seeds. Bake or steam until tender, scrape pulp from skin and puree in a blender. Pour onto Paraflex™ sheets or kitchen parchment paper. When dry cover with plastic wrap & roll.	Leathery	7-11 hours
Summer Squash	Wash, peel if desired, cut into 1/4" slices.	Leathery	10-14 hours
Tomatoes	Wash & remove stems, slice 1/4", Circles & for cherry/ grape tomatoes, slice in half, dry skin side down.	Leathery or Brittle	5-9 hours
Turnips	Peel & cut into 3/8" slices.	Brittle	8-12 hours
Winter Squash	Wash & cut into pieces, bake or steam until tender, puree pulp in blender, pour onto Paraflex™ drying sheets.	Brittle	7-11 hours
Yams	Wash, steam until just tender, peel and cut into 1/4" slices.	Brittle	7-11 hours
Zucchini	Wash & cut into 1/4" slices or into 1/8" slices for chips.	Brittle	7-11 hours



LEATHERS & FRUIT ROLLS

Leathers are an easy answer to the often heard request of “What is there to eat?” Yogurt, leftover fruits or vegetables can be pureed, sweetened and spiced and made into a nutritious, high-energy snack food. Spread the pureed, produce thinly on Paraflexx™ sheets or plastic wrap and dehydrate, transforming the liquid into a chewy, quick-energy snack! Leathers are so simple to make!

Select ripe or slightly overripe (but not spoiling) produce that blends and tastes well together. Strawberries and rhubarb, or bananas and pineapple make great combinations. Wash, remove any blemishes, stems or pits and peel produce if desired. Keep in mind produce skins are highly nutritious. Puree the produce in a blender until it is smooth.

Pour 1 1/2 to 2 cups of puree onto the Paraflexx™ or plastic wrap covered trays. Since the edges tend to dry more rapidly, the poured puree should be 1/8" thick at the center and 1/4" thick at the edges. Place the prepared puree in the dehydrator with the temperature set at 135°/57°C. Average drying time for leathers is 4-6 hours. When the leather has dried, it will be a bit shiny and non-sticky to the touch. Allow the leather to cool and peel it from the tray. Roll it into a tight cylindrical shape. A piece of plastic wrap, measured to fit the length and width, is then tightly wrapped around the leather.

Fruit

Tart fruits such as rhubarb and cranberries require sweetening before drying. To the fruit puree, add from 1/4 to 1/2 cup of honey or sugar. The amount of sweetener added is dependent on your personal preference. Apple leather can be flavored with ground cinnamon or nutmeg.

Peanut butter and banana leathers can be made with 4 ripe bananas and 1 cup old-fashioned peanut butter. Try adding coconut or chopped nuts to the leather for an even more interesting taste and texture! Be sure to refrigerate leathers containing nuts as the oil in them may shorten the leathers shelf life. Dry at 135°/57°C.

Yogurt

Yogurt when spread onto Paraflexx™ sheets or plastic wrap and dried becomes a vividly colored taffy-like snack. Make yogurt, add flavoring such as pureed strawberries or peppermint extract. For best results with commercially made yogurt, use pre-stirred yogurt. Cut the rolled yogurt leathers into 1/2" pieces and re-dry the individual “bites” for 1 hour. Re-drying the yogurt after it has been cut will help seal the edges and prevent the pieces from sticking in the storage container.

Vegetables

Vegetables can be steamed until tender, pureed and mixed with herbs and spices. Tomato puree mixed with Italian herbs can be dried and later rehydrated for use as tomato paste or sauce. Gazpacho leathers made from tomato, cucumber, onion, green pepper and herbs is a delicious, low calorie treat! Carrot leathers can be the base for a cream soup. Using your imagination, experiment a bit to find out what you will like the most! Dry at 125°F/52°C.



JERKY

Many recipes are available, but it's fun to make up your own concoction. You can use virtually any combination of the following ingredients: soy, Worcestershire, tomato or barbecue sauce; garlic, onion or curry powder, seasoned salt or pepper.

Pick a lean cut of raw meat as free from fat as possible; the higher the fat content, the shorter the storage life of the jerky. The best way to get uniform pieces is with a meat slicer, but a sharp knife will do. When using a knife, partially freezing raw meat will make slicing easier. Slice the meat either with or across the grain. Jerky cut with the grain will be chewy; cut across the grain will be very tender but more brittle. Cut into strips 1' wide, 3/18" thick and as long as you want. Once sliced, cut off all visible fat.

To better preserve your jerky, apply either dry or brine cure prior to dehydrating. Dry cures are salt and seasoning mixtures rubbed into the meat surfaces. Brine cures or marinades combine water with the salt and seasoning. Meat is soaked in the brine until the salt is absorbed.

The Process

To dry cure, spread the meat strips in a single layer on a cutting board or some other flat surface. Sprinkle the curing mixture on both sides of the strips. Coat the strips evenly. Layer the strips one on top of another in a glass, plastic, or stoneware container that is sealed tightly.

Meat for brine curing should be layered with the cure pored over it to cover the top layers. Place the container in the refrigerator and marinate for 6-12 hours (or preferably overnight.) Turn the strips over several times to ensure thorough coating.

Dehydrating

Shake off any excess cure and spread the meat strips in a single layer on the dehydrator trays. Dry at 155°F/68°C for approximately 4-6 hours, occasionally blotting off any fat droplets that appear on the surface. While drying, the temperature will go up and down around the set point - this is important to dry correctly. Your meat will hit 160° if you use the 155°-set point on the dial.

Always test jerky using a cooled piece. Properly dried jerky, when bent, should crack but not break.

Storage

Package cooled jerky in air-tight containers such as zip-top or vacuum sealed bags. For best flavor retention, package the jerky into individual serving sizes and store in a cool, dark, dry place. If beads of moisture form on the inside of the storage container, the jerky is not dry enough and could mold - dry longer.



Beef Jerky

Flank, round and sirloin tip cuts are the best to use when making beef jerky. Rich in protein, beef is also high in phosphorus, iron, and riboflavin. See page 19, whole meal prep.

Game Jerky

Deer, bear and elk meat can all be made into jerky. Venison makes excellent jerky because it has no marbled fat. Flank or round cuts are best for this purpose. Before drying, game meat should be frozen for 60 days at 0°F/-18°C. This should kill any disease causing bacteria that may be present. To prepare, follow instructions for beef jerky.

Poultry Jerky

For something uniquely different, try cooked chicken or turkey jerky. For this kind of jerky, you can use the same cures as you would for meat. Since poultry is very fibrous, expect your jerky to be somewhat more brittle than its beef counterpart. Dry at 155°F/68°C until dehydrated throughout (about 4 hours.)

Fish Jerky

Dehydrating fish is not a process to treat lightly. Fish for jerky must be extremely fresh to prevent spoilage before it can be dried. Be on the lookout for the oil content of the fish. Fatty or oily fish, like tuna, spoil rapidly and, unlike meat, there is no way to simply cut off the fat. Dehydrating these types of fish is inadvisable (see chart below.)

- **Curing:** Make up a cold brine consisting of 3/4 cups salt to 1 1/2 quart water and place the fish in it to marinate for about 1/2 hour. Rinse the fish thoroughly to remove traces of salt; then arrange the pieces on a cutting board. Coat the fish with a dry cure which may be made up of any combination of salt and seasonings. Layer the coated fish in an airtight glass or plastic container. Refrigerate for 6-10 hours.

Remove the fish from the refrigerator and shake off any excess cure. Lay the strips on the dehydrator trays so none are touching, and dry for approximately 12-14 hours at 155°F/68°C.

- **Testing:** When you squeeze the fleshy part of a cooled piece of fish between your thumb and forefinger, it should never be crumbly or crunchy. Finish by smelling and tasting the fish. The jerky should have a mildly fishy flavor and aroma. Fish jerky should contain 15% to 20% water and there should be no visible surface moisture.
- **Storage:** Store according to beef jerky storing instructions.

Fish/Shellfish	% Fat	Fish/Shellfish	% Fat
Catfish*	5.2	Rockfish	0.2
Cod	0.5	Salmon*	9.3
Croaker	2.5	Sea Bass	1.6
Flounder	1.4	Sea Herring	2.8
Greenland Turbot	3.5	Sea Trout	3.8
Grouper	1.0	Shark*	5.2
Haddock	0.5	Shrimp	1.6
Halibut	4.3	Smelt	2.0
Lake Trout*	11.1	Snapper	1.1
Mackerel*	9.9	Sole	1.4
Monkfish	1.5	Tuna*	5.1
Mullet*	6.0	Whitefish*	7.2
Ocean Perch	1.4	Whiting	1.3
Pollock	1.3	Yellow Perch	1.1
Rainbow Trout*	6.8		

RAW & LIVING FOODS

In 1963 Dr. Ann Wigmore and Victoras Kulvinskas founded the Hippocrates Health Institute in Boston, MA where they taught their patients about the benefits of a completely raw, organic diet. Today this raw food lifestyle has evolved into a worldwide movement, with Ann and Victoras being recognized as the movement's mother and father.

What are Living Foods?

Ann Wigmore Foundation: "Living foods or raw foods are uncooked, free from animal products, organic, easy to digest, rich in enzymes, and highly nutritious. They include home grown sprouted grains and beans, vegetables, fruits, nuts, fermented preparations, dehydrated snacks and delicious deserts such as fruit and nut pies and fruit ice cream."

As you bite into a raw fruit or vegetable, you are experiencing the full potential of vitamins, minerals, and enzymes in one compact package. There is no nutritional loss caused by the heat of cooking, nor loss of water-soluble vitamins and minerals. If your produce was organically grown, it is free of chemicals, color dyes or preservatives.

One of the most important characteristics of raw foods, is they are easier for your body to digest than cooked food. The enzymes are what make raw foods easier to digest than cooked foods. When food is cooked the enzymes become deactivated by heat. During the digestive process, the natural food enzymes assist your body's digestive enzymes in breaking down food into digestive proteins. By eating more raw foods, your body does not have to work as hard to digest the foods, which gives your body more vibrant energy in other areas, making you feel stronger, healthier and happier.

Dehydration is the best way to preserve the essence of raw fruits and vegetables. Dehydrating does not subject foods to the high temperatures associated with cooking, or traditional canning methods. When raw food is heated to an internal food temperature of 118°F/48°C or higher, for an extended period of time, its nutritional values begin to deteriorate, especially enzymes. Canning also leaches out water-soluble vitamins and minerals, which also depletes the healthy qualities of the raw-living foods.

Why Excalibur® is Superior for Living Foods

There are two important elements when dehydrating living foods to preserve the enzymes. The first element is the proper control of temperature, and the second, is the time it takes the food to dehydrate. If the temperature is too high the enzymes can be destroyed, but if the temperature is too low, the food takes longer to dry, causing it to spoil or grow bacteria.

With the Parallexx™ Horizontal-Airflow Drying System and an adjustable thermostat, Excalibur® Dehydrators are uniquely suited for dehydrating raw foods while retaining the highest food qualities. The adjustable thermostat allows you to control the air temperature, and the rear-mounted fan that creates the Parallexx™ Horizontal-Airflow Drying System provides fast and even drying. With these two features, Excalibur® Dehydrators are able to keep the food temperature low enough to preserve the enzymes while raising the air temperature high enough to dry the food quickly, preventing mold and bacteria from growing. Most stackable dehydrators are poorly designed with no temperature control, or fan to properly circulate the air, and they dry from the bottom up requiring frequent rotating of the trays.



Excalibur® adjustable thermostat has been specifically designed to create a proper fluctuation in the air temperature. As the air temperature fluctuates up, it quickly evaporates moisture from the surface of the food. Then as air temperature fluctuates down, moisture from the center of the food moves to the dryer outer surface. This proper fluctuation in temperature also helps to keep the food temperature very constant throughout the entire dehydrating cycle.

Food Temperature vs. Air Temperature

During the dehydration process the food temperature is generally 20 to 30 degrees F cooler than the air temperature, due to the effects of evaporation. As the warm air blows across the food, moisture is evaporated from the foods surface, creating a cooling effect that keeps the food temperature cooler than the air temperature. Keep in mind that the dial settings represent air temperature, so the air temperature may be as much as 25 degrees higher.

Enzymes and Temperature

There are many varying opinions among raw foodists concerning the temperature at which enzymes become deactivated. The most frequently quoted temperature is 118°F/47°C / (food temperature) based upon the studies of Dr. Edward Howell. However, he also states that the optimal temperatures for enzymes are between 45°/7°C and 140°F/60°C, and temperatures above 140°F/60°C will destroy all enzymes. We have discovered through research and testing, that the second of these two statements is more accurate when dehydrating, and that enzymes can actually withstand food temperatures into the 140°F/60°C. According to Dr. John Whitaker, a world recognized enzymologist, and emeritus professor and Dean of the Food Science and Nutrition department at UC Davis in California; most enzymes do not become deactivated until they reach between 140°F/60 °C and 158°F/70°C. This supports Howell's statement of 140°F/60°C, as well as our tests and scientific experiments. We have tested food samples for enzymatic activity that were dried at temperatures up to 145°F/63°C and found it to be the same as in the foods dried at lower temperatures.

Enzymes are also most susceptible to damage by high heat while the food is wet. Once a high percentage of the foods moisture has been removed, the enzymes become more stable or dormant, and can withstand food temperatures higher than 155°F/68°C, according to Viktoras Kulvinskis. When the food is rehydrated with water or in the digestive track the enzymes become active again and assist your body's enzymes in the digestive process.

How to use your Dehydrator for Living Foods

According to Ann Wigmore and Viktoras Kulvinskis, the best way to preserve the living enzymes, and overcome the potential of spoilage or bacteria growth, is to set the dehydrator on the highest temperature setting for the first two or three hours, then turn it down to less than 120°F/49°C for the remaining time. During the initial hours the food temperature will not exceed 118°F/47°C because of the high moisture content in the food. Neither will the air temperature immediately rise to 145°F/63 °C. It may take several hours to get up that high. Following this procedure will cut the lengthy (30+ hours) drying time in half. If you cannot be there to turn the dehydrator down you may set at a lower temperature between 105°F/41°C and 120°F/49°C, but keep in mind that the lower the setting, the longer it will take to dehydrate.



OTHER DEHYDRATOR USES

Herbs and Spices

Herbs and spices are sometimes a neglected part of our cookery. Use your Excalibur® dehydrator to dry your own freshly grown herbs! Buy bulk quantities of fresh herbs and spices, dry them and create special teas and seasonings. Left-over parsley will no longer be wasted...as drying herbs and spices require rather simple preparation:

1. Trim off any dead or discolored plant parts. Wash the leaves and stems in cool water. Blot with towel to remove as much water as possible.
2. Preheat dehydrator with the thermostat on 95°F/35°C - 115°F/46°C.
Note: If herbs take longer than 4 hours, turn the temperature to a higher setting. Higher humidity areas may require temperature as high as 125°F/52°C to dry herbs and spices properly.
3. Spread the plants in a single layer on trays.
4. Dry 2 to 4 hours. This time can vary greatly.
5. Store in airtight containers free from moisture. Also, keep dried herbs and spices from sunlight. Sunlight fades the color and weakens flavoring oils.

Nuts

Nuts provide a concentrated source of protein, and many are rich in necessary dietary fats as well. Nuts can be dried at home in their natural state or spiced and seasoned.

1. Whole, unshelled nuts or just the kernels or nutmeats can be dried.
2. Spread nuts in a single layer on the drying trays.
3. Dry at 115°F/46°C - 125°F/52°C. Whole nuts should dry in 10 to 14 hours, and nut meats should be dry in 8 to 12 hours.
4. Store in airtight containers in the refrigerator.

Note: Due to high oil content, nut meats may turn rancid if not refrigerated.

Raising Bread

The perfect environment for raising bread exists right inside your dehydrator. Remove the trays from the dehydrator, set the thermostat at 115°F/46°C and allow the unit to preheat. Place a shallow pan of water on the bottom of the dehydrator. Insert a tray directly above the water and place the bowl of dough on the tray. Cover the dough with a cloth to keep it from drying out. Allow the dough 1/2 to one hour of time to rise. When it has risen, continue with preparation according to your recipe.

Pasta

No need for separate pasta racks! Place strips of freshly made pasta in single layers onto your drying trays. Dry for 2 to 4 hours at 135°F/57°C. Store in airtight packages.

Recrisping

There is no need to throw away crackers, chips, cookies or cereals that have become stale. Re crisp these items by placing them in a single layer on the drying trays and drying them for 1 hour at 145°/63°C.

Yogurt

Homemade yogurt is economical and easy when made in your dehydrator. Add 1 cup powdered milk to 1/2 gallon low-fat milk. Scald for 2 seconds. Remove from heat and cool to 115°F/46°C. Add 2 tablespoons of non-pasteurized plain yogurt to the cooled milk. Pour

into containers and cover. Incubate in the dehydrator at 115°F/46°C for 5 hours. (*Note: Use a candy thermometer for best results.*) Do not disturb, bump, open door or move while yogurt is incubating. When finished, refrigerate. Before serving, add flavors or fresh fruit, if desired.

Cheese

Cottage cheese got its name from the fact it is so easily made in the home...or in the cottage. Unripened cheese, such as cottage cheese, can be made in your Excalibur® dehydrator. To make this cheese, you'll need a gallon of pasteurized milk and either 4 tablespoons of unflavored yogurt, 1/2 cup fresh buttermilk, or 1/4 tablet of rennet dissolved in 1/2 cup warm water.

Pour the milk into a crock and warm it to room temperature, about 72°F/22°C. Mix in the yogurt, buttermilk, or rennet and cover the crock with cheesecloth. Place the crock in the dehydrator and hold the temperature inside at 85°F/29°C and 12 to 18 hours until clabbered. Clabbering means that the milk has separated to form thick, solid "curd" and the watery, liquid "whey." When the milk has thickened into curds and little whey lays on the surface, the cheese is clabbered.

Next, cut the curd as follows. Use a long bladed knife and make all cuts approximately 1/2" apart.

1. Holding the knife vertically, make straight up and down cuts across the curd.
2. Now slant the knife and make diagonal slices down through the cheese following the cuts of step 1, make the first cut at a 45° angle but gradually straighten the blade so that the last cut is nearly vertical.
3. Repeat the process in step 2, only slant the knife in the opposite direction.
4. Turn the crock 180°F/82°C and make a final set of vertical cuts to form a crosshatch pattern on the surface. This process helps the sour whey drain out.

Place several inches of water in a large pan, set the crock in it and heat to 115°F/46°C. Hold the cottage cheese at this temperature for 1/2 hour, stirring occasionally. Once the time is up, line a colander with cheesecloth and pour in the curds and whey. Allow the whey to drain off; otherwise, it will give the cottage cheese a bitter taste. To get rid of even more of the sour taste, dip the colander in cold water and gently stir the curds to wash away the last traces of the whey. Let the curds drain thoroughly. If desired, add 1 teaspoon salt per pound of cottage cheese and 4-6 tablespoons of cream. After refrigeration, your cottage cheese will be ready to eat as is or in fruit salads, dips, cheesecake and casseroles.

In addition to using your dehydrator to make soft cheeses, semi-soft and hard cheeses also can be made. There are between 700 and 2000 kinds of cheese and instructions for making them would become a book in itself! Preserve it, Naturally! has "how-to's" for making semi-soft and hard cheeses in your Excalibur® dehydrator.

Drying Photographs

To dry photographs, treat and wash as usual. Shake or squeegee off the excess liquid and place on the drying trays. Dry until no wet spots remain. *Note: Dry only photographs that have been printed on resin-water stock. Other types will wrinkle unless pressed flat.*

Whole Meal Preparation

Outdoor enthusiasts will want to use the dehydrator to prepare whole meals that need only to be rehydrated. Dried meats combined with powdered tomato and dried vegetable bits can be mixed with dried pasta and cooked in a kettle over the campfire for a "gourmet" after-hiking dinner! A bit of creativity and knowledge of required rehydration time is all that is needed to devise recipes for lightweight and nutritious take-along meals.

YEAR-ROUND DEHYDRATION TIPS

January

Good Buys: Avocados, Bananas, Cabbage, Cauliflower, Mushrooms, Pears, Potatoes, Turnips and Winter Squash.

February

Good Buys: Avocados, Bananas, Broccoli, Cabbage, Cauliflower, Kumquats, Mangos, Mushrooms, Pears, Tangerines, Winter Squash.

March

Good Buys: Artichokes, Asparagus, Avocados, Bananas, Broccoli, Grapefruit, Kumquats, Lettuce, Mushrooms, Radishes, Spinach.

April

Good Buys: Asparagus, Bananas, Cabbage, Chicory, Escarole, Onions, Pineapple, Radishes, Rhubarb, Spinach, Strawberries.

May

Good Buys: Asparagus, Bananas, Celery, Papaya, Peas, Pineapple, Potatoes, Strawberries, Tomatoes, Watercress.

June

Good Buys: Avocados, Apricots, Bananas, Cantaloupe, Cherries, Corn, Cucumber, Figs, Green Beans, Limes, Mangos, Nectarines, Onions, Peaches, Peas, Peppers, Pineapple, Plums, Summer Squash.

July

Good Buys: Apricots, Bananas, Blueberries, Cabbage, Cantaloupe, Cherries, Corn, Cucumbers, Dill, Eggplant, Figs, Gravenstein, Apples, Green Beans, Nectarines, Okra, Peaches, Peppers, Prunes, Watermelon.

August

Good Buys: Apples, Bananas, Beets, Berries, Cabbage, Carrots, Corn, Cucumbers, Dill, Eggplant, Figs, Melons, Nectarines, Peaches, Pears, Peppers, Plums, Potatoes, Summer Squash, Tomatoes.

September

Good Buys: Apples, Bananas, Broccoli, Carrots, Cauliflower, Corn, Cucumbers, Dill, Figs, Grapes, Greens, Melons, Okra, Onions, Pears, Peppers, Potatoes, Summer Squash, Tomatoes, Yams.

October

Good Buys: Apples, Bananas, Broccoli, Grapes, Peppers, Persimmons, Pumpkin, Yams.

November

Good Buys: Apples, Bananas, Broccoli, Cabbage, Cauliflower, Cranberries, Dates, Eggplant, Mushrooms, Pumpkin, Sweet Potatoes.

December

Good Buys: Apples, Avocados, Bananas, Grapefruit, Lemon, Limes, Mushrooms, Oranges, Pears, Pineapple, Tangerines.

RECIPES

Banana Blush Leather

- 1 cup strawberries
- 1 banana

Puree fruit in blender. Pour onto Paraflexx™ sheets or plastic wrap and dehydrate at 135°F/57°C until leathery.

Peachy Pear Leather

- 1 cup peaches, peeled
- 1/2 cup pears, peeled

Blend together and sweeten if desire. Pour onto Paraflexx™ sheets or plastic wrap and dehydrate at 135°F/57°C until leathery.

Persimmon-pineapple Leather

- 1 cup persimmon pulp
- 1/2 cup crushed pineapple

Puree in blender. Spread onto Paraflexx™ sheets or plastic wrap and dehydrate at 135°F/57°C until leathery.

Spaghetti Sauce Mix

- | | |
|-------------------------------|---------------------------------|
| 1 tbsp dried onions | 1 tbsp dried parsley |
| 3 tsp cornstarch | 1 tbsp dried green peppers |
| 1 1/2 tsp dried garlic powder | 1 tsp sugar |
| 1/2 tsp dried oregano | 1/2 tsp dried basil |
| 1 cup tomato powder | 1/4 cup dried, sliced mushrooms |

Mix all ingredients and store in a tightly sealed glass container. To prepare sauce, add 3 cups of water to mix and simmer until thick. Serves 4.

Beef Jerky Ole'

- | | |
|------------------------------------|-------------------------------|
| 1 jar of mild salsa | 1 package chili seasoning mix |
| 1 tsp oregano powder | crushed red pepper |
| 5 lbs lean beef, sliced 1/4" thick | |

Remove all visible fat from beef. Combine all ingredients except crushed red pepper in a large bowl. Place meat into a zip-top plastic bag and add marinade. Place in refrigerator overnight, turning occasionally.

Place piece of meat in a single layer on the drying trays. For extra zest sprinkle crushed red pepper sparingly over the meat.

Dehydrate meat for 6-10 hours at 155°F/68°C. Test for dryness; when meat is bent, it should crack, but not break. Store in air-tight container or vacuum sealed bags.

Visit www.drying123.com for more recipes and to submit your own.

Creamy Mushroom Soup

1 1/2 cups dried mushrooms	1/2 cup dried onions
2 cups hot beef bouillon	1/4 cup margarine
4 cups milk	1 tsp salt
6 tbsp flour	parsley or garnish

Saute mushrooms and onions in margarine in a heavy saucepan for 5 minutes, stirring occasionally. Combine bouillon, milk, salt & flour. Blend until smooth. Add to sautéed mushrooms and onions. Cook over low heat until the mixture comes to a boil, stirring constantly. Garnish with parsley. Makes about 8 servings.

Sweetheart Yogurt Leather

Strawberry, cherry or raspberry pre-stirred yogurt	Paraflexx™ sheets
Heart shaped cookie cutter	

Cover each drying tray to be used with a Paraflexx™ sheet or plastic wrap. Use 1 carton of yogurt per tray. With yogurt at room temperature, empty cartons onto sheets. With a spatula, smooth the yogurt into an 8-10" circle. Dry at 135°F/57°C for 4-5 hours. When dried, yogurt will be shiny and non-sticky when lightly touched. With a heart shaped cookie cutter, cut 4-5 hearts out of the cooled piece of yogurt. Cover each with plastic wrap and store.

Potatoes O'Brien

2 cups dried, chopped potatoes	1/4 cup dried onion
Fresh ground black pepper to taste	1/2 cup crumbled bacon (optional)
1/4 cup chopped dried green onion	1/4 cup dried red peppers
4 tbsp oil	salt to taste

Rehydrate potatoes, onion & pepper, letting stand about 20 minutes, drain. In a skillet, over medium heat add oil. Cook potatoes, onion & pepper until crisp & golden brown. Add crumbled bacon, salt, & pepper. Serves 6 – 1/2 cup serving each.

Summer Salad Topping

3/4 cup dried onion flakes	1/2 cup dried crumbled carrots
1/4 cup dried red peppers	1/4 cup dried green peppers
1/4 cup dried parsley	1/4 cup sunflower seeds
1/2 cup dried tomato flakes	1/2 cup grated parmesan cheese

Coarsely chop all ingredients in a blender. Be sure that all ingredients are thoroughly mixed. Refrigerate mixture in glass jar with tight lid. To serve, sprinkle mixture over salads.

Aztec Corn

3/4 cup dried onion	1 1/2 cup dried corn, rehydrated
1 cup sour cream	1/4 cup mild red salsa
1/4 teaspoon pepper	3 tablespoons butter
1/4 cup water	1 cup shredded Monterey Jack cheese
3/4 teaspoon salt	1 can chopped black olives

Saute onion in butter until soft. Add corn & water. Cover tightly & cook over medium heat for 5 minutes. Remove cover and over high heat, boil away most of the liquid. Stir in sour cream, cheese, salsa, olives, salt & pepper. Heat thoroughly, but do not boil. Serves 6

QUESTIONS & ANSWERS

One side of my drying trays seems to be dried before the other.

What should I do?

Because your dehydrator may dry one side faster than the other, halfway through the drying cycle you may want to turn the trays 180°. This will speed up the dehydration process and will reduce energy consumption.

My apples and pears have darkened to a rusty-brown color while drying.

Are they safe to eat?

Yes. Fruits that have turned brownish color are safe to eat. Many fruits will oxidize during the drying process. Oxidation happens when the flesh of the fruit is exposed to air. By pretreating fruits oxidation is reduced.

Why should the edges of my fruit leather be thicker than the center?

With fruit leathers, the edges of the mixture tend to dry first. If the edges are the same thickness as the center, they will dry too quickly and become brittle.

My fruit leathers are very thin and brittle. I'd like to make them like the ones sold commercially. How can I do that?

Juicy fresh fruits, such as strawberries, can be too runny to create a thick, chewy leather like the commercial types. By simply adding a banana when pureeing, the mixture will become thick and the fruit leather will as well. Be sure to pour 3/4 to 1 cup of puree on each tray and allow it to spread out. Remember, the poured puree should be 1/4" thick at the edges.

If I powdered my dried vegetables, what could I use them for?

Powdered onion and garlic, of course, are favorite seasonings for meats and sauces. Powdered tomatoes can be reconstituted into tomato sauce, paste, catsup, juice or soup. Powders are easy to make. A blender or food processor will give you the finest texture. Simply place pieces of dried vegetables into a blender and process. Store in air-tight bottles or jars.

As items dry, should they be removed to allow better circulation for still moist foods and avoid over drying?

Yes. As foods dry, remove them from the trays and package. The other still moist pieces should remain in the dehydrator until they are completely dry. However, if you have sliced your food into uniform pieces and have turned your trays 180° halfway through the cycle, your load should be finished at the same time.

*Do you have more detailed information in your book *Preserve It, Naturally!* Does it include guidelines or is it just recipes?*

Preserve It, Naturally! over 250 page book. It contains hundreds of color pictures and diagrams! The book completely details every aspect of drying from mint leaves to pistachio nuts. It has detailed directions for craft ideas, instructions for yogurt and cheese making, dehydrating grains and even making baby food! There are 275 recipes using home dried fruits, vegetables, meats and grains for you to try, experiment with or use as a guideline while concocting your own!

TROUBLE SHOOTING GUIDE

All Excalibur® Dehydrators are checked three times for any electrical or mechanical problems. They are shipped in perfect working order. If you see any damage to the machine due to rough shipping you must report it to the shipper or dealer you purchased from. Excalibur® will not be responsible for damage due to shipping. Technical support may be contacted at (800) 875-4254 or (916)381-4254 from 8am-5pm Mon-Fri Pacific Standard Time.

Problem	Answer
Nothing turns ON	Test the outlet with another appliance that works. Test the dehydrator on another outlet that you know has power.
Fan makes a rubbing noise	Due to rough shipping the trays may have been forced into the fan's protective screen. Take out the trays, and blow on the fan blade to locate where it is rubbing against the screen. You may need to turn the fan on and press gently against the screen and listen where the noise increases. With a pair of needle nose pliers pull the screen away from the fan blade at point of contact.
No heat, but fan works	Remove trays and check for any loose wires. There may be a piece of dust or shipping debris blocking the tiny electrical points in the thermostat, or it may simply be stuck due to rough shipping. With the fan running, turn the knob back and forth between the highest and lowest settings pausing for a moment on each setting. Repeat for 40 knob rotations. Then with the fan turning, stop the rotation of the fan by pressing against the metal mesh screen towards the fan blade until it stops. This will make a loud noise - this is OK. Use your flattened hand - never place any object through the square holes in the screen. With the fan blade stopped look for glowing, if you see glowing, immediately let go of the screen, you have cleared the points and your unit is fixed. If there is no glowing you must replace the fuse. Fuses are available on-line.
Polyscreens missing	The polyscreens are all placed on the bottom or top tray. Take out all the trays and look inside the dehydrator with sufficient light so you can see them. They are there.
Accessories are missing	Kitchen accessories are shipped in the dehydrator box with exception of larger items like the apple peeler, v-slicer, jerky gun or cannon. They are placed on the side of the dehydrator and may have slid underneath. Double check by removing all packaging. Paraflexx™ sheets are the same color as the corrugated box, so look closely.
Door seems to be broken or scratched at bottom	Most high-quality plastic parts are injection molded. A mold is put into a plastic injection-molding machine, where the plastic is melted and injected under extremely high pressure into the mold. Where the plastic enters the mold is called the gate. All plastic parts must have a gate. Most gates are in an area that is not seen. The best place for the gate on the door was the center on the bottom. We break the gate off and if necessary file off any sharp edges. Due to design constraints this is the best we can do.

EXCALIBUR'S® CONVENIENT LIFT-OFF DOOR

Medium 5 Tray and Large 9 Tray Models

To install the door hold it at a slight angle, (see Fig. 1). Place the hooks on the inside top of the door on the ledge at top of dehydrator, (see View A). Be sure there is an even space between the door and the side of dehydrator, (see Fig. 2), and that the bottom of the door does not hit the sides, (see front and side View B). This allows moist air to exit.

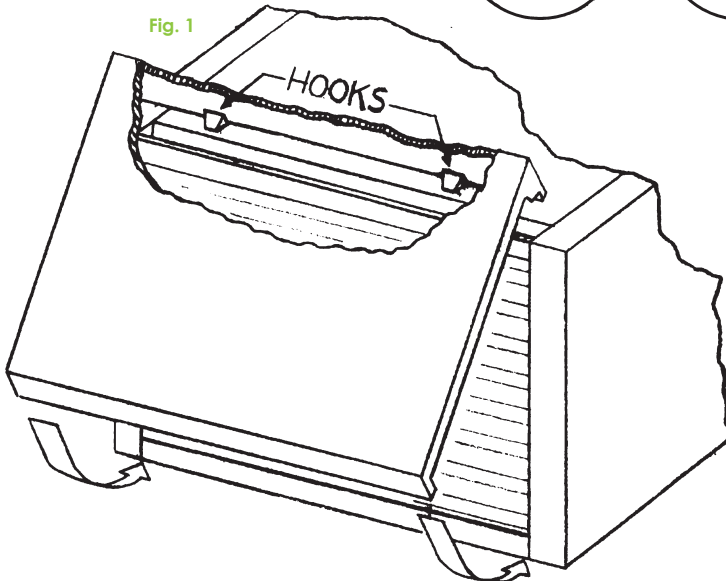
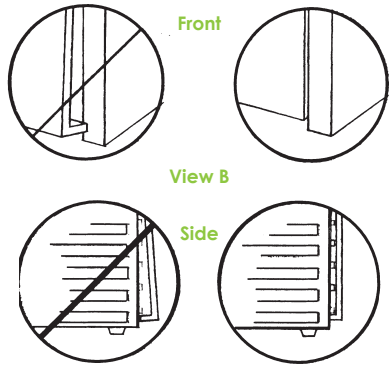
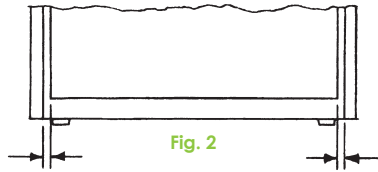
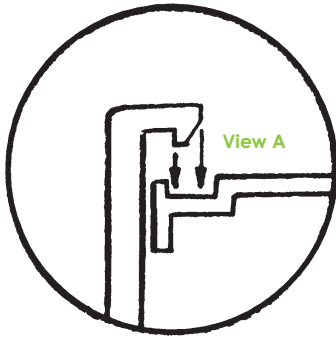

DOMESTIC 5 YEAR LIMITED WARRANTY

HOME UNITS

Excalibur Dehydrators are built to a such a high standard they come with a 5 year limited warranty. Since we manufacture the EXCALIBUR® here in the U.S.A., we have replacement parts on hand, if a component of your dehydrator is accidentally damaged or needs warranty repair. Our 5 year limited warranty covers all plastic and electrical components for one year free of charge. For the balance of five years new or rebuilt replacements for factory defective electrical parts will be supplied at no charge. Shipping of the electrical parts are the responsibility of the customer.

We recommend that you properly register your purchase by completing the warranty registration online.

FACTORY-DIRECT EXCLUSIVE

Domestic 10 Year Extended Warranty - Home Units

This warranty is available on Food Dehydrators purchased directly from EXCALIBUR®. We warranty your EXCALIBUR® Food Dehydrator to be free of defects in workmanship or materials for ten years. This warranty covers all plastic and electrical components for one year free of charge. For the balance of 10 years new or rebuilt replacements for factory defective electrical parts will be supplied at no charge, all you have to do is pay the shipping to get the parts to you. You can have peace of mind knowing your investment will be taken care of if the need arises.

International 1 Year Warranty- Parts Only

If you have warranty questions, please contact Excalibur® Customer Service at (800) 875-4254 or (916) 381-4254 from 8am-5pm Mon-Fri Pacific Standard Time.



HELPFUL HINTS & TIPS

- **Cut all your items the same thickness.** If you don't, they'll dry at different times. A slicer is helpful.
- **Do small or Large batches.** If you are doing a small batch, put the remaining empty trays in the dehydrator. Your dehydrator is designed to work with all or none of the trays.
- **Purchase the *Preserve It Naturally Book!*** This book covers everything you need to know about dehydration and how to make the most of your dehydrator.
- **Experiment with your drying times.** Everyone's tastes are different. You may like some food dried longer for a crispier texture. You may like other dried less for a chewier texture. Be sure to write down the food and times so you remember what you like!
- **Store your Paraflexx® sheets in the bottom of the dehydrator.** This is a great way to protect your sheets when you're not using them. They can also double as a drip liner at the bottom of your dehydrator for easy cleaning.
- **Cleaning tips for Paraflexx® sheets.** DO NOT SOAK your Paraflexx® sheets. This will damage them. Simply wipe down with a warm, soapy cloth. Then again with clean water. That's it.
- **Register your warranty online:** <http://www.drying123.com>
- **Not sure your foods are dry enough?** Put some of your foods in an air-tight bag and check it in a few minutes – if you see water droplets in the bag then you need to dry the food more. Some small fogging is normal as the food cools off.







Excalibur®

NOURISH LIFE.



Excalibur®

6083 Power Inn Road, CA 95824

1.877.368.2797 • www.drying123.com



Find us on Facebook

www.facebook.com/ExcaliburDehydrators

Household Use Only