

Lincat

Installation, Operating, Servicing and Conversion Instructions

Opus 800 Gas Boiling Tops
OG8003-A002, OG8004-A002
& OG8009-A002

Please make a note of your product details for future use:

Date Purchased: _____

Model Number: _____

Serial Number: _____

Dealer: _____

Opus **800**

CONTENTS

Important Information	2
Warnings and Precautions	3
Technical Data	3
Conversion	4
Installation and Commissioning	6
Operating Instructions	7
Servicing, Maintenance and Component Replacement	8
Fault Finding	10
Spare Parts List	11
Service Information and Guarantee	12

IMPORTANT INFORMATION



Read these instructions carefully before using this product, paying particular attention to all sections that carry warning symbols, caution symbols and notices. Ensure that these are understood at all times.



WARNING!

This symbol is used whenever there is a risk of personal injury.



CAUTION!

This symbol is used whenever there is a risk of damaging your Lincat product.

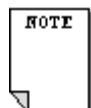

NOTE:

This symbol is used to provide additional information, hints and tips.

KEEP THIS MANUAL FOR FUTURE REFERENCE

WARNINGS AND PRECAUTIONS



This appliance must be installed, commissioned, serviced and converted by a qualified person in accordance with national and local regulations in force in the country of installation.

During operation parts may become hot - avoid accidental contact.

Parts protected by the manufacturer shall not be adjusted by the user.

Do not obstruct or block the flue.

Disconnect this appliance before servicing, maintenance or cleaning.

TECHNICAL DATA

Model	OG8003	OG8004	OG8009
Dimensions			
Height (mm)	450		
Width (mm)	600	900	300
Depth (mm)	800		
Weight (kg)	56	81.2	31.4
Hob Cooking Surface w x d (mm)	600 x 600	900 x 600	300 x 600
Heat Input (Gross)			
Total - Natural	30.0kW	45.0kW	15.0kW
Total - Propane	27.2kW	40.8kW	13.6kW
Hob Burner - Natural	7.5kW		
Hob Burner - Propane	6.8kW		
Hob Low	2.0kW		
Connection and Operating Pressures			
Gas Inlet Connection	½" BSP (Rp ½)	¾" BSP (Rp ¾)	½" BSP (Rp ½)
Supply Pressure – Natural G20 I _{2H}	20mbar		
Supply Pressure – Propane G31 I _{3P}	37mbar		
Gas Consumption			
Total - Natural	2.86 m ³ h ⁻¹	4.29 m ³ h ⁻¹	1.43 m ³ h ⁻¹
Total - Propane	1.94 kg h ⁻¹	2.92 kg h ⁻¹	0.97 kg h ⁻¹
Hob – Natural	0.71 m ³ h ⁻¹		
Hob – Propane	0.49 kg h ⁻¹		

CONVERSION

Conversion of Gas Type – Injector Changes

Model	Gas	Inlet Pressure	Injector	i	Mark	Part No.
OG8003	G20	20 mbar	GG	1.96	196	JE273 x 4
OG8004	G20	20 mbar	GG	1.96	196	JE273 x 6
OG8009	G20	20 mbar	GG	1.96	196	JE273 x 2
OG8003	G31	37 mbar	GG	1.25	125	JE274 x 4
OG8004	G31	37 mbar	GG	1.25	125	JE274 x 6
OG8009	G31	37 mbar	GG	1.25	125	JE274 x 2

Hob Valve Low Rate Screw

- Adjust low rate screw **J** for each of the hob burners, so that at low rate the burner stays lit.

Hob Tap Components	
Part	Description
G	Manifold
H	Gas tap
J	Low rate screw
K	Clamp screw

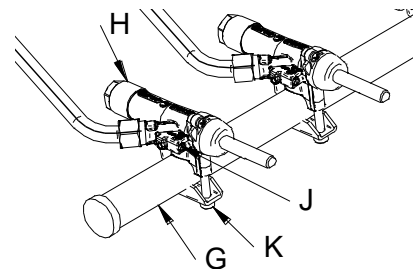

Fig. 6

Hob Burner Injectors

- Remove pan supports **AA** and covers.
- Lift off the burner cap **NN** together with the burner body **MM**.
- Remove injector **GG** and fit replacement applicable to the required gas type.
- Replace burner base **MM** and cap **NN**.
- Repeat the procedure for remaining hob burners.

Hob Burner Components	
Part	Description
FF	Injector Housing
GG	Injector
HH	Grub Screw
JJ	Retaining Screw
KK	Venturi Assembly
LL	Gasket
MM	Burner Body
NN	Burner Cap
PP	Retaining nut

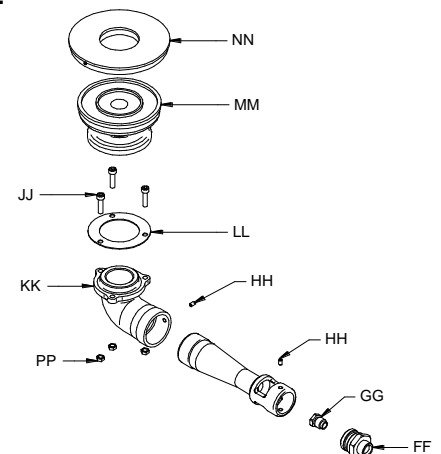

Fig. 7

Completion of Conversion

- ◁ Remove the redundant data plate and gas type identification label and attach new replacements, corresponding to new gas type.
- ◁ Test all previously dismantled joints for soundness.
- ◁ Functionally operate the appliance to the new operating pressure as detailed in page 4.

INSTALLATION AND COMMISSIONING

Site this appliance beneath an extraction canopy for the removal of combustion products.

When making the gas connection, fit an isolating cock into the supply line close to the appliance for emergency shutdown or servicing purposes.



Installation must include sufficient ventilation to prevent the occurrence of unacceptable concentrations of substances harmful to health in the room of installation. There must be a minimum free area of 4.5cm² per kW of total heat input.

Allow for a sufficient flow of fresh air for complete gas combustion.

Do not connect directly to any flue, ducting or mechanical extraction system.

The gas supply hose or tubing shall comply with national requirements in force and shall be periodically examined and replaced as necessary.



An equipotential bonding terminal is provided to allow cross bonding with other equipment.

Install this appliance on a level surface ensuring all vents are unobstructed.

Any partitions, walls or furniture must be of non-combustible material.

Minimum distances = A, 50mm B, 1000mm – see Fig 1.

If this appliance is fitted with castors, use caution at all times when manipulating or moving, and lock castors when appliance is in position.

GAS SUPPLY AND CONNECTION

The gas inlet connection is at the rear of the appliance. The pipe work should be of adequate size but not smaller than the gas inlet connection at the rear of the appliance, i.e. Rp ½" BSP (OG8003), ½" BSP (OG8004) & Rp ¾" BSP (OG8002).

The gas supply tubing or hose shall comply with national requirements in force and shall be periodically inspected and replaced as necessary.

All joints made must be leak free.

Final gas connection to the appliance and gas supply shall comply with local regulations.

When making the connection to the appliance an isolating cock should be fitted into the supply line close to the unit, for emergency shutdown or servicing purposes.

SUPPLY PRESSURES

The appliance is connected directly to the gas supply where the gas supply pressure is controlled at the source of inlet in the building or via the governor attached to the bottle gases. See Technical Data for the supply pressures.

- < To gain access to the gas pressure test nipple the fascia panel requires removal (see page 8). The test nipple is situated in the centre of the manifold rail.
- < Remove the blanking screw and attach a pressure gauge to the boss of the test nipple.
- < Light the oven burner and set thermostat to the highest setting and check the pressure.

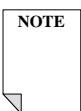

For Propane with a 50mbar supply pressure a governor is required for adjustment to 37mbar.

OPERATING INSTRUCTIONS

This appliance is only for professional use and should only be used by qualified personnel.

Ensure that the person responsible understands how to light, safely operate, clean and shut down the appliance and is made aware of the position and operation of the gas isolating cock in the event of an emergency.

Ensure that all controls have free and easy movement, if not contact a qualified service engineer.

This appliance is intended to be used for pan frying or boiling.

All users should know how to clean burner caps and to correctly locate the burner cap on the burner body.

LIGHTING SEQUENCE – HOB BURNER

- < Open the main gas cock.
- < Push in the control knob then rotate anti-clockwise to any position to allow gas through to the burner. Manually light this burner using a taper or piezo ignitor wand.
- < On establishing a flame at the burner, keep the knob depressed for approximately 15 seconds then release. The burner should remain lit.

SHUT DOWN

To shut down the appliance rotate all control knobs clockwise to the OFF position. The gas supply stopcock or bottle valve should now be closed.

POTS AND PANS

The minimum recommended pan size should have a base diameter not less than 150mm.

The maximum recommended pan size per burner should not exceed a base diameter of 360mm.

Under no circumstances should multiple burners be covered by a single pan or container.

SERVICING, MAINTENANCE AND COMPONENT REPLACEMENT

All servicing, maintenance and component replacement on this appliance should be carried out by one of our recommended service engineers.

SERVICE ACCESS

To access and service the gas control valves - **Recommended every 6 months**

- ◁ Remove the control knobs **CC** and fascia panel **BB** (see below) to gain access to the valves.
- ◁ Remove the two fixing screws **K** securing the valve boss and carefully withdraw the spindle from the valve.
- ◁ Grease as necessary and refit parts. Carry out gas soundness check.

To service the thermocouples – **Recommended every 6 months**

- ◁ Remove the control knobs **D** and fascia panel **C** to gain access to the thermocouples.
- ◁ Check millivolt output and replace if required.
- ◁ Check thermocouples are secure and tighten if required.

Fascia Panel Removal

Remove pan supports **AA** and control knobs **CC**.

Remove drip trays **DD**.

Undo the two fascia panel fixing screws **EE**.

Remove the fascia panel **BB**.

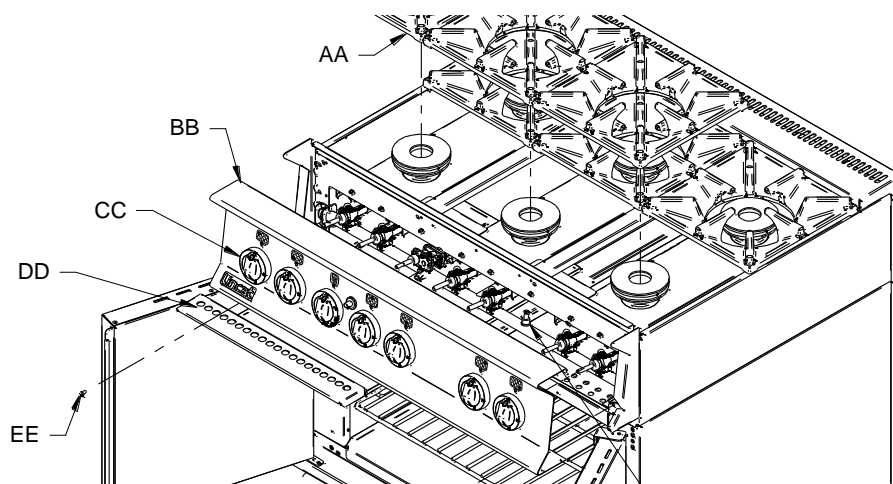

OPERATIONAL CHECK

Commissioning must include an operational check of all controls.

- ◁ Check that each burner can be lit at both full rate and low rate.
- ◁ Check that each burner will remain lit when turned to low rate.

COMPONENT REPLACEMENT

Hob Thermocouple

Remove the pan supports **AA**, covers, burner caps **NN** and burner bodies **MM**.

Remove the top thermocouple lock nut.

Remove thermocouple nut from valve body **B**.

Withdraw the thermocouple.

Fit the new thermocouple and re-assemble in the reverse order.

Control Valve

Remove the control knobs **CC**, covers, pan supports **AA**, burner caps **NN** and fascia panel **BB**.

Remove the nut from the gas output at the valve.

Remove the thermocouple nut from the valve.

Remove clamp screws **K** from the valve.

Free the valve from the manifold **G**.

Fit the new valve and re-assemble reverse order.

Perform gas soundness test of circuit prior to operation of appliance.

Hob Burner

Remove the pan supports, covers and burner caps.

Disconnect the feed pipe.

Remove the burner body retaining screws **JJ**.

Fit the new burner body and re-assemble parts.

FAULT FINDING

Please refer to the Service Help Desk number on the final page of this manual.

< Piezo oven ignitor not sparking.

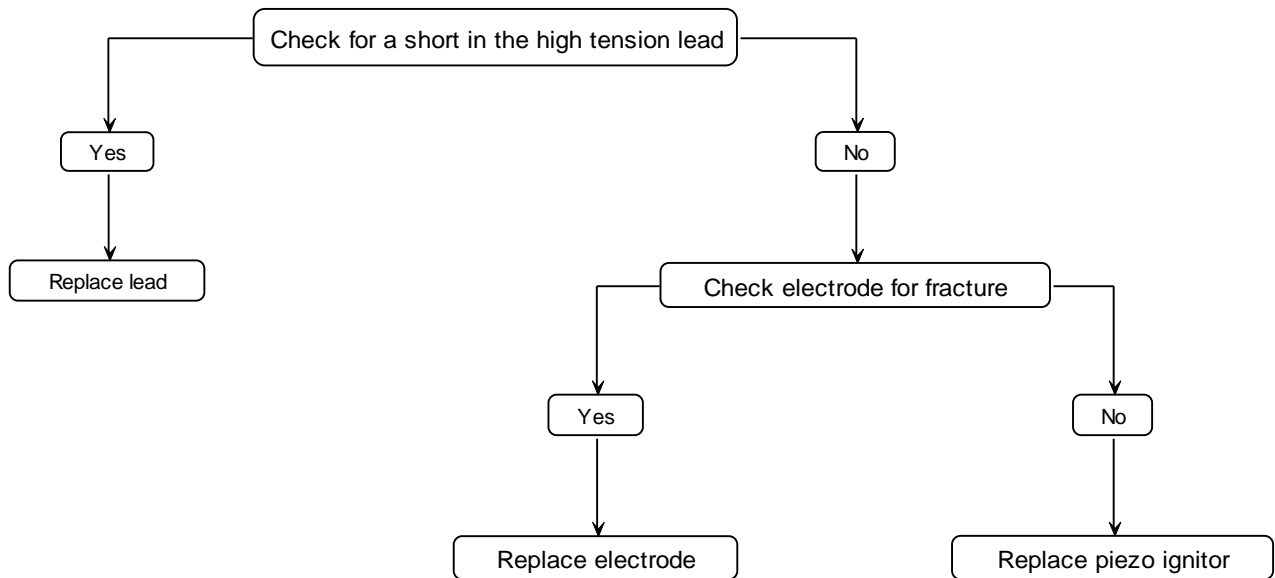

< Burner/s will not light or stay lit

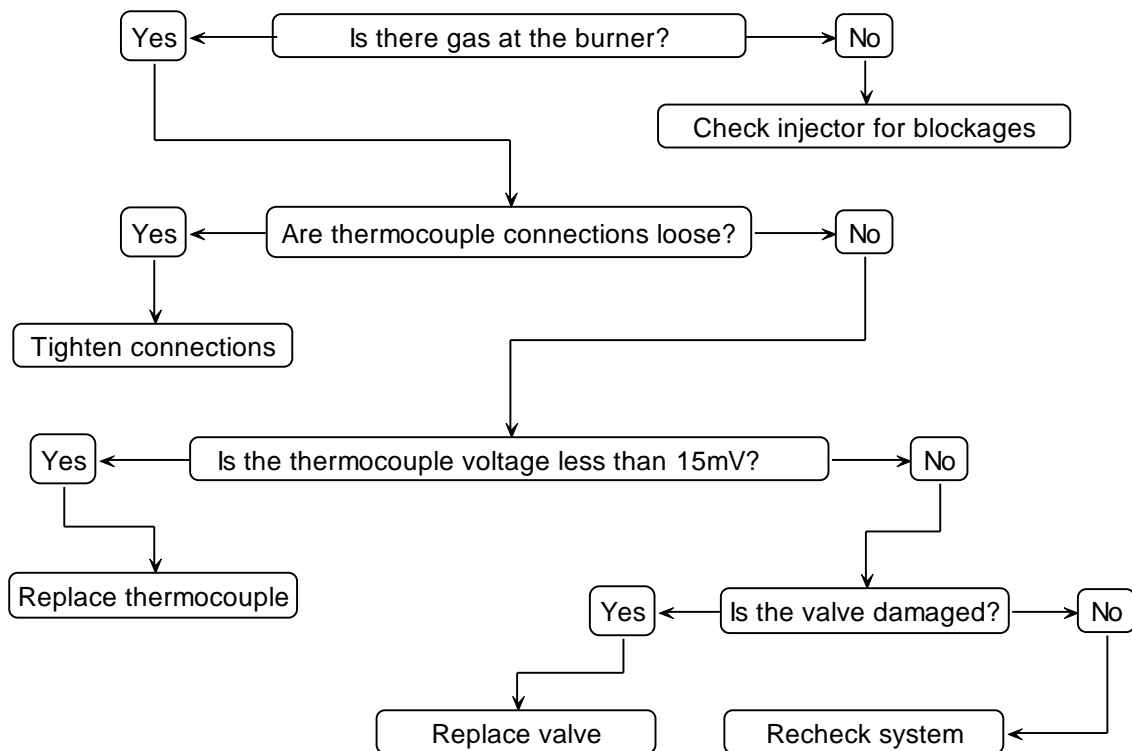

SPARE PARTS LIST

Part number	Part description	OG8003	OG8004	OG8009
BU103	Burner cap	4	6	2
BU104	Burner body	4	6	2
BU106	Injector housing	4	6	2
BU107	Elbow	4	6	2
BU108	Venturi	4	6	2
JE273	Hob burner injector – Natural	4	6	2
JE274	Hob burner injector – Propane	4	6	2
JE275	Hob valve low rate jet - Natural	4	6	2
JE250	Hob valve low rate jet – Propane	4	6	2
KN503	Control knob – Hob burners	4	6	2
FE29	Leg	4	4	4
PA160	Cast pan supports	4	6	2
TC50	Thermocouple 750mm (hob top)	4	6	2
VA74	Hob burner valve	4	6	2

SERVICE INFORMATION

For help with the installation, maintenance and use of your **Lincat** equipment, please contact our service department:

UK: 01522 875520

For non-UK customers, please contact your local Lincat dealer

All service work, other than routine cleaning **MUST** be carried out by qualified personnel and a record kept of any remedial actions taken and at least cover the requirements of the service schedule of this document. We cannot accept responsibility for work carried out by other persons.

To ensure your service enquiry is handled as efficiently as possible, please tell us:

- < Brief details of the problem
 - < Product code
 - < Type number
 - < Serial number
- } All available on serial plate

Lincat reserve the right to carry out any work under warranty, given reasonable access to the appliance, during normal working hours, Monday to Friday, 08:30 to 17:00.

DECLARATION

All Lincat products capable of burning gaseous fuels, satisfy the requirements of the Gas Appliance Regulations 2016/426.

GUARANTEE

This unit carries a comprehensive UK mainland warranty. The guarantee is in addition to, and does not diminish your statutory or legal rights. Contact Lincat for terms and conditions

The guarantee does not cover:

- < Accidental damage, misuse or use not in accordance with the manufacturer's instructions
- < Consumable items (such as filters, glass, bulbs, slot toaster elements and door seals.)
- < Damage due to incorrect installation, modification, unauthorised service work or damage due to scale, food debris build-up, etc.

The manufacturer disclaims any liability for incidental, or consequential damages. Attendance is based on reasonable access to the appliance to allow the authorised personnel to carry out the warranty work.

Service calls to equipment under warranty will be carried out in accordance with the conditions of sale. Unless otherwise specified, a maximum of 15 minutes of administrative time, not spent directly carrying out servicing work, is provided for within the warranty. Any requirement for staff attending the call to spend greater time than 15 minutes due to administrative requirements, such as on health and safety risk assessments, will be chargeable at the prevailing rate.