



Electric Griddle Range
1854/3013/3014/CGR2



British Built for Purpose.





Welcome to Parry

Parry is one of the UK's foremost manufacturers of high-quality Stainless Steel Fabricated Products with a 40-year heritage rooted in British craftsmanship.

At Parry, quality and service are second nature. Striving to exceed our customers' expectations is not just our motto; it's the very heartbeat of our business. Our commitment to our customers is reflected in the **Parry 4E Standard Inspection Body** stating that all our products are:



Easy to use



Easy to maintain



Easy to clean



Easy to repair

Our ranges of Stainless Steel Products have been specifically designed with the consumer in mind and are tailored and compliant to your specific industry sector. All our products are 4E Compliant and meet EU & UK regulations, where applicable. The Parry brand stands for quality, reliability and value.

Our British designed products have been created by our expert in-house development team and manufactured to exacting standards using Industry specified grade of European stainless steel and holding relevant EU & UK certification for all product.

ISO9001 certification and continual investment in the training and development of our highly skilled, artisan workforce means that our clients have genuine peace of mind that they are buying hand crafted, quality products supported by five-star customer service. All Parry products meet EU regulations for their respective sector.

We are LEAN manufacturers, minimising waste, maximising productivity. We are proud to run an operation that is committed to minimising our impact on the environment.

Our equipment and furniture are manufactured in our 45,000 sq ft manufacturing facility in Draycott, Derbyshire in England's industrial heartland. Products are made to order if not available in our stocked items which means you can choose from 600 products, offering over 3,500 variants, with short lead times to suit your specific needs. That means you get exactly what you need when you need it.

Our product information can be found here, in our brochure or on our website www.parry.co.uk.

You have my personal commitment that Parry will exceed your expectations. Should you have any questions please contact your distributor. Alternatively, our customer services team will be happy to help you on **01332 875544**.

Mark Banton MBA
Managing Director



Contents

| | |
|---------------------------------|-------|
| Contents..... | 1 |
| Product Overview | 2-3 |
| Safety Instructions | 4 |
| Installation Instructions | 4 |
| Operating Instructions | 5 |
| Cleaning Instructions | 5 |
| Maintenance Instructions..... | 6 |
| Fault Finding | 7 |
| Service Information..... | 8 |
| Wiring Diagram | 9 |
| Exploded View | 10-15 |
| Parts List | 16-21 |
| Warranty Information..... | 22 |
| Disposal & Recycling | 23 |

Parry Catering Equipment (Midlands) Ltd, Town End Road, Draycott, Derby, DE72 3PT.
Sales Tel: 01332 875544



Product Overview

1854

Powerful and versatile, the Parry 1854 electric griddle is an essential for the modern commercial kitchen, perfect for cooking meat, fish and vegetables. Aesthetically pleasing, it's manufactured from high grade stainless steel ensuring durability and ease of cleaning – while the thermostatic temperature dial and polished plates guarantee absolute cooking control and even heat distribution. The built-in fat drainage drawer allows for continuous use, reducing the time it takes to remove waste from the griddle surface.

3013

Make griddling easy with the Parry 3013 electric griddle. This commercial, high-grade stainless-steel griddle has dual thermostat control and a removable drainage drawer, making it responsive, user-friendly and simple to clean. The heavy-duty stainless-steel cooking plate is powerful and robust, standing up to the rigours of day-to-day commercial use. The dual 3kW elements ensure that the griddle cooks burgers, eggs, bacon and other foods to perfection every time.

3014

Durable, responsive and easy to clean, the Parry electric griddle is constructed from high grade stainless steel with adjustable thermostatic controls. Perfect for use in mobile catering establishments, as well as cafes, restaurants and B&Bs, the griddle is ideal for cooking breakfasts and fast food. The removable drain drawer helps to ensure continued use, reducing the time it takes to remove waste from unit during the day.





CGR2

The CGR2 electric griddle is perfect for use in small to medium-sized catering outlets. This top-grade stainless-steel griddle has a high-quality polished plate, guaranteeing good heat retention and distribution – whilst its easy-to-remove fat drainage drawer ensures that it is exceptionally easy to clean.



Product Overview

These units lead the industry in:

-  Design and aesthetic appeal
-  Performance
-  Power, functionality
-  After sales support

| Features | 1854 | 3013 | 3014 | CGR2 |
|--------------------------------------|-----------------------|-----------------------|-----------------------|-----------------------|
| Unpacked weight (kg) | 37 | 55 | 74 | 22 |
| Packed Weight (kg) | 57 | 75 | 94 | 42 |
| Dimensions (w x d x h) mm | 600 x 520 x 240 | 750 x 520 x 240 | 900 x 520 x 240 | 560 x 365 x 250 |
| Polished plate dimensions (w x d) mm | 600 x 500 | 750 x 500 | 900 x 500 | 560 x 345 |
| Cooking zones | 1 | 2 | 2 | 1 |
| Plug | Yes | Yes | Yes | Yes |
| Power rating | 3kW | 2 x 3kW | 2 x 3kW | 3kW |
| Warranty | 2 years | 2 years | 2 years | 2 years |





Safety Instructions

WARNING



To avoid scratching the highly polished exterior surface of this equipment whilst in transit, the protective film on the exterior surfaces has NOT been removed.

It is IMPORTANT that this protective film is peeled off before the equipment is used.

-  All electrical appliances/parts must be earthed
-  No user-serviceable parts.
-  Isolate power supply before carrying out any installation work.











Installation Instructions

-  Choose a suitable site for your machine taking into consideration its, use, and any heat that may be generated whilst in service.
-  Remove all protect film and packing material and inspect for any damage which may affect the machine's electrical safety.
-  All appliances with an electrical loading above 3 kilowatts must be connected to a suitable supply by qualified electrician, who should ensure that
 - a) Precaution is taken during installation regarding leakage current,
 - b) The means of isolation has a contact separation of at least 3mm on all poles, and
 - c) It is installed in accordance with Health and Safety at Work Act, BS Codes of Practice, IEE Wiring Regulations and Building and Local Authority Standards.









Operating Instructions

-  Ensure all packaging has been removed
-  Turn on mains supply, the red lamp will show to indicate that there is power to the machine
-  On first use, turn the thermostat to 50°C, the green lamp will show to indicate power to the element, leave the unit for approximately 30 minutes, your griddle may smoke, this is normal.
-  Brush the plate surface with vegetable oil, sprinkle on some salt and turn the griddle up to 100°C, when the temperature is reached the green lamp will extinguish
-  It is recommended that at this point sliced bread is placed on top of the plate and left for several minutes, this will extract any dirt on the plate from transit, remove and wipe down the plate.
-  Brush the plate with oil and it is then ready to use.
-  Turn the thermostat dial to the desired temperature, the green lamp will show and will extinguish when the temperature is reached, this procedure will be repeated as the thermostat maintains a constant temperature.
-  If your machine has two sets of controls each side of the griddle can be controlled independently.



Cleaning Instructions

The appliance should be cleaned after every use.

-  Allow unit to cool down before cleaning
-  Before cleaning any unit, and before working on any electrical equipment, **DISCONNECT FROM THE ELECTRICITY SUPPLY**. If the appliance is permanently connected, switch off the mains supply. The control panel or body containing the electrical fixtures must not be immersed in water. All other parts are easily removable for cleaning. All units give best results if kept clean.
-  After using your griddle for a short time you will see a build-up of carbon forming on the griddle surface, this is normal, after each session this carbon **must be removed**, to do this keep the griddle on a low temperature approximately 80°C and scrape with a suitable scraper or griddle stone.
-  If the carbon builds up, it will dry out and start cracking or flaking, **this is not a fault with your griddle surface**
-  If this happens then this surface must be removed and normal scraping will not suffice, a wire brush or griddle stone will be required.
-  Never clean the unit with water jets.



Maintenance Instructions

Ensure the appliance is isolated from the power supply before installing, cleaning or maintaining the appliance.

Maintenance and service must only be undertaken by a qualified electrician.



Parry Catering provides a complete after-sales service by offering the sales of spare parts directly to customers. Buying spares straight from the manufacturer allows customer to experience exceptional value and speedy delivery on all spare parts.

For more information on buying spares visit:

www.parry.co.uk/parry-commercial-catering-spares



Fault Finding

| Fault | Check | Solution |
|---|---|---|
| No power light | Check that the unit is plugged in and power is turned on. | |
| | Plug unit into another socket. | |
| | Check fuse in plug. | If fuse is faulty replace. Still no power. Call engineer |
| Power light on but green light does not illuminate when turning thermostat | Possible thermostat fault. | Call engineer. |
| Power light is on and green indicator light illuminates, but the griddle plate does not heat up. | Possible element fault. | Call engineer. |
| | | |



Service Information

This appliance should be routinely serviced to prolong its lifetime. Parry recommends that the appliance is serviced every 12 months by a Parry authorised engineer. Failure to service your product within the initial 12 month warranty period will cause the 24 month warranty to become void.

If the supply cord becomes damaged, it must be replaced by the manufacturer, it's service agent, or a similarly qualified person.

Enhanced 2 Years Warranty

Parry Catering (Midlands) Ltd offer an enhanced warranty of two years (including parts and labour) on all of the Parry manufactured products. To take advantage of this you should register your warranty by logging onto the company website and filling out our simple form.

www.parry.co.uk/the-parry-warranty

If you have any issues with your product and wish to request a warranty call you can contact our friendly team who will organize a Parry approved service engineer to attend and fix your problem.

All warranty requests can be sent to warranty@parry.co.uk alternatively call our warranty department for technical assistance on **01332 875544**





Wiring Diagram

Models: 1854 / CGR2 / PG6

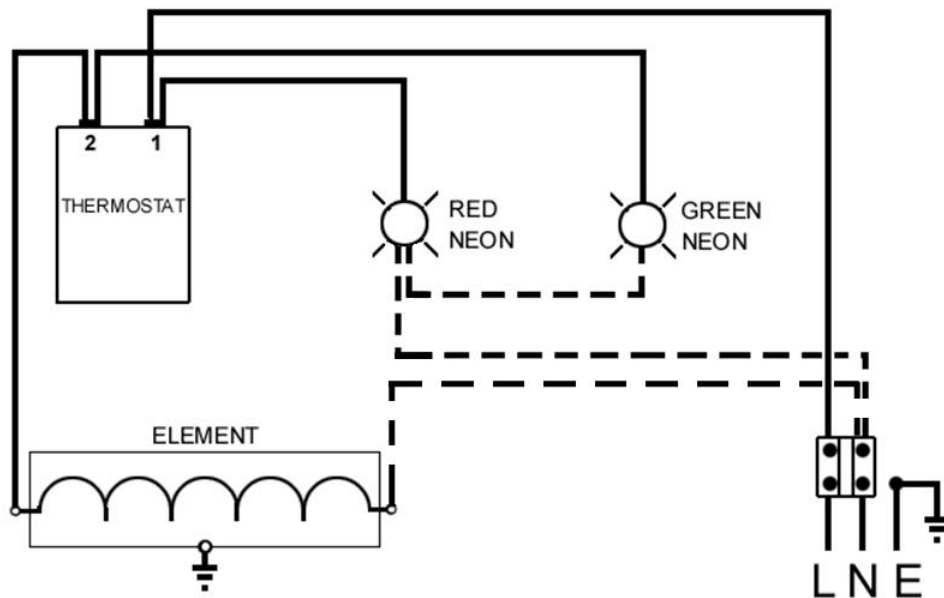

Models: 3013 / 3014 / PG7

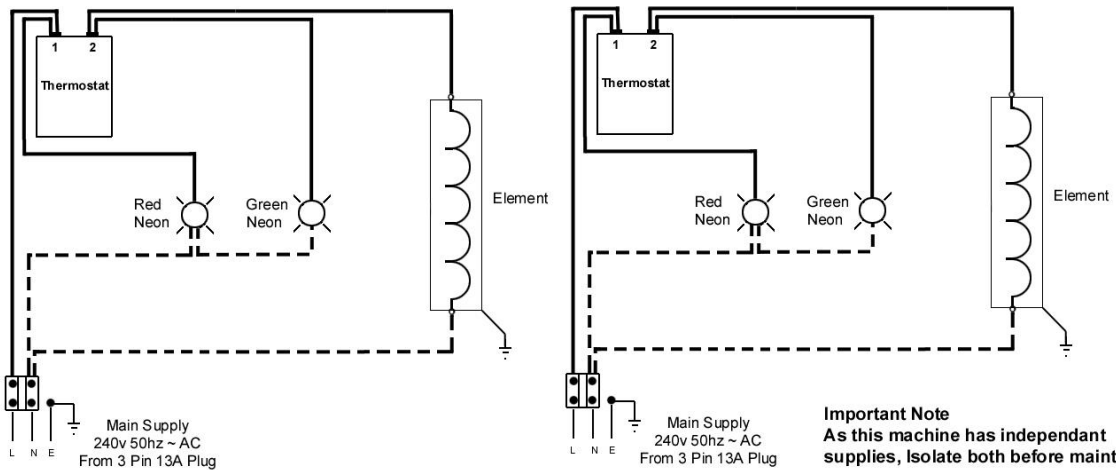



Exploded View

1854 Exploded View

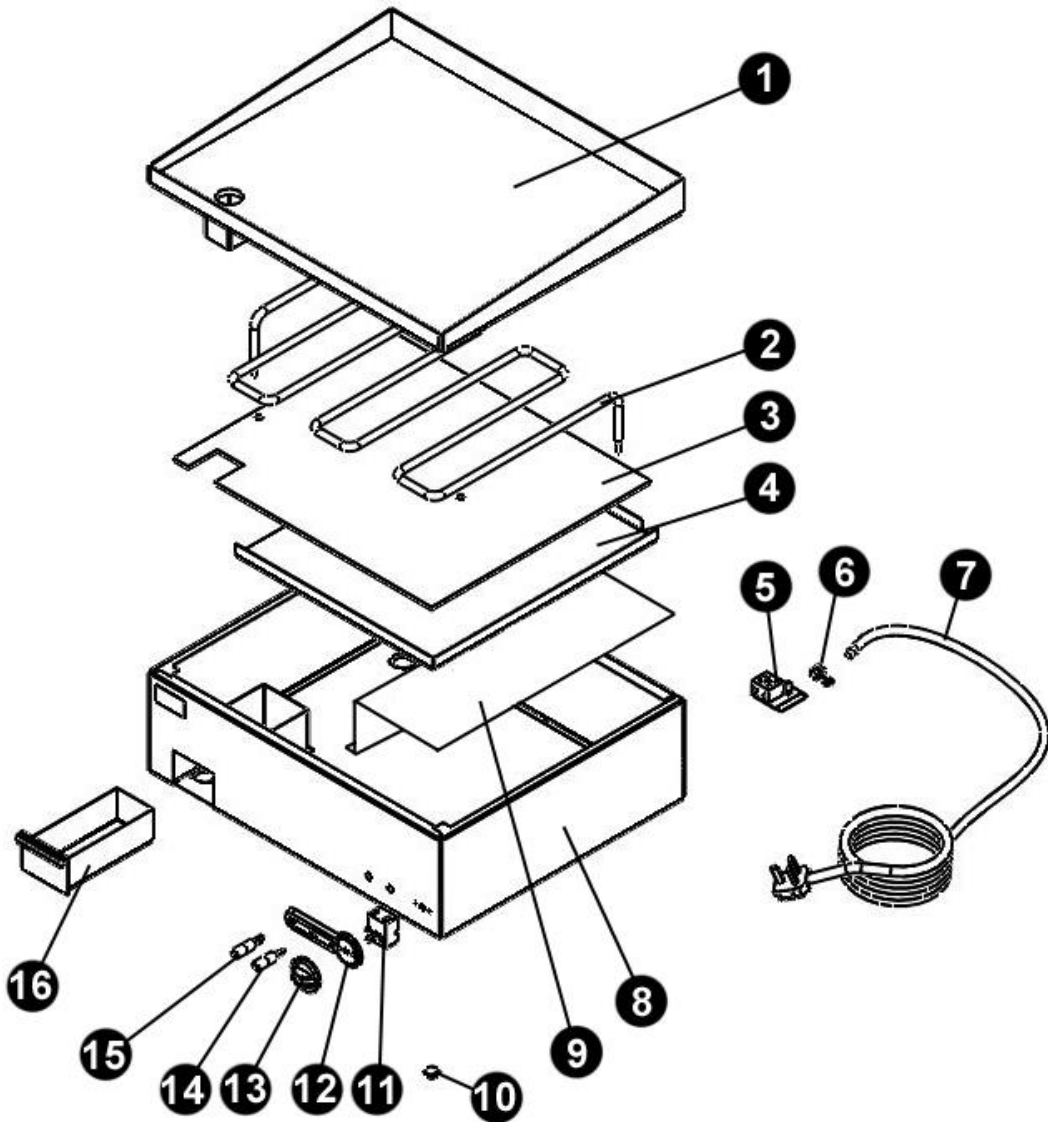



Exploded View

3013 Exploded View

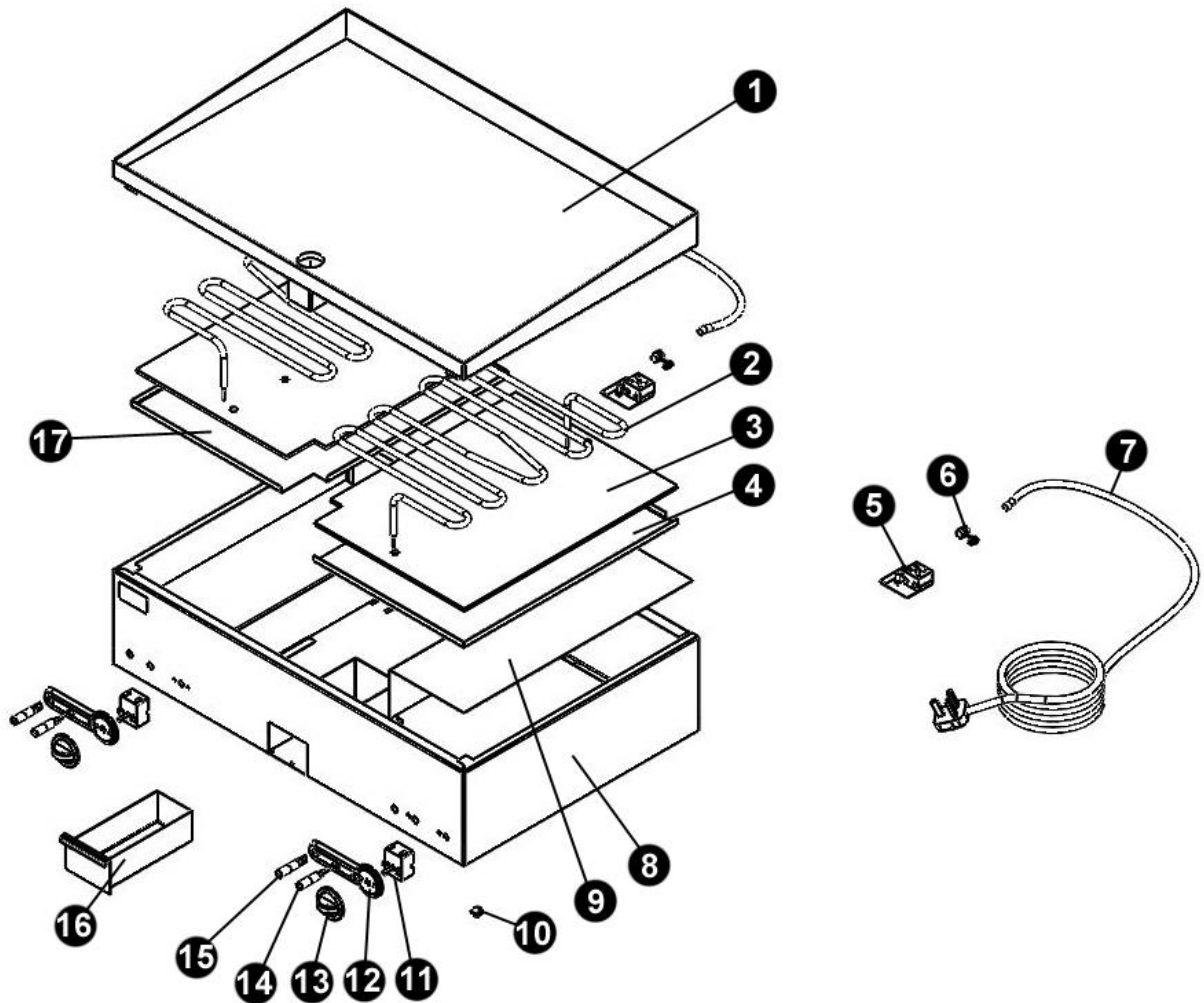



Exploded View

3014 Exploded View

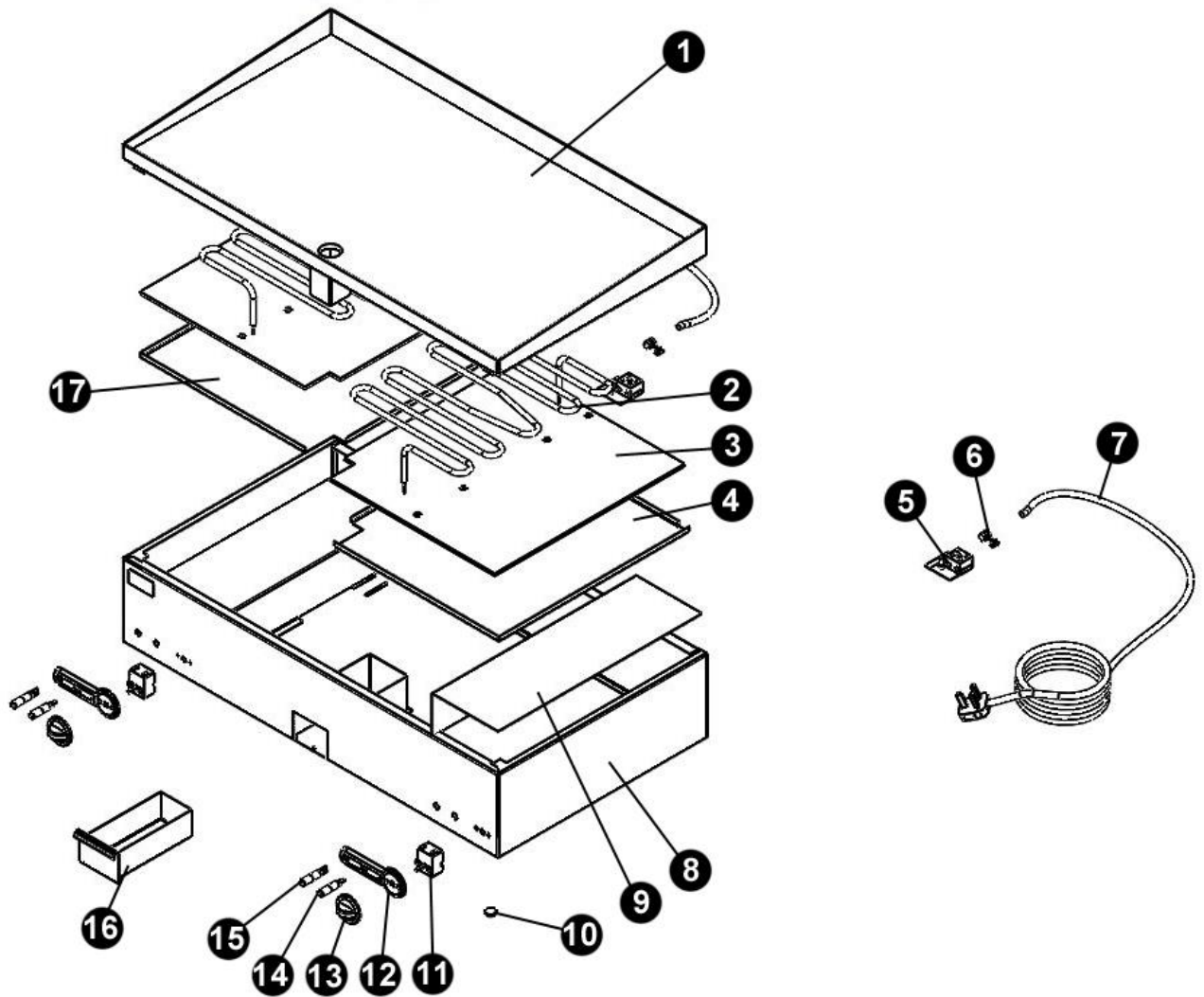



Exploded View

CGR2 Exploded View

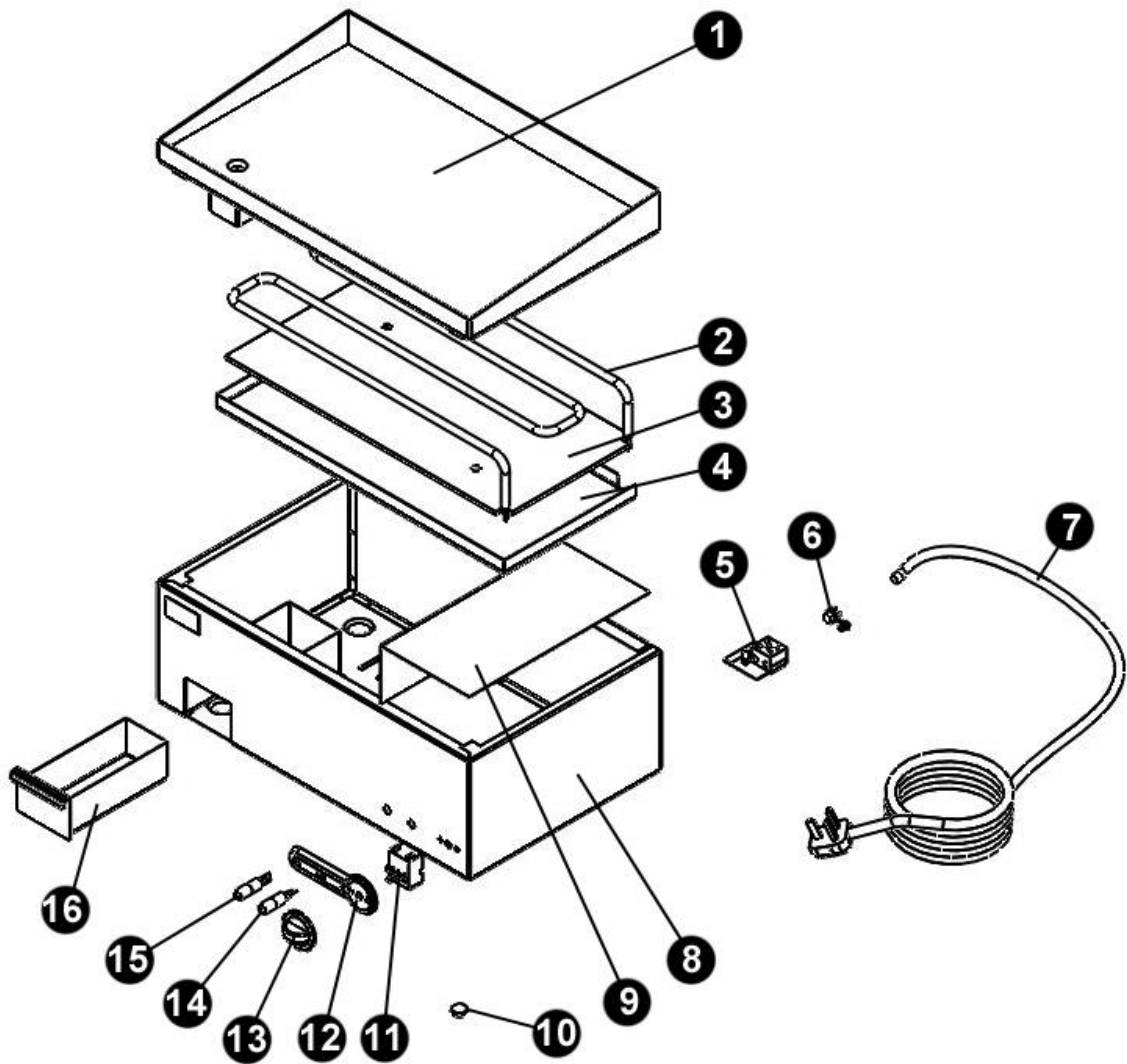



Exploded View

PG6 Exploded View

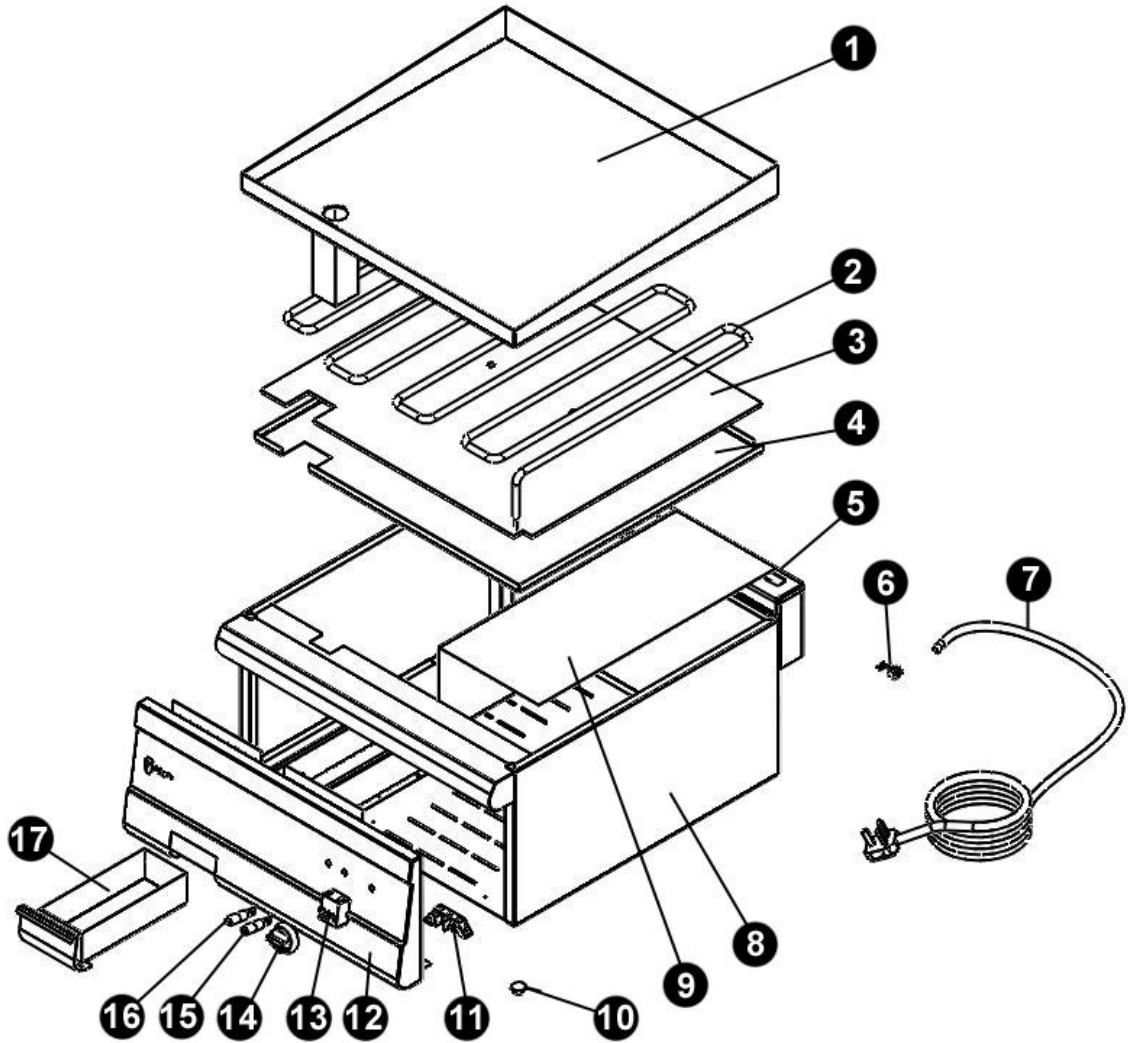



Exploded View

PG7 Exploded View

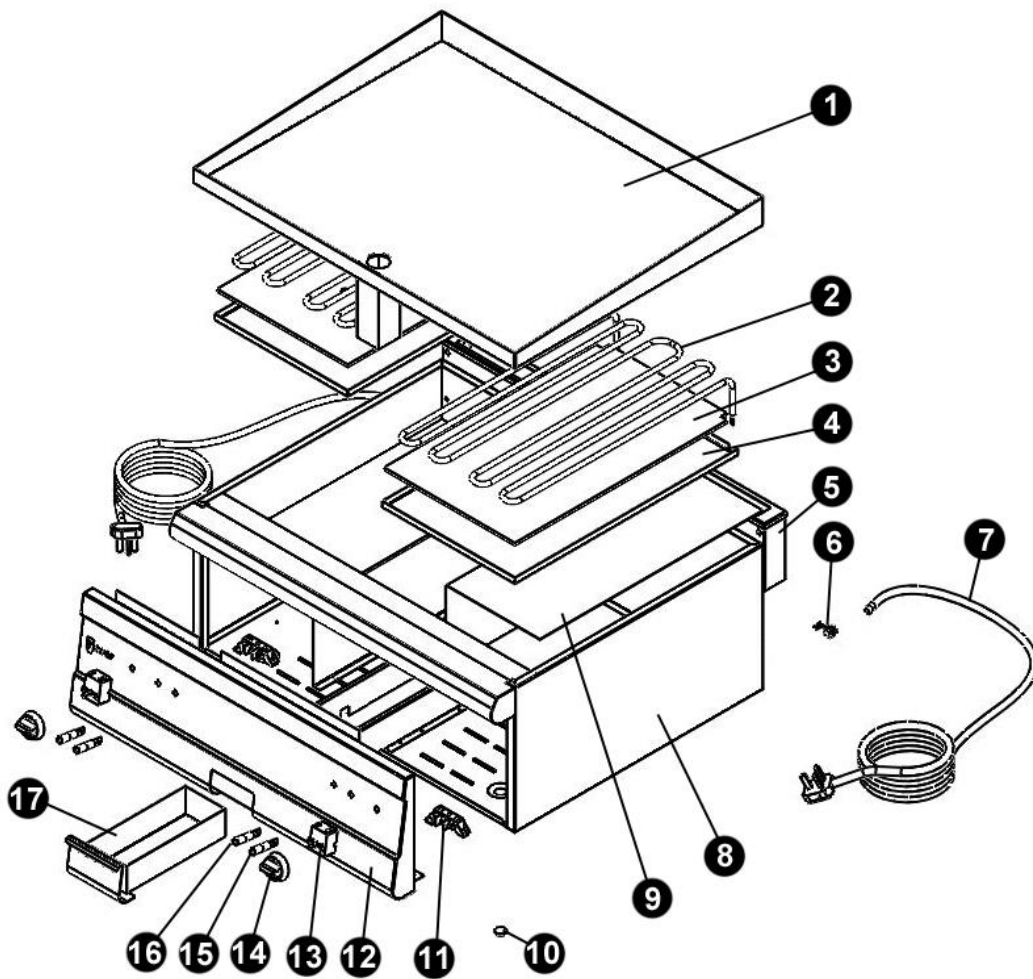



Parts List

1854 Parts List

| Part Number | Description | Code |
|-------------|----------------------|-----------|
| 1 | Griddle Plate | GP1854 |
| 2 | Element | ELGR09123 |
| 3 | LTI Insulation Board | ASPC01854 |
| 4 | *Element Tray | *No Code |
| 5 | Terminal Bracket | TERMBRKT2 |
| 6 | Cable Bush | BUSR06003 |
| 7 | Mains Cable | MAINSLEAD |
| 8 | *Body | *No Code |
| 9 | *Wire Guard | *No Code |
| 10 | Rubber Foot | RUBBRFOOT |
| 11 | Thermostat | TMST13062 |
| 12 | Bezel | BEZELCBOX |
| 13 | Control Knob | KNOBTYPEC |
| 14 | Red Neon | LNRE2211P |
| 15 | Green Neon | LNGN2211P |
| 16 | *Fat Drawer | *No Code |
| | | |
| | | |
| | | |

*Metalwork Components



Parts List

3013 Parts List

| Part Number | Description | Code |
|-------------|----------------------|-----------|
| 1 | Griddle Plate | GP3013 |
| 2 | Element | ELGR03000 |
| 3 | LTI Insulation Board | ASPC03013 |
| 4 | *RH Element Tray | *No Code |
| 5 | Terminal Bracket | TERMBRKT2 |
| 6 | Cable Bush | BUSR06003 |
| 7 | Mains Cable | MAINSLEAD |
| 8 | *Body | *No Code |
| 9 | *Wire Guard | *No Code |
| 10 | Rubber Foot | RUBBRFOOT |
| 11 | Thermostat | TMST13062 |
| 12 | Bezel | BEZELCBOX |
| 13 | Control Knob | KNOBTYPEC |
| 14 | Red Neon | LNRE2211P |
| 15 | Green Neon | LNGN2211P |
| 16 | *Fat Drawer | *No Code |
| 17 | *LH Element Tray | *No Code |
| | | |
| | | |

*Metalwork Components



Parts List

3014 Parts List

| Part Number | Description | Code |
|-------------|----------------------|-----------|
| 1 | Griddle Plate | GP3014 |
| 2 | Element | ELGR03000 |
| 3 | LTI Insulation Board | ASPC03014 |
| 4 | *RH Element Tray | *No Code |
| 5 | Terminal Bracket | TERMBRKT2 |
| 6 | Cable Bush | BUSR06003 |
| 7 | Mains Cable | MAINSLEAD |
| 8 | *Body | *No Code |
| 9 | *Wire Guard | *No Code |
| 10 | Rubber Foot | RUBBRFOOT |
| 11 | Thermostat | TMST13062 |
| 12 | Bezel | BEZELCBOX |
| 13 | Control Knob | KNOBTYPEC |
| 14 | Red Neon | LNRE2211P |
| 15 | Green Neon | LNGN2211P |
| 16 | *Fat Drawer | *No Code |
| 17 | *LH Element Tray | *No Code |
| | | |
| | | |

*Metalwork Components



Parts List

CGR2 Parts List

| Part Number | Description | Code |
|-------------|----------------------|-----------|
| 1 | Griddle Plate | GPCGR2 |
| 2 | Element | ELGROCGR2 |
| 3 | LTI Insulation Board | ASPC0CGR2 |
| 4 | *Element Tray | *No Code |
| 5 | Terminal Bracket | TERMBRKT2 |
| 6 | Cable Bush | BUSR06003 |
| 7 | Mains Cable | MAINSLEAD |
| 8 | *Body | *No Code |
| 9 | *Wire Guard | *No Code |
| 10 | Rubber Foot | RUBBRFOOT |
| 11 | Thermostat | TMST13062 |
| 12 | Bezel | BEZELCBOX |
| 13 | Control Knob | KNOBTYPEC |
| 14 | Red Neon | LNRE2211P |
| 15 | Green Neon | LNGN2211P |
| 16 | *Fat Drawer | *No Code |
| | | |
| | | |
| | | |

*Metalwork Components



Parts List

PG6 Parts List

| Part Number | Description | Code |
|-------------|----------------------|-----------|
| 1 | Griddle Plate | GPCPG6 |
| 2 | Element | ELGR09154 |
| 3 | LTI Insulation Board | ASPCPG6 |
| 4 | *Element Tray | *No Code |
| 5 | *False Flue | *No Code |
| 6 | Cable Bush | BUSR06003 |
| 7 | Mains Cable | MLEAD25 |
| 8 | *Body | *No Code |
| 9 | *Wire Guard | *No Code |
| 10 | Rubber Foot | RUBBRFOOT |
| 11 | Terminal Bracket | TB3POLETB |
| 12 | *Fascia | *No Code |
| 13 | Thermostat | TMST13062 |
| 14 | Control Knob | KNOBPHEN |
| 15 | Red Neon | LNRE2211P |
| 16 | Green Neon | LNGN2211P |
| 17 | *Fat Drawer | *No Code |
| | | |
| | | |

*Metalwork Components



Parts List

PG7 Parts List

| Part Number | Description | Code |
|-------------|----------------------|-----------|
| 1 | Griddle Plate | GPCPG7 |
| 2 | Element | ELGR0PG7 |
| 3 | LTI Insulation Board | ASPCPG7 |
| 4 | *Element Tray | *No Code |
| 5 | *False Flue | *No Code |
| 6 | Cable Bush | BUSR06003 |
| 7 | Mains Cable | MLEAD25 |
| 8 | *Body | *No Code |
| 9 | *Wire Guard | *No Code |
| 10 | Rubber Foot | RUBBRFOOT |
| 11 | Terminal Bracket | TB3POLETB |
| 12 | *Fascia | *No Code |
| 13 | Thermostat | TMST13062 |
| 14 | Control Knob | KNOBPHEN |
| 15 | Red Neon | LNRE2211P |
| 16 | Green Neon | LNGN2211P |
| 17 | *Fat Drawer | *No Code |
| | | |
| | | |

*Metalwork Components



Warranty Information

The manufacturer's warranty is only valid in the UK mainland. Northern Ireland, Western Isles, Inner Hebrides and Islands are parts only warranty. Please be aware that the warranty starts from the date of purchase from Parry and not the sale or installation date of the equipment.

To be eligible for a 2 year warranty, products must be serviced at least once within the first 12 months of purchase.

All service calls will be carried out between 8am and 5pm, Monday to Friday.

Your warranty is invalid if your equipment has not been installed in accordance with the manufacturer's instructions. The misuse, alteration or unauthorised repairs of the equipment will also invalidate the warranty.

During the warranty period it is at Parry's discretion whether to repair or replace the equipment.

The warranty only applies if the equipment has been used in a professional manner following the manufacturer's instructions and maintenance guidelines.

The warranty covers defects in the material and component failure only. We are not liable for trading loss, loss of perishable items, water damage or loss due to injury or fire damage.

Please ensure you have referred to the manufacturer's instruction before placing a warranty call.

Contact our warranty department on **01332 875544** for technical assistance.











Please have your model number ready before calling.

All warranty requests must be submitted to warranty@parry.co.uk.

Failure to pay any warranty charges will result in your warranty being put on hold until the bill has been settled. Any issues regarding the raised charges should be put in writing to our warranty department for further investigation.

Register your product by visiting our website www.parry.co.uk

Not covered under warranty

-  Fault due to incorrect installation, poor maintenance or equipment abuse.
-  Resetting of equipment or circuit breakers.
-  Faulty electrics – e.g. customer's plug socket, plug, wiring, junction box fault, wrong fuse.
-  Products must be serviced within the first 12 months to be eligible for the 2 year warranty
-  Product not covered by warranty if combustible materials have been used, e.g. plastic trays.
-  Foil used on racks, blockages and lime scale issues.
-  Failure to grant access for pre-arranged service call.
-  Equipment that has been set up or used incorrectly e.g. dishwasher detergents, levelling and setting up of doors on a six burner cooker.
-  Excessive carbon build-up on griddle plates or overuse of lava rock on chargrills. (Recommended use by Parry no more than 2kg.)
-  All of the above points are not covered by warranty and any costs incurred, because of the above, will be forwarded to the parties responsible for placing the call.



Disposal & Recycling

This appliance is marked according to the European Directive 2002/96/EC on Waste Electrical and Electronic Equipment (WEEE).

By ensuring this product is disposed of correctly, you will help prevent potential negative consequences for the environment and human health which could otherwise be caused by inappropriate waste handling of this product.

A symbol on the product, or on the documents accompanying the product, indicates that

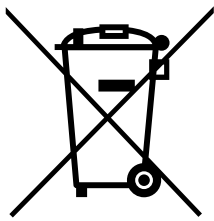

this appliance may not be treated as household waste. Instead it should be handed over to the applicable collection point for the recycling of electrical and electronic equipment.

Disposal must be carried out in accordance with local environmental regulations for waste disposal.





For more detailed information about treatment, recovery and recycling of this product, please contact your local city office, your household waste disposal service or the shop where you purchased the product.

Parry Catering recognises our obligations to the EU DIRECTIVE covering the waste disposal of electrical and electronic equipment (WEEE). Parry Catering are committed to this policy in order to help conserve the environment.

At the end of this unit's life you **MUST** dispose of it in an approved manner. You **MUST** not discard the unit or place it in the refuse bin.

You have several options:

-  Take the unit to an approved WEEE scheme company, there will be one in your area.
-  Take the unit to an approved waste disposal site; many sites are managed by your local authority.
-  Contact the units manufacturer, importer or their agent; the contact details will be on the unit.

There will probably be a charge for this service which will depend on the physical size and location of the unit. You will be given a collection price for a curb side collection based on commercial rates prevailing at the time.

It should be noted that the unit to be collected should be suitably packed and sealed to prevent dangerous gases and fluids from escaping. The condition of the unit must also be clean to comply with health and safety regulations.