

Instruction Manual
Model: GB6 /GB6P
6 BURNER OVEN



Built for purpose in Britain







Welcome to Parry...

We're proud to bring you quality stainless steel products that are designed for daily use – and built for purpose – right here in the UK.

When you work with us, you don't just benefit from our commitment to British craftsmanship. Our agile approach – combined with bespoke service – means that we're quickly able to adapt every aspect of our offering to fit your requirements.

-  With over 40 years' experience in commercial catering, our equipment heats quickly, cooks beautifully and cleans easily.
-  From food display units with specialist lighting to bespoke cupboard designs, our R&D team develop and refine products until they're precisely what you need.
-  Our extensive expertise and comprehensive support deliver benefits that go way beyond products leaving the factory.

If you have comments or questions, we'd be pleased to hear from you.

Contact us by calling **01332 875544** or visiting **www.parry.co.uk/contact-us**.



Contents	3
Product Overview	4
Safety Instructions	5
Installation Instructions	6
Operation Instructions	8
Maintenance Instructions	10
Cleaning Instructions	10
Fault Finding	11
Replacement Parts	12
Natural Gas – Conversions Instructions	13
LPG – Conversion Instructions	14
Conversion Procedure	15
Technical Information	18
Parts List	19
Disposal and Recycling	21
Warranty Information	22



Product Overview

The GB6 outperforms every six burner oven on the market. Beating it's competitors on aesthetic appeal, functionality and performance. The GB6 features six powerful burners and a double-door gas oven. It comes as standard with a duplex chassis for added rigidity and removable cast-iron pan supports for easy cleaning. The oven is also easy to clean with vitreous enamel lining and provides great versatility with three shelf positions. The range is provided with castors fitted as standard (two braked)



Unpacked weight (kg)	150
Packed weight (kg)	170
Dimensions (w x d x h) mm	900 x 790 x 970
Warranty	3 Years
KW – Natural	40.144
KW – Propane	34.173
BTU – Natural	136,821
BTU – Propane	116,599
Input Gas Connection	Male 3/4" BSP
GAS INPUT PRESSURE – Natural	20mb / 8" W.G
GAS INPUT PRESSURE – Propane	37mb / 14.8" W.G.
Can be converted using conversion kit?	Yes



IMPORTANT

PLEASE READ INSTRUCTIONS FULLY BEFORE USE **INSTALLATION INSTRUCTIONS**

THIS APPLIANCE IS ONLY FOR PROFESSIONAL USE AND MUST ONLY BE USED BY QUALIFIED PEOPLE.

Attention should be drawn to the fact that parts of this unit by necessity, will get VERY HOT, and will cause burns if touched accidentally. Therefore it is the responsibility of the supervisor or equivalent to provide SUITABLE PROTECTIVE CLOTHING for the user.

THIS APPLIANCE MUST BE FITTED AND TESTED BY A REGISTERED FITTER BEFORE USE.

The unit should be installed in compliance with the INSTALLATION INSTRUCTIONS and the NATIONAL REGULATIONS in force at the time. Particular attention should be paid to the Gas Safety (Installation and Use) Regulations and the Health and Safety at Work Act.

All commercial gas catering equipment is recommended to be mounted below an extraction canopy. Please consult a ventilation engineer or refer to Guidelines DW172 to calculate the ventilation requirements for cooking areas containing different pieces of gas catering equipment.

Each appliance requires a flow of fresh air for combustion. Under no circumstances should air vents on the appliances, or air vents installed by the fitter in the room of the appliance to supply combustion air, be altered or omitted in any way.

To prevent shocks, all appliances whether gas or electric, must be earthed.

ANY GAS CONVERSIONS NEEDED TO BE MADE TO THE PRODUCT MUST BE CARRIED OUT BY A GAS SAFE REGISTERED ENGINEER

To avoid scratching the highly polished exterior surface of this equipment whilst in transit, the protective film on the exterior surfaces has NOT been removed.

It is IMPORTANT that this protective film is peeled off before the equipment is used.



Installation Instructions

ALL APPLIANCES MUST BE FITTED AND OR CONVERTED BY A REGISTERED INSTALLER, IN ACCORDANCE WITH CURRENT REGULATIONS.

INSTALLATION

Before installation check data plate on rear of unit to ensure appliance is suitable for gas supply available.

During installation provision must be provided for combustion air to the appliance through base and rear of appliance. This should not be blocked at any time. This appliance should be installed with sufficient ventilation to prevent the occurrence of unacceptable concentrations of substances harmful to health in the room in which it is installed.

POSITIONING

The appliance must not be installed on or against combustible surfaces – minimum clearances must be :

Rear 150mm (6")
Sides 150mm (6")
Hotplate to combustible material 1525mm (60")

All local fire regulations should be observed.

It is recommended that the appliance be sited below a ventilating hood preferably of the extractor type incorporating a grease filter.

The cooker is manufactured with four castors two of which are braked. Caution should be taken when manipulating or moving the unit. The appliance should be attached to a wall with a chain to restrict the movement of the unit once connected to the gas supply. When the unit is installed in position the brakes should be on.

Ensure the appliance is level, by placing a spirit level on the shelf in the oven, not on the pan supports! All four castors are adjustable. To alter the height of the unit loosen the locking grub screw with an M3 allen key.

Next turn the large nut on the wheel assembly to either raise or lower the unit. When you are happy with the height, tighten the locking grub screw with the M3 allen key.

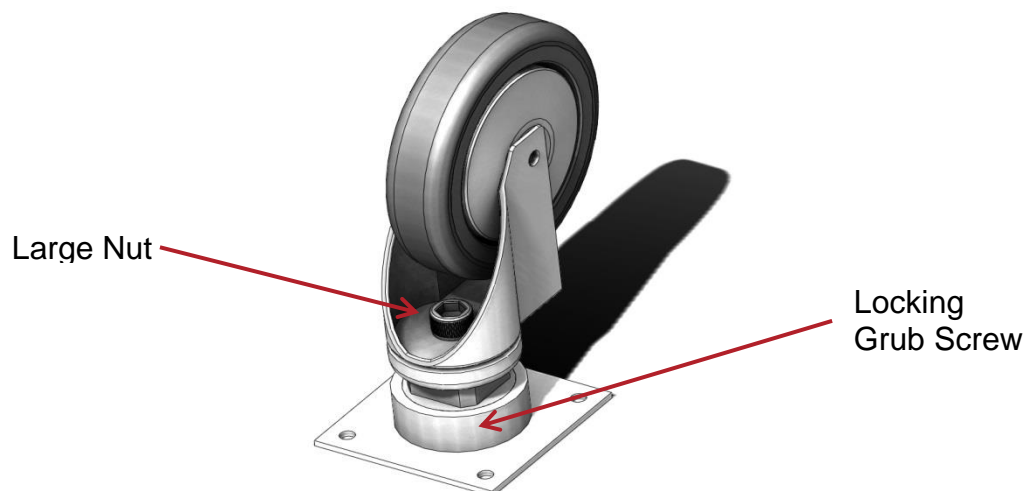



Installation Instructions

The oven doors are held shut by adjustable roller catches. When installing the appliance ensure the catches are set to allow the door to close firmly. To adjust the catch, use a screwdriver to press in roller to below the plate, turn clockwise to adjust downward, and anti-clockwise to lift the roller.



GAS CONNECTION

The size of the supply pipe should be no less than 3/4" B.S.P. and an easily accessible isolation tap fitted close to the appliance in the gas line. Although a rigid connection is recommended. An approved armoured flexible pipe may be used in conjunction with a straining cable.

Before the appliance is commissioned the gas safety regulations require that all connections on the gas line are tested for gas soundness between the gas meter and the appliance.

All packing and protective film must be removed from panels etc. prior to commissioning the appliance. All gas appliances must be fitted by a competent person to gas safety regulations in force.

Gas hoses used to connect the appliance to the gas supply must be of the correct specification for the gas and pressure of the appliance. The gas hose must comply with the national requirements in force, and be CE marked, of a metal braided construction suitable for commercial catering equipment. The hoses should be periodically examined and replaced as necessary

The tube or hose shall be fitted such that there are no sharp bends or torsional strain which may cause damage or failure of the tube or hose, especially near the end fittings. Torsional strain can be prevented by the use of internal unions, swivel joints, etc. The bend radius should not exceed that stated by the Manufacturer. The hose should not touch the ground and should be no longer than 1.5m long.

A manual valve should be positioned upstream of the tube or hose unless the connection fitting incorporates a self-sealing quick release coupling.

Where a quick release coupling is used for horizontal travel such as in commercial catering appliances it is advisable that the coupling is facing downwards to prevent the ingress of debris and ensure the hose is formed in to a smooth curve.

All units should have a restraining cable fitted preventing the unit from being pulled away from the wall and causing the gas hose to become disconnected accidentally.





Operation Instructions

FOR FITTING INSTRUCTIONS SEE INSTALLATION SECTION.

Operating the hob

All burners are fitted with flame failure devices.

1. To light hob unit turn knob to 
2. Press in and ignite gas with a match, keep knob held in for 15-20 seconds.
3. Release knob, gas should stay lit, if gas goes out repeat stage 2
4. The burner is now on full gas, to turn gas down turn knob anti-clockwise, this is the  lowest setting, which is factory set.
5. To turn burners off, turn knob clockwise all the way round.

Parry recommends that the hob is used only with pans that have a minimum diameter of 120mm, and up to a maximum of 295mm diameter. This ensures that there is satisfactory combustion, and the pan is stable as it sits on the finger of the pan support.

Operating the oven

1. To light oven, open doors, turn oven knob to approximate gas mark 5 and hold tap knob in, at the same time press the piezo ignitor button on bottom of the oven.
2. After pressing button 2-3 times burner should light.
3. Keep oven knob depressed for 15-20 seconds.
4. Release knob and flame should remain lit, if not repeat above sequence.
5. If burner goes out refer to fault finding chart.
6. When burner stays on oven is ready for use, select gas mark required, turn knob to setting, oven flame will decrease when desired temperature is reached.

Please take care when opening and closing the doors of an oven that has been turned on. Surfaces and handles will get hot. The surfaces within the oven chamber will be very hot so it is advisable to wear oven gloves to protect from burns that may be incurred from touching hot surfaces within the oven.

We advise these appliances should not be left unattended while switched on. These appliances are for professional use by qualified people only. There are no user serviceable parts.

It is recommended that the sealed top plate is cleaned regularly to prevent build up of fat and grease.

There are three shelf positions in the oven, the following guide is only intended as a guide to temperature in the centre of the oven. It is strongly recommended that the user makes note of best results, temperatures can vary as much as 20°C hotter at top of oven and 30°C cooler at the bottom of the oven.



Operation Instructions

These temperatures are measured in an empty oven.

MARK	1	2	3	4	5	6	7	8	9
°C	140	150	165	180	200	220	235	245	260
°F	275	300	328	350	392	425	440	465	500

Cooking Chart – the following chart is for guidance only.

USAGE	PRODUCT	GAS TEMP
HIGH TEMP.ROASTING	MEAT OR POULTRY	6 OR 7
LOW TEMP.ROASTING	MEAT OR POULTRY	3
HIGH TEMP.BAKING	BREAD OR SCONES	8
LOW TEMP. BAKING	SLAB CAKE	2
PUDDINGS }	MILK PUDDING BAKED CUSTARD	3
PASTRY }	SHORT CRUST PLATE TARTS FLAKY	7











Maintenance Instructions

MAINTENANCE AND SERVICE MUST ONLY BE UNDERTAKEN BY REGISTERED FITTERS.

PLEASE NOTE THE LOW RATE ADJUSTER ON THE UNIT HAS BEEN FACTORY SET AND SHOULD NOT BE ADJUSTED UNLESS BY A QUALIFIED ENGINEER IN WHICH CASE THE LOW RATE ADJUSTER SHOULD BE RE-SEALED.

Parry recommends that this unit is serviced at least every 6 months

As part of a full service we recommend the following checks are carried out.

-  Before any maintenance isolate the appliance from the gas supply
-  Examine and clean all burner and flame retention ports.
-  Using a combination of brushes, remove dust and lint from within the primary air ports venturi and burners. Check the burner aeration to ensure it is clear of debris.
-  Clean burner injectors ensuring orifices are not enlarged or damaged.
-  Stiff gas controls can in some instances be greased. Please ensure the correct type of grease is used.
-  Check any ignition electrodes and high tension leads where fitted. Clean and adjust where necessary
-  Check Door seal for damage and condition.
-  Reconnect gas supply and test all disturbed gas connections for gas tightness using a non-corrosive leak detection fluid.
-  Check the appliance burner operating pressure, heat input rating or where necessary both.



Cleaning Instructions

It will be found that it takes less time and effort to clean the hob every time it has been used, particularly whilst still warm before grease and spillages are burnt on. Proprietary cleaners must be used with care – they are highly corrosive and may cause damage to surfaces and components. The stainless outer panels require a wipe down with warm soapy water.

DO NOT USE SCOURING PADS.

The internal walls of the oven have been vitreous enamelled to make them easy to clean. The oven has two wire shelves and one vitreous enamelled bottom tray. These can be removed for cleaning but the lower tray must be in position when the appliance is being used.



Fault Finding

FAULT	POSSIBLE CAUSE	REMEDY
HOB		
Incorrect flame picture, flame lift or noisy burner	Incorrect burner pressure, Blocked or partially blocked injector. Inadequate ventilation. Burner faulty/corroded/blocked	Check/adjust burner pressure Check /clean injector, Check ventilation. Check / clean burner and replace as necessary.
Burners will not stay alight	Faulty connection at thermocouple-valve, incorrectly located	Remake connection, reposition thermocouple
Burner goes out when turned to "low"	Blockage in tap	Clean and re-grease
Irregular flame	Burner ring/cap not correctly located, or low pressure	Relocate and check pressure at test point.
OVEN		
Failure to ignite	Dirt or grease broken or loose connection	Clean reconnect / replace H.T.Lead
	Incorrect spark gap	Set gap 3-4mm
Burner fails on low rate	Loose Thermocouple	Replace
	Faulty Magnet in F.F.D.	Replace thermostat
Burner fails on low rate	Thermocouple out of position.	Reposition



Replacement Parts

For Gas Safe Engineers only

HOB TAP- Remove pan supports, pull off control knobs and unclip fascia panel. Disconnect burner supply tube and thermocouple. Undo the 2 screws securing the tap to the rail. Check sealing washer and replace if necessary. Assemble in reverse order.

HOB BURNER/THERMOCOUPLE – Remove Pan Supports and Burner caps. Remove the solid top tray. Disconnect thermocouple from rear of tap. Undo locknut on burner mounting channel. Assemble in reverse order.

OVEN THERMOSTAT - Proceed as for hob tap. Slide thermostat phial from housing inside oven. Remove through hole in the top of the oven on right hand side. Assemble in reverse order.

OVEN THERMOCOUPLE - Remove the bottom oven tray. Inside the oven disconnect the thermocouple from the extension piece. Undo locknut holding thermocouple to oven burner. Assemble in reverse order. Ensure locknut is securely tightened.

OVEN BURNER/IGNITON - Remove oven base. Disconnect oven supply tube, H.T.lead and thermocouple. Burner is held in by 2 screws. Piezo spark generator is secured by a locknut. Electrode secured to burner bracket by centre screw.



NAT GAS - Conversion Instructions

Product **GB6 – 6 Burner Oven LPG**

For use with models with the following serial numbers

Model	From	To
GB6P		

These instructions can be used for converting from LPG to Natural Gas

LPG units are designed and tested in accordance with all current regulations enforced to run on the following gases only

PLEASE NOTE

This conversion must be carried out by a Gas Safe Registered Engineer.

This conversion kit includes

	Description	Product Code	Quantity
Hob valve bypass screw	NAT GAS Hob valve bypass screw stamped with 85	COPBPS - 85	6
Hob burner injector	NAT GAS Hob Burner Injector stamped with 185	HOBINJECT185	6
Oven valve bypass screw	NAT GAS Oven valve bypass screw stamped with 70	COPBPS - 70	1
Oven burner injector	NAT GAS oven burner injector stamped with 220	INJECT220	1
Labels		NAT. GAS ONLY	1
Instructions		CONVIN44-1	1



LPG - Conversion Instructions

Product **GB6 – 6 Burner Oven**

For use with models with the following serial numbers

Model	From	To
GB6		

These instructions can be used for converting from Natural Gas to LPG

LPG units are designed and tested in accordance with all current regulations enforced to run on the following gases only

Propane G31 @ 37mbar 14.8" W.G.

PLEASE NOTE

This conversion must be carried out by a Gas Safe Registered Engineer.

This conversion kit includes

	Description	Product Code	Quantity
Hob valve bypass screw	LPG hob valve bypass screw stamped 50	COPBPS-50	6
Hob burner injector	LPG hob burner injector stamped 105	HOBINJECT105	6
	LPG oven valve bypass screw stamped 50	COPBPS-50	1
	LPG oven burner injector stamped 150	INJECT150	1
Labels		G31 ONLY,	1
Instructions		CONVIN43-1	1



Conversion Procedure

Conversion Procedure for GB6

Warning

Ensure the appliance is isolated from the gas supply before commencing conversion

Remove pan support and burner caps / aluminium discs.

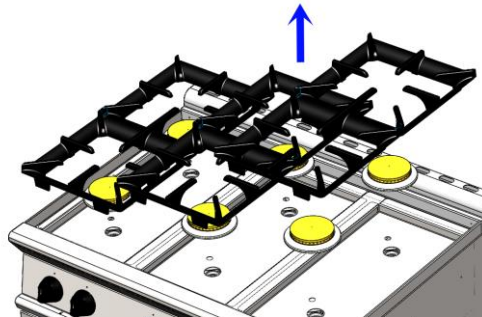

Remove the solid top plates.

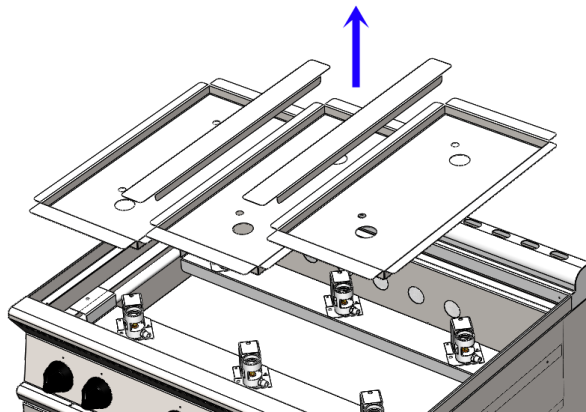

Using a 10mm spanner or nut runner remove burner injector. Replace with injector from conversion kit. Replace solid top plates, aluminium burner plates and burner caps.

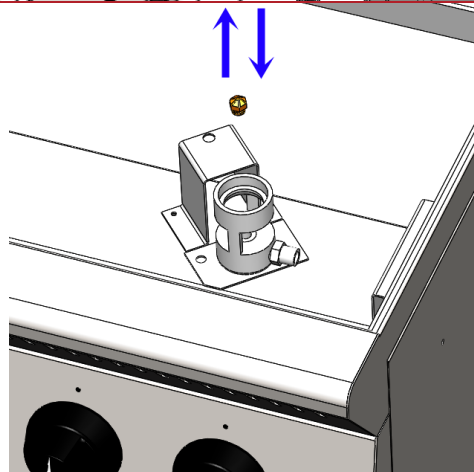

Remove the tap knobs to allow the fascia to be removed.

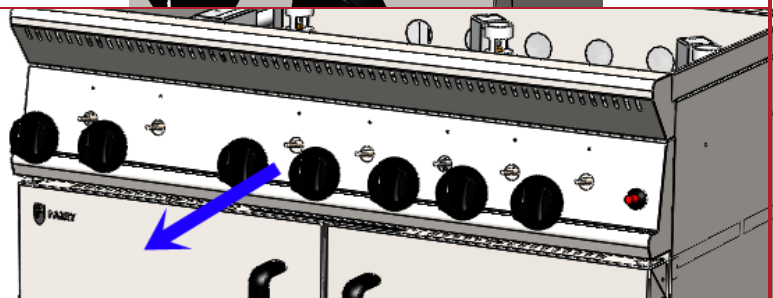



Conversion Procedure

<p>Open doors and underneath the fascia unscrew the 2 x securing screws. Pull fascia away from the bottom. Disconnect HT lead from piezo.</p>	
<p>Remove low rate screws in hob tap bodies and replace with low rate screw from the conversion kit.</p> <p>Replace low rate screw in oven thermostat body from the conversion kit.</p>	
<p>Converting the oven burner.</p> <p>Remove shelves and bottom tray.</p>	
<p>Unscrew the 15mm nut on the jet that goes into the burner.</p> <p>Unwind anti-clockwise the jet out of the burner.</p>	



Conversion Procedure

Replace jet with the jet for the required gas.

Refit gas pipe and tighten up the 15mm nut.

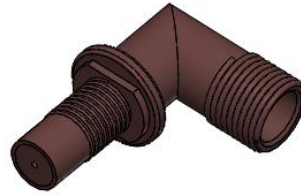

Connect the unit back to the gas supply and test for gas soundness. Replace the facia and knobs accordingly.



When conversion is complete addix new data label and gas type label supplied with the conversion kit, detailing type of gas and pressure.



Technical Information

Per Hob Burner

GAS		OPERATING PRESSURE	TOTAL HEAT INPUT
NATURAL	G20	20mb / 8" W.G.	5.557 KW = 18959 Btu/h
PROPANE	G31	37mb / 14.8" W.G.	4.351 KW = 14846 Btu/h

GAS RATE		M ³ /HR	FT ³ /HR	LB/HR	KG/HR
NATURAL	G20	0.588 M ³ /HR	20.765 FT ³ /HR		
PROPANE	G31	0.178 M ³ /HR	6.286 FT ³ /HR	0.691 LB/HR	0.313 KG/HR

BURNER LOW RATE		FLOWRATE	HEAT INPUT
NATURAL	G20	0.126 M ³ /HR	1.176 KW
PROPANE	G31	0.029 M ³ /HR	0.700 KW

Per Oven Burner

GAS		OPERATING PRESSURE	TOTAL HEAT INPUT
NATURAL	G20	20mb / 8" W.G.	6.804 KW = 23215 Btu/h
PROPANE	G31	37mb / 14.8" W.G.	8.140 KW = 27774 Btu/h

GAS RATE		M ³ /HR	FT ³ /HR	LB/HR	KG/HR
NATURAL	G20	0.720 M ³ /HR	25.427 FT ³ /HR		
PROPANE	G31	0.333 M ³ /HR	11.760 FT ³ /HR	1.292 LB/HR	0.586 KG/HR

Total Unit

GAS		OPERATING PRESSURE	TOTAL HEAT INPUT
NATURAL	G20	20mb / 8" W.G.	40.144 KW = 136970 Btu/h
PROPANE	G31	37mb / 14.8" W.G.	34.173 KW = 116599 Btu/h

GAS RATE		M ³ /HR	FT ³ /HR	LB/HR	KG/HR
NATURAL	G20	4.248 M ³ /HR	150.017 FT ³ /HR		
PROPANE	G31	1.398 M ³ /HR	49.370 FT ³ /HR	5.425 LB/HR	2.460 KG/HR
AIR FLOW RATE FOR COMBUSTION 20m ³ /HR			44.52 FT ³ /HR		

BURNER LOW RATE		FLOWRATE	HEAT INPUT
NATURAL	G20	0.758 M ³ /HR	7.070 KW
PROPANE	G31	0.175 M ³ /HR	4.200 KW



Replacement Parts

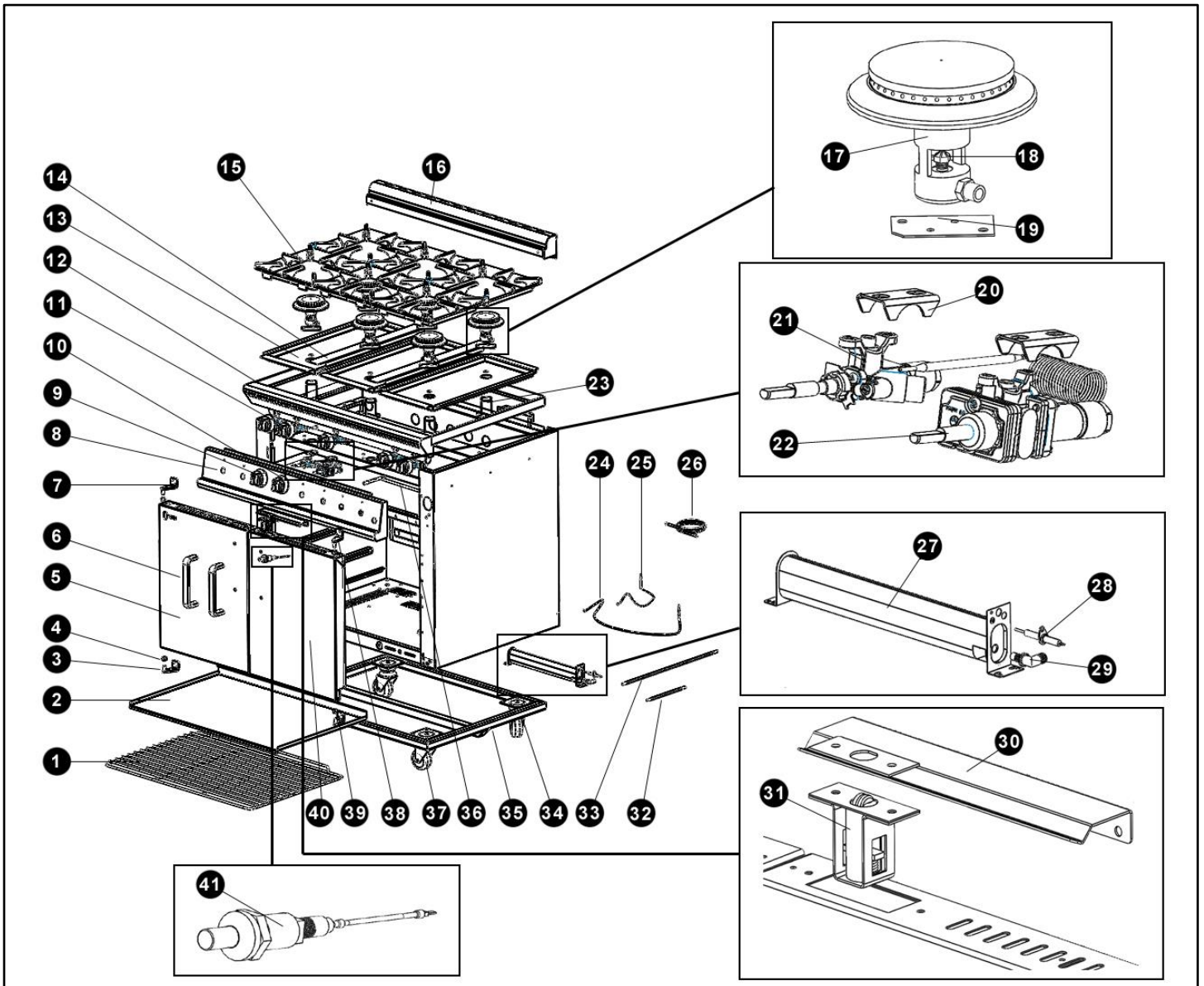



Replacement Parts

Item Number	Components	Part Code
1	Shelf	TRWC00750
2	*Tray	*No Code
3	Bottom LH Hinge	ULT6BOHINGEBL
4	Hinge Bush	ULTHINGEBUSH
5	LH Door	
6	Door Handle	GB6HANDLE
7	Top LH Hinge	ULT6BOHINGETL
8	*Fascia	*No Code
9	Control Knob Hob	ULTKNOB5A
10	Control Knob Oven	ULTKNOB4A
11	Gas Rail	GB6GASRAIL
12	*Top Surround	*No Code
13	*Top Cover	*No Code
14	*Middle Cover	*No Code
15	Pan Support	CASTP6BO
16	*Flue Cover	*No Code
17	Hob Burner Complete with Injector Carriage	BURNRHOB
18	Hob Injector (Nat) Hob Injector (LPG)	HOBINJECT185 HOBINJECT105
19	*Injector Carriage Plate	*No Code
20	Saddle Bracket	SADDLEBKT
21	Hob Gas Valve	GASTAPHOB
21a	Hob Bypass Screw (Nat) Hob Bypass Screw (LPG)	COPBPS-70 COPBPS-50
22	Oven Valve	OVENVALVE
22a	Oven Bypass Screw (Nat) Oven Bypass Screw (LPG)	COPBPS-85 COPBPS-50
23	*Thermocouple Bracket	*No Code
24	600mm Thermocouple	THCP600ISP
25	320mm Thermocouple	THCP320ISP
25a	Thermocouple Extension Lead	THERMCOUPEXT
26	1830mm HT Lead	CABLHT1830
26a	High Temperature Sleeving (Length mm)	SBSY00GAS
27	Oven Burner	BURNROVEN
28	Electrode	ELECT7013
29	Oven Injector (Nat) Oven Injector (LPG)	INJECT220 INJECT150
30	Door Keep	LCPDOORKEEP
31	Ball Catch Assembly	



Replacement Parts

Item Number	Components	Part Code
32	Flexi Tube 200mm	FLEXT200X8
33	Flexi Tube 500mm	FLEXT500X8
34	75mm Swivel Castor	CASTOR75SW
35	*Chassis	*No Code
35a	Leg Plate	LEGPLATE
36	Oven Gas Pipe	OVENPIPE1
37	75mm Swivel Braked Castor	CASTOR75BR
38	Top RH Hinge	ULT6BOHINGETR
39	Bottom RH Hinge	ULT6BOHINGEBR
40	RH Door	
41	Piezo + Link Lead	GB6PPIEZO
	Adjuster Boss for Castors	ADJM12
	Door Seal	SEALPGS10
	Door Seal Dart Clips (18 Per unit)	CLIP01180
	Flue Joining Gasket	GASK07013
	Oven Insulation Set	RKWL07013



Disposal and Recycling

The packaging should be disposed of in accordance with the regulations in force.



Warranty Information

The manufacturer's warranty is only valid in the UK mainland. Northern Ireland, Western Isles, Inner Hebrides and Islands are parts only warranty. Please be aware that the warranty starts from the date of purchase from Parry and not the sale or installation date of the equipment.

To be eligible for a 2 year warranty, products must be serviced at least once within the first 12 months of purchase.

All service calls will be carried out between 8am and 5pm, Monday to Friday.

Your warranty is invalid if your equipment has not been installed in accordance with the manufacturer's instructions. The misuse, alteration or unauthorised repairs of the equipment will also invalidate the warranty.

During the warranty period it is at Parry's discretion whether to repair or replace the equipment. The warranty only applies if the equipment has been used in a professional manner following the manufacturer's instructions and maintenance guidelines.

The warranty covers defects in the material and component failure only. We are not liable for trading loss, loss of perishable items, water damage or loss due to injury or fire damage.

Please ensure you have referred to the manufacturer's instruction before placing a warranty call.

Contact our warranty department on **01332 875544** for technical assistance.

Please have your model number ready before calling.







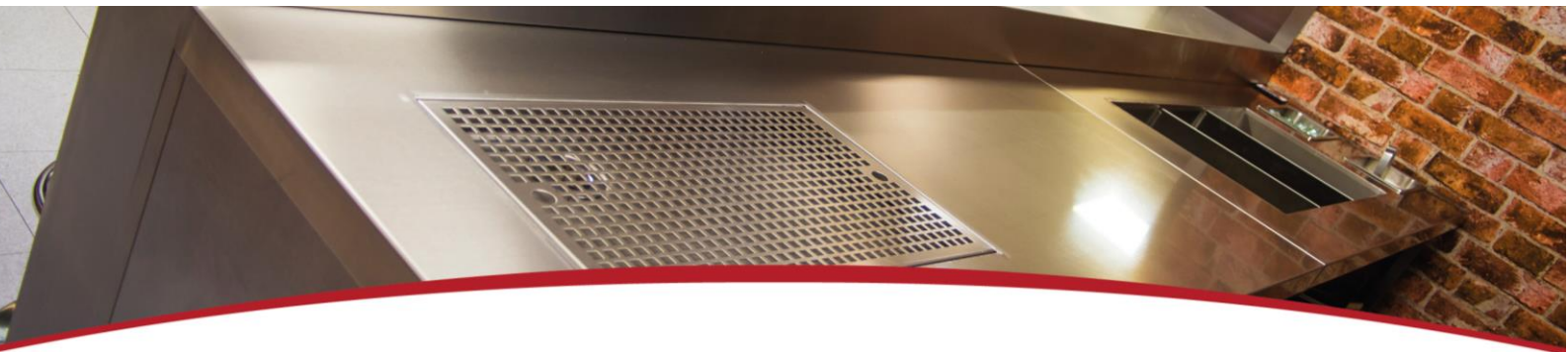

All warranty requests must be submitted to warranty@parry.co.uk.



Failure to pay any warranty charges will result in your warranty being put on hold until the bill has been settled. Any issues regarding the raised charges should be put in writing to our warranty department for further investigation.

Register your product by visiting our website www.parry.co.uk



Not covered under warranty

-  Fault due to incorrect installation, poor maintenance or equipment abuse.
-  Resetting of equipment or circuit breakers.
-  Faulty electrics – e.g. customer's plug socket, plug, wiring, junction box fault, wrong fuse.
-  Products must be serviced within the first 12 months to be eligible for the 2 year warranty
-  Product not covered by warranty if combustible materials have been used, e.g. plastic trays.
-  Foil used on racks, blockages and lime scale issues.
-  Failure to grant access for pre-arranged service call.
-  Equipment that has been set up or used incorrectly e.g. dishwasher detergents, levelling and setting up of doors on a six burner cooker.
-  Excessive carbon build-up on griddle plates or overuse of lava rock on chargrills. (Recommended use by Parry no more than 2kg.)

-  Appliances that have been installed in mobile trailers are covered by parts only warranty for 24 months.
-  Extraction canopies are sold with parts only warranty on the fans and speed controllers for 24 months. If parts are found to be faulty through lack of cleaning of the extraction canopy the part will be chargeable. The equipment should be installed by a competent person. The equipment installer needs to know the design, performance and the capacity of the ventilation system, so they can ensure adequate ventilation.
-  All of the above points are not covered by warranty and any costs incurred, because of the above, will be forwarded to the parties responsible for placing the call.