



DISHWASHER USER MANUAL



Models
DK775 DN975

Safety Instructions

- Position on a flat, stable surface.
- A service agent/qualified technician should carry out installation and any repairs if required. Do not remove any components on this product.
- Consult Local and National Standards to comply with the following:
 - Health and Safety at Work Legislation
 - BS EN Codes of Practice
 - Fire Precautions
 - IEE Wiring Regulations
 - Building Regulations
- DO NOT immerse the appliance in water.
- Always switch off and disconnect the power supply to the appliance when not in use.
- Not suitable for outdoor use.
- Keep all packaging away from children. Dispose of the packaging in accordance to the regulations of local authorities.
- Children should be supervised to ensure they do not play with, or operate the Glass Washer
- The function of this Dishwasher is the washing of Plates, Glasses and similar ONLY.
- Do not use cleaning agents that contain Chlorine, Bleach or Hypochlorite
- Only use commercial grade detergents and rinse aids in your Glass Washer
- Wear the correct personal protective equipment when handling chemicals and observe all safety notes
- Damage to the Dishwasher caused by lime scale or poor water quality will NOT be covered by the manufacturers warranty – fitting of a water softener is recommended
- The installer and user are responsible for ensuring the installation and operation of this Dishwasher
- Ensure the base of the unit is never submerged or standing in water when operating the Dishwasher
- Do not use electrical extension lead(s) to supply power to your Dishwasher
- If the power cord is damaged, it must be replaced by a qualified technician in order to avoid a hazard.
- This appliance can be used by children aged from 8 years and persons with reduced physical, sensory or mental capabilities or lack of experience and knowledge if they have been given supervision or instruction concerning use of the appliance in a safe way and if they understand the hazards involved. Children shall not play with the appliance. Cleaning and user maintenance shall not be made by children without supervision.
- Ambient temperature where the machine is operated should be between (+5 °C / +40 °C).
- If the appliance is fed with hot supply water, water inlet temperature must not exceed maximum + 50 °C.
- The appliance is designed to operate with softened water at a Clark water hardness level of (<9 Degree Clark). Excess calcium in water supply may damage moving parts of the appliance and decrease washing performance of the appliance regularly.
- If the appliance has to be operated continuously, then it should be paused for 1 hour for every 4 hours of operation.
- We recommend Jantex Dishwasher Detergent (CF976) and Rinse Aid (CF977)
- BUFFALO recommend that this appliance should be periodically tested (at least annually) by a Competent Person. Testing should include, but not be limited to: Visual Inspection, Polarity Test, Earth Continuity, Insulation Continuity and Functional Testing.
- Buffalo recommend that this product is connected to a circuit protected by an appropriate RCD (Residual Current Device).

Introduction

Please take a few moments to carefully read through this manual.

Correct maintenance and operation of this machine will provide the best possible performance from your Buffalo product.

Contents

The following is included:

Buffalo Dishwasher
Plate Rack, Glass Rack and Cutlery Rach
Water Inlet Hose
Water Drain Hose
Instruction Manual

BUFFALO prides itself on quality and service, ensuring that at the time of packaging the contents are supplied fully functional and free of damage. Should you find any damage as a result of transit, please contact your BUFFALO dealer immediately.

Technical Data

Model	DK775	DN975
Voltage	230V 50Hz	400V 50Hz
Rating (kW)	6.6kW Max	9.6kW Max
Washing/Boiler Tank Capacity	23ltr/7ltr	23ltr/7ltr
Number of Programs	5	5
Program Times (Seconds)	50/100/130/150/190	50/100/130/150/190
Washing Water Temperature	55°C	55°C
Rinsing Water Temperature (Max)	85°C	85°C
Water Inlet Connection	3/4"	3/4"
Water Inlet Pressure Max (Bar/Temp)	2-4 Bar / 50°C	2-4 Bar / 50°C
Heat Power (Washing/Rinsing)	2 / 6kW	2 / 9kW
Dirty Water Discharge Connection	3/4" (Ø 28mm)	3/4" (Ø 28mm)
Weight	93kg	93kg
Dimensions (H(open)xWxD) mm	1480(1960)x700x785	1480(1960)x700x785
Protection Class	IPX5	IPX5
Rack Dimension mm	500x500	500x500
Loading Height mm	445	445

Device Dimensions

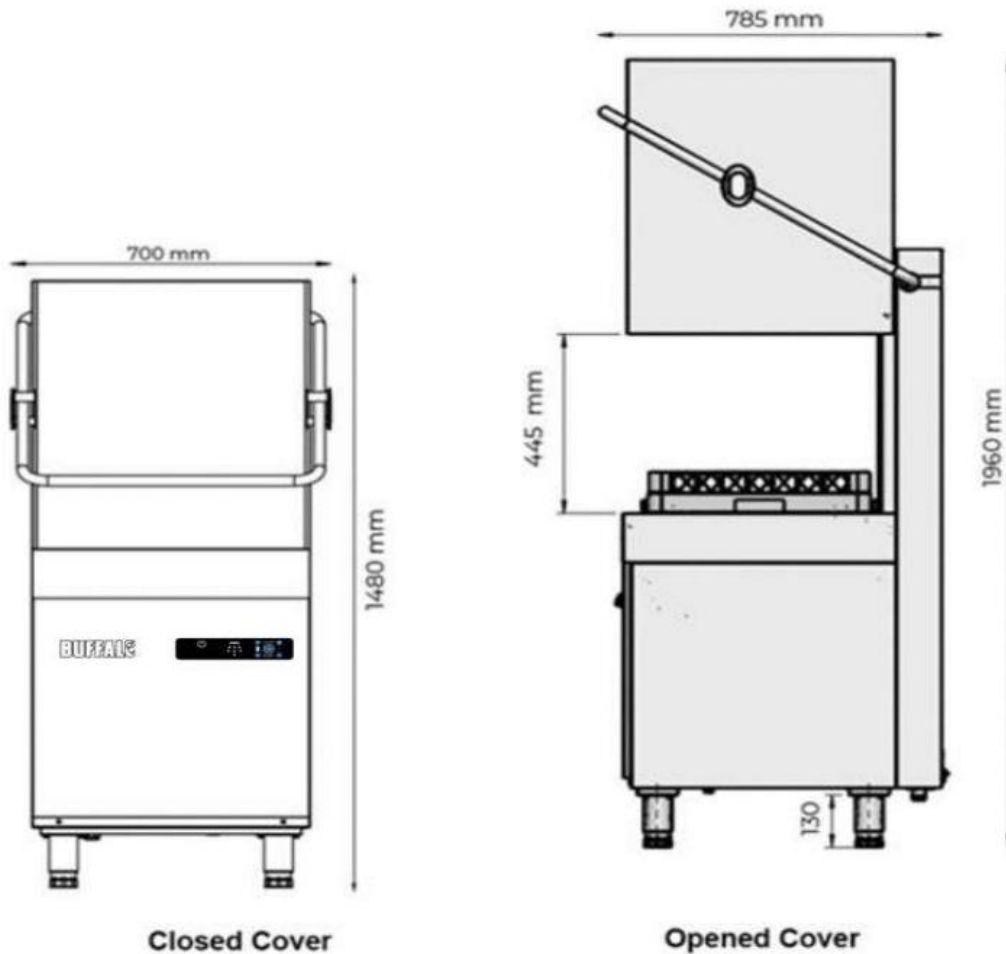

Installation - Water Connection

Note - Plumbing connections must be made in such way that will allow the machine to be removed for service and cleaning.

1. Connect the hose supplied with the machine to the inlet at the rear of the machine and the $\frac{3}{4}$ " NPT fitting on the water supply line.
2. Check the water inlet pressure is between 2-4 bar (29-58 psi) (not static). If it is more a PRV (pressure reducing valve) must be installed. If it is less a booster pump will be required
3. Washing performance of the appliance depends on external conditions such as water inlet temperature, pressure, hardness and chemicals used (detergent, rinse aid). To increase the service life and washing performance of the appliance, supply water should be below 9 degree Clark. Otherwise a water softening device should be fitted.
4. Water inlet temperature: 4-50°C.

Caution! Any damage resulting from the use of hard water will not be the manufacturer's or distributor's liability, and voids the product warranty.

Use of Detergent and Rinse Aid in the Dishwasher

Your Buffalo Dishwasher has a detergent pump and a rinse-aid pump for use with containers of **NON-FOAMING** liquid detergent.

1. Insert the hoses of the pumps in the correct chemical container (clear tube for detergent, blue tube for rinse aid).
2. Ensure both of the hoses are at the bottom of the containers of the chemicals.

Note - The chemicals to be used should be suitable for Dishwashers. The detergent shall be the **No Foam type**, suitable for Glass Washing machines.

Note - We recommend that you use detergent and rinse aid from the same manufacturer. Jantex Dishwash detergent (CF976) & Jantex Dishwasher rinse aid (CF977) are recommended.

Note - When the machine is installed from new or when the containers are allowed to run dry, the full priming takes place after 8-10 washing-rinsing cycles.

Detergent Pump

Detergent amount required is dependent on soil and water hardness. Dosage can be regulated via the control panel. (See Changing Parameters section of this manual)

Rinse Aid Pump

Rinse Aid amount required is dependent on water hardness. Dosage can be regulated via the control panel. (See Changing Parameters section of this manual)

Note – We recommend the use of a Water Softener to reduce limescale which can damage your machine

Priming Detergent and Rinse Aid

When using for the first time or if the detergent / rinse aid is allowed to run dry, detergent and rinse aid hoses will be full with air. To prime detergent and rinse aid hoses use the following instructions -

Note: Please use this option after the machine has reached the required temperature values.



Press and hold the settings icon for 3 seconds 



Enter the password "1" by using "up" and "down" buttons. Hold  for 3 seconds to confirm

This will take you to the "Detergent filling screen". To start priming detergent press start/pause button (Hold 3 sec). Detergent pump will start to run.

You can see the amount of detergent that you prime to the machine on the screen.

Press start/pause icon again when you want to stop priming the detergent



To prime the rinse aid press and hold the settings icon for 3 seconds 

This will take you to the "Rinse Aid filling screen". To start priming Rinse Aid press start/pause button (Hold 3 sec). Rinse Aid pump will start to run.

You can see the amount of Rinse Aid that you prime to the machine on the screen.

Press start/pause icon again when you want to stop priming the Rinse Aid



Washing and Rinsing Water Temperatures

Water temperatures can be adjusted. During production, the appliance is set to the following temperature values. The temperature should not be set higher than these temperatures.

Models:	DK775 & DN975 Pass Through Dishwasher
Rinsing Water Temp.(Boiler)	85°C
Washing Water Temp.(Tank)	55°C

Operation of the Appliance

Getting to know the appliance: To understand the information in the user manual correctly, the main parts of the appliance should be known, see below.

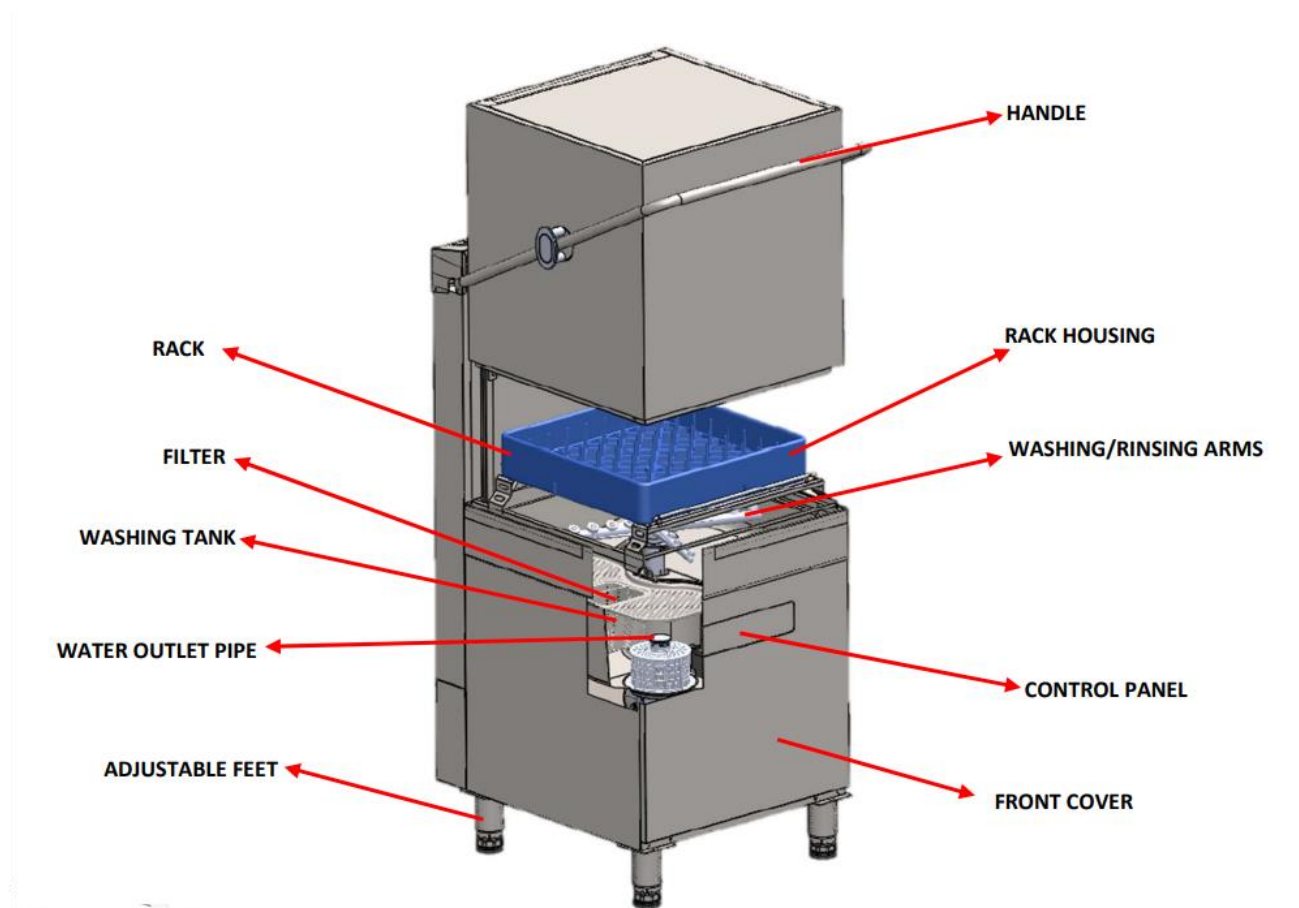

Operation

Control Panel

Before starting the appliance, familiarise operators with the control buttons and signal items on the front panel. In addition operators should be familiar with the location of power and water cut-off switches.

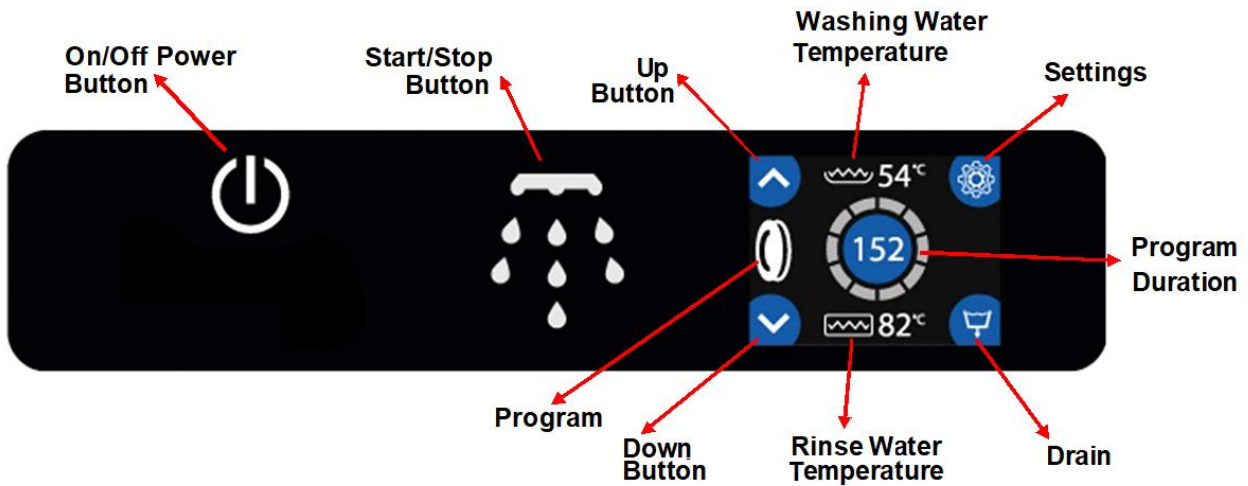

Starting the Appliance

Make sure that the electricity, water and drain installations are complete. Wait for the "On/Off switch" on the front panel to light, then keep it pressed for 3 seconds. The LCD screen will switch on



The machine will start to take water automatically. Heating starts automatically when the set amount of water has entered the boiler

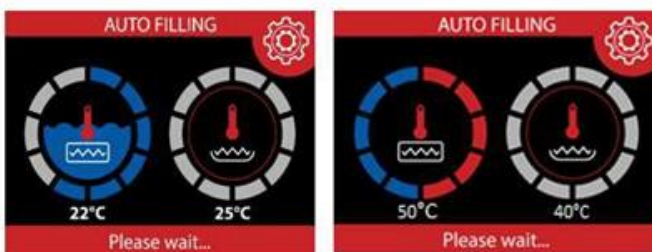

When the boiler gets to 60C, heated water is sent to the washing tank. This process continues until the washing tank is fully filled.



After the washing tank is fully filled, the machine waits for the boiler and washing tank set temperatures to be reached. When the Boiler water temperature reaches 85C and the Tank water temperature reaches 55C the machine is ready for washing.

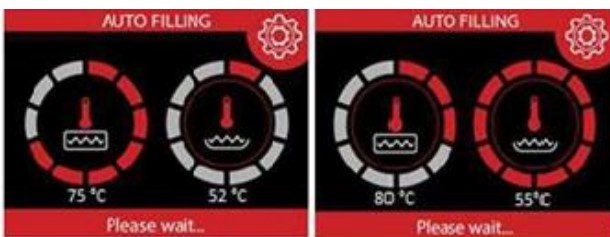



Note: The washing process will not start until the Washing tank and Boiler reach the set temperature

Note: In order for the water to heat up faster during the process the machine door must be closed

Accessing the Settings Menu

Press and hold the settings icon for 3 seconds 





Use  up and  down buttons to enter '2'. You will see the password screen



Hold  3 seconds to confirm

Changing Parameters

Access the settings Menu. Choose the program that you want to change. Use settings icons:   to change the parameters



Hold  for 3 seconds to confirm changes

Note: If the changes made are to be valid in all programs, the same setting values must be entered for each program

By using the settings menu you can change the following –

P01 Tank Temperature. Wash Tank temperature can be adjusted. The setting is made separately for each program

P02 Boiler Temperature. Boiler Tank temperature can be adjusted. The setting is made separately for each program



P03 Washing Time. Washing time can be adjusted. The setting is made separately for each program

P05 Waiting Time after Washing. Waiting time after washing can be adjusted. The setting is made separately for each program. This is the waiting period after washing but before rinsing to prevent droplets from the washing process falling on the glasses after the rinsing process has started.

P08 Getting Detergent Time. Detergent time can be adjusted. The setting is made separately for each program. The Detergent pump is on a timer. The longer the time set the more Detergent will enter the machine

P09 Getting Rinse Aid Time. Rinse Aid time can be adjusted. The setting is made separately for each program. The Rinse Aid pump is on a timer. The longer the time set the more Rinse Aid will enter the machine

P11 Dirtiness Counter. Counts the number of washes until the washing tank water should be changed.

When count reached the  icon will appear on screen. When the water has been drained  will disappear from screen

P15 Tank Preheating. Set to 0 washing cycle can be started without the boiler and wash temperatures being at the set temperature. Set to 1 and the washing cycle will only start when pre set boiler and wash temperatures are reached.

P17 Start by Door/Hood. Set to 0 to start touch the drop icon on the control screen. Set to 1 and the washing cycle will start when the door/Hood is closed

Preparation for Use

At initial start up of the appliance, wait for the supplied water to warm up. After the water temperature reaches 'Factory Settings' warning sound will ring. Appliance is designed to function efficiently when proper temperatures are reached. If the temperatures are decreased, wait for the appliance to reach temperature before starting a new wash cycle.

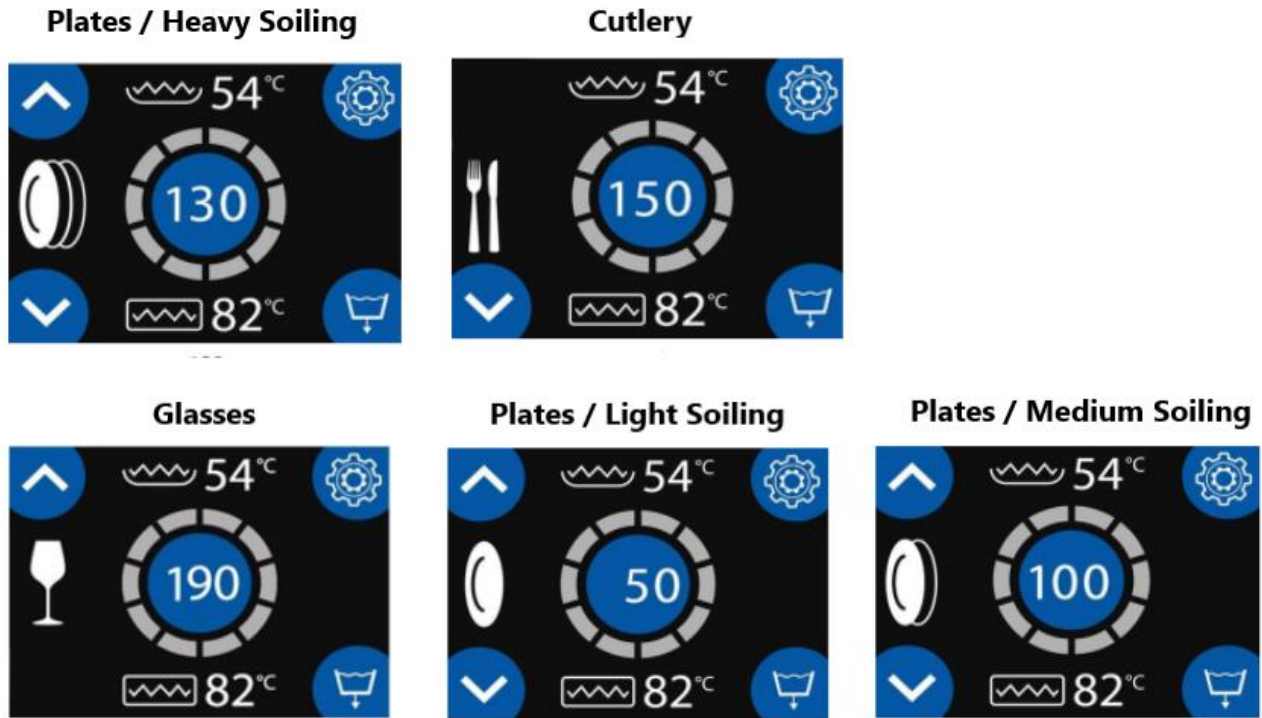

Wash Programs



Starting a Wash Cycle

Open the hood, place the first basket inside the machine, check that the arms rotate freely.



Select the appropriate Washing program depending on type of dishes and degree of soiling with program selection buttons:  .

The washing process is started by pressing the washing start button . The program time will start counting down on the LCD display. When the washing program is finished, the machine starts rinsing. If the cabinet door is opened during the washing process (if no button is pressed), the washing machine process will stop. When the door is closed again, the program will continue from where it left off. When the washing process is finished, the machine beeps.

Draining

Excess water generated during the operation of the machine will be automatically removed via the drain.

At the end of each day the door should be left open to drain and dry. Before the machine is turned off at the end of the day the boiler water must be completely drained.



Models without Drain Pump (Drain by Gravity)

Turn off the appliance from the control panel. Open the appliance's door and remove the drain plug in the tank. Now, machine will start draining. Once draining is complete, re-place the drain plug.

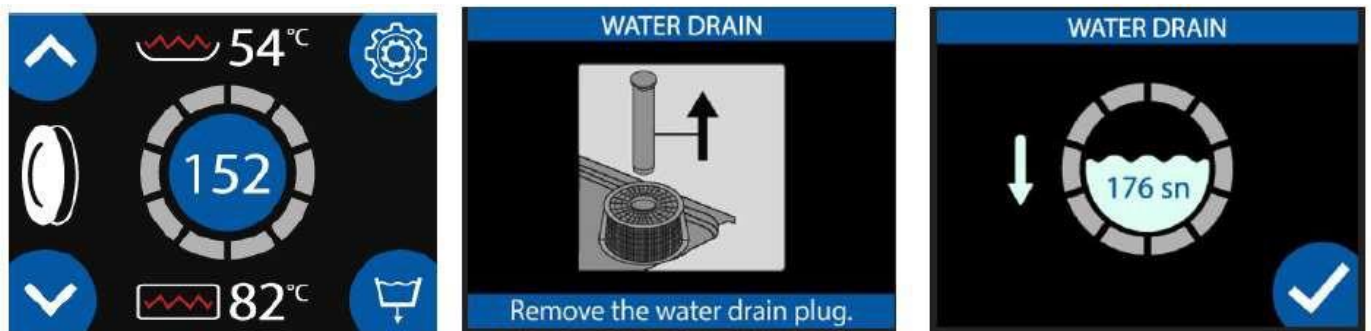
Models With a Drain Pump



In each operation, the drain system is automatically activated when the rinsing cycle is started.

Before turning off the unit at the end of the day the unit should be drained. Press the  drain symbol and remove the plug. Press  to confirm and drainage operation will start automatically. After discharge time is finished, the drain pump will stop automatically. After finish the drain process press the 'On/Off' switch to the turn off the machine.

Note: Once draining is complete, it is recommended to disconnect mains water and electrical supply, and clean the appliance as described. For a more hygienic operation, leave the appliance door open after the draining process to ensure that boiler is naturally dried.

Cleaning and Maintenance

Periodical Maintenance and Clean-up

Maintenance should be carried out by trained personnel in accordance with the safety instructions.

Daily Maintenance

- Washing arms should be disconnected and any debris should be removed using water and a nylon brush
- Debris remaining in the washing tank should be removed.
- Suction filter should be disconnected and cleaned with water.
- The inside of the tank should be cleaned up with a sponge or cloth and plenty of water.
- After cleaning operation is finished suction filter, water outlet pipe, scrap filters and washing and rinsing arms should be reinstalled.

Periodical Maintenance

Periodic maintenance should be carried out by the user at least once in a month, this should be done when the machine is ready for operation and before the glasses are set up in the machine.

- Descale the machine by adding descaler to the washing tank and follow descaler instructions (which may vary depending on brand).
- After descaling water within the machine should be drained and unit should be refilled with fresh water. Run the machine for 5 cycles then drain and refill again with fresh water. The machine will now be ready for operation.
- If the device is not used for long period of time, you must drain the water left inside the boiler. For this purpose, let the water drain out after opening the tap (boiler tank tap) at the lower part of the unit. Leaving water standing inside the unit for long period when not in use may harm your machine.

Note

- Never use cleaning chemicals containing bleaching agents, chlorine or hypochloride.
- Never use steel sponge or wire brush for cleaning purposes.
- Do not use pressurized water to clean inner and outer surfaces of the appliance.
- Before cleaning the interior of the glasswasher, first carefully remove from the wash tank any parts that may cause injury during cleaning, such as broken glass.
- Wipe clean the interior of the glasswasher. Once wastes and particles are removed, re-place the washing/rinsing arms and filters.
- Clean the outer surface of the glasswasher with a damp cloth.
- After drying, clean with a stainless-steel approved sanitizer (e.g. Jantex FS431)

Electrical Circuit Diagram

DK775

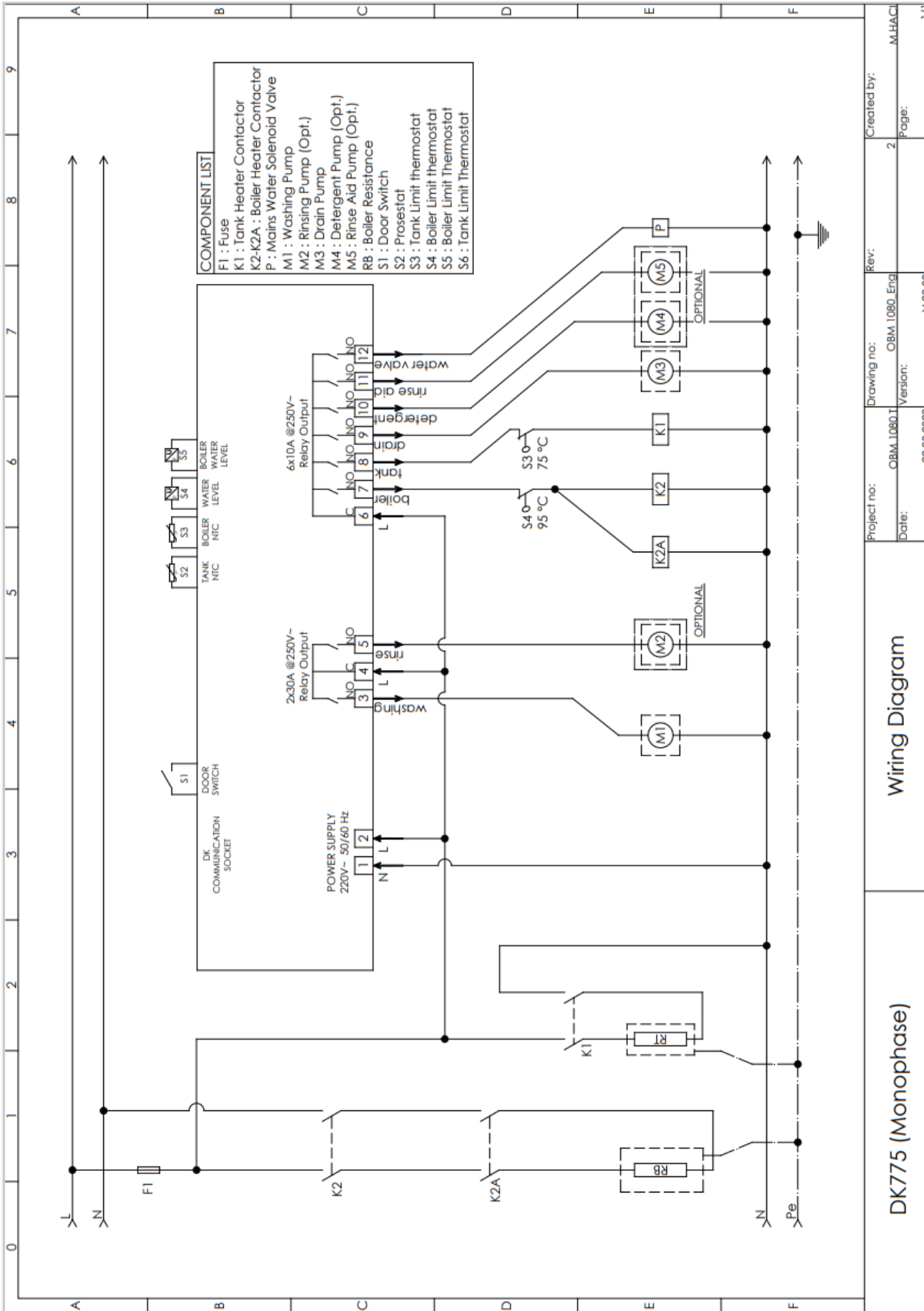

DK775 (Monophase)

Wiring Diagram

Project no: OBM.1080.1
 Date: 22.03.2024
 Drawing no: OBM.1080.ENG
 Version: v 2.0.00
 Rev: 2
 Created by: M.HACI
 Page: 1/1

DN975

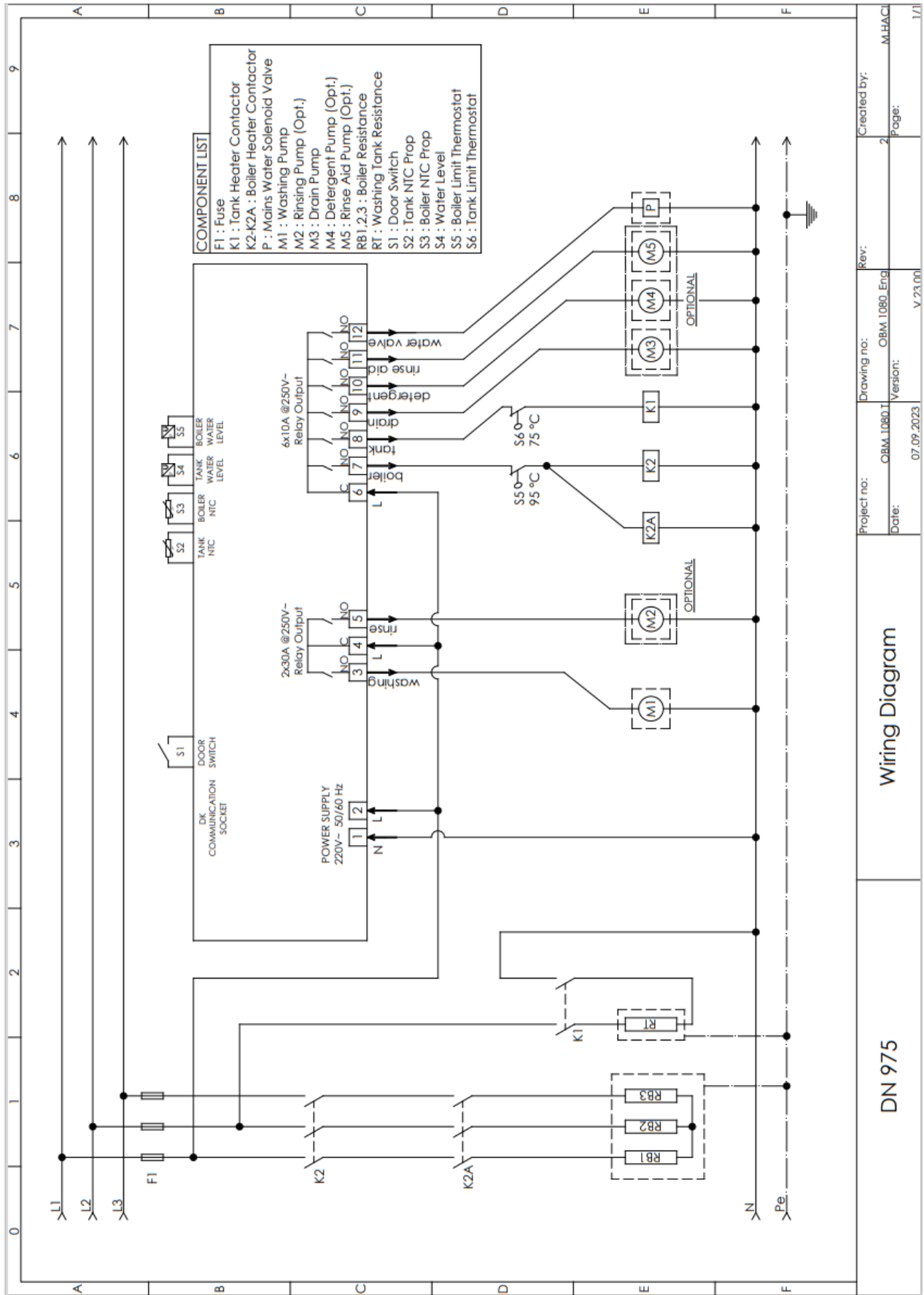

Project no: OBM.1080.T		Drawing no: OBM.1080.Eng		Rev: 2		Created by: M.HACI	
Date: 07.09.2023		Version: V.23.00		Page: 2		1/1	
Wiring Diagram				DN 975			

Trouble Shooting

Fault	Possible Cause	Solution
Unit does not switch on	No electrical supply to the appliance.	Check mains water and electrical connection is in place and active
Unit does not run when the start button is pressed	Hood not closed	Ensure that the Hood is securely closed
	Controller Faulty	Contact your Buffalo Distributor
Unit is not heating the wash water	Boiler water level low	Check water is turned on
	Inlet water to hot/cold	Ensure inlet water temperature is between 5 and 50°C
	Washing tank resistor faulty due to scale	Descale the unit
	The thermostat in the reservoir is faulty.	Contact your Buffalo Distributor
Unit is not heating the boiler water	Boiler resistor faulty due to scale	Descale the unit
	Boiler thermostat may be faulty.	Contact your Buffalo Distributor
	Boiler resistor may be faulty	Contact your Buffalo Distributor
Poor washing performance	Detergent Rinse Aid low	Check the detergent and rinse aid chemicals. If empty replace
	Jet nozzles on washing arms blocked	Clean jet nozzles on washing/rinsing arms
	Filters blocked	Clean the filters.
	Water level low	Make sure that water supply is on
	Dishes being loaded without emptying	Remove any left-overs / debris on dishes before loading the basket.
	Dishes may require pre-washing if excessively soiled.	Pre Wash Dishes
	White marks on dishes can be caused by hard water	Contact your Buffalo distributor for details on using the necessary water softener.
Appliance cannot be switched off	Unit Faulty	Isolate the mains electrical supply, and contact your Buffalo distributor for technical service
Appliance does not drain	Filters blocked	Clean the filters.
	Drain hose and /or drain vent blocked	Unblock drain hose and/or drain vent
	Drain Pump not activated (if fitted)	Follow instructions in 'Model with a Drain pump section of this manual
Water intake is slow	Water supply is not open	Ensure water supply is open
	Low Water pressure	Water pressure should be 2-4 bars. If pressure is low, a booster pump will be required.
	Water Outlet Nozzles on washing arms are blocked	Clean water outlet nozzles on the washing arms.
	Water inlet hose blocked or bent	Check water inlet hose
	Low pressure due to the pressure reducer valve on the water supply line,	Water pressure regulator can be adjusted / removed by component engineer

Electrical Wiring

Connection to a suitable power supply should only be carried out by a qualified and competent electrical engineer.

DK775 is supplied wired for installation to a single phase 230v 32A power supply.

DN975 is supplied wired for installation to a 3 phase 400v 16A power supply

This appliance must be earthed.



For safety reasons your machine MUST be bonded to adjacent metalwork or earthed so that it is at the same potential (i.e. voltage).

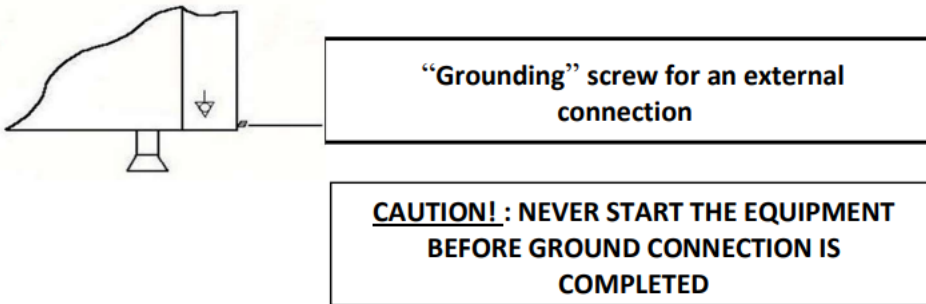

Electrical isolation points must be kept clear of any obstructions. In the event of any emergency disconnection being required they must be readily accessible.

Buffalo recommend that this product is connected to a circuit protected by an appropriate RCD (Residual Current Device).

Compliance

The WEEE logo on this product or its documentation indicates that the product must not be disposed of as household waste. To help prevent possible harm to human health and/or the environment, the product must be disposed of in an approved and environmentally safe recycling process. For further information on how to dispose of this product correctly, contact the product supplier, or the local authority responsible for waste disposal in your area.



DECLARATION OF CONFORMITY

- Conformiteitsverklaring • Déclaration de conformité • Konformitätserklärung • Dichiarazione di conformità •
• Declaración de conformidad

Equipment Type • Uitrustingstype • Type d'équipement • Gerätetyp • Tipo di apparecchiatura • Tipo de equipo	Model • Modèle • Modell • Modello • Modelo
Digital Pass Through Dishwasher - 6.6kW Digital Pass Through Dishwasher - 9.7kW 3ph	DK775(-E) DN975(-E)
Application of Territory Legislation & Council Directives(s) Toepassing van Europese Richtlijn(en) • Application de la/des directive(s) du Conseil • Anwendbare EU-Richtlinie(n) • Applicazione delle Direttive • Aplicación de la(s) directiva(s) del consejo	Low Voltage Directive (LVD) - 2014/35/EU Electrical Equipment (Safety) Regulations 2016 EN 60335-1:2012 +A11:2014 +A13:2017 +A1:2019 +A14:2019 +A2:2019 +A15:2021 EN 60335-2-58:2005 +A1:2008 +A11:2010 +A2:2015 +A12:2016 IEC 60335-1:2010 +A1:2013 +A2:2016 IEC 60335-2-58:2017 EN 62233:2008 Electro-Magnetic Compatibility (EMC) Directive 2014/30/EU - recast of 2004/108/EC Electromagnetic Compatibility Regulations 2016 (S.I. 2016/1091) EN 55014-1:2021 EN 55014-2:2021 IEC 60335-1: 2020 Restriction of Hazardous Substances Directive (RoHS) 2015/863 amending Annex II to Directive 2011/65/EU Restriction of the Use of Certain Hazardous Substances in Electrical and Electronic Equipment Regulations 2012 (S.I. 2012/3032)
Producer Name • Naam fabrikant • Nom du producteur • Name des Herstellers • Nome del produttore • Nombre del fabricante	Buffalo

I, the undersigned, hereby declare that the equipment specified above conforms to the above Territory Legislation, Directive(s) and Standard(s).

Ik, de ondergetekende, verklaar hierbij dat de hierboven gespecificeerde uitrusting goedgekeurd is volgens de bovenstaande Richtlijn(en) en Standaard(en).

Je soussigné, confirme la conformité de l'équipement cité dans la présente à la / aux Directive(s) et Norme(s) ci-dessus
Ich, der/die Unterzeichnende, erkläre hiermit, dass das oben angegebene Gerät der/den oben angeführten Richtlinie(n) und Norm(en) entspricht.

Il sottoscritto dichiara che l'apparecchiatura di sopra specificata è conforme alle Direttive e agli Standard sopra riportati.

El abajo firmante declara por la presente que el equipo arriba especificado está en conformidad con la(s) directiva(s) y estándar(es) arriba mencionadas.



Date • Data • Date • Datum • Data • Fecha

Signature • Handtekening • Signature • Unterschrift Firma • Firma

Full Name • Volledige naam • Nom et prénom • Vollständiger Name • Nome completo • Nombre completo

Position • Functie • Fonction • Position • Qualifica • Posición

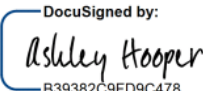
Producer Address • Adres fabrikant • Adresse du producteur • Anschrift des Herstellers • Indirizzo del produttore • Dirección del fabricante

11th Dec 2023	
DocuSigned by:  B39382C9FD9C478...	DocuSigned by:  D352874F7FAB460...
Ashley Hooper	Eoghan Donnellan
Group Head of Product Quality & Compliance	Commercial Manager/ Importer
Fourth Way, Avonmouth, Bristol, BS11 8TB United Kingdom	Unit 9003, Blarney Business Park, Blarney, Co. Cork Ireland



DK775_DN975_v2

