



KitchenAid

Cordless Hand Blender 5KHBBV53 5KHBBV83



EN	Use & Care manual	2	NO	Håndbok for bruk og vedlikehold	115
DE	Gebrauchs- und Pflegeanleitung	15	FI	Käyttö- ja huolto-opas	127
FR	Manuel d'utilisation et d'entretien	29	DA	Vejledning til anvendelse og vedligehold	139
IT	Manuale d'uso e manutenzione	43	IS	Notenda & Meðhöndlunar handbók	151
NL	Gebruiks- en onderhoudshandleiding	55	RU	Руководство по эксплуатации и уходу	163
ES	Manual de uso y cuidado	67	PL	Instrukcja obsługi i konserwacji	175
PT	Manual de utilização e manutenção	79	CS	Návod k použití a údržbě	187
EL	Εγχειρίδιο Χρήσης και Φροντίδας	91	TR	Kullanım ve Bakım kılavuzu	199
SV	Handbok för skötsel och användning	103	AR	دليل الاستخدام والعناية	1





PARTS AND FEATURES

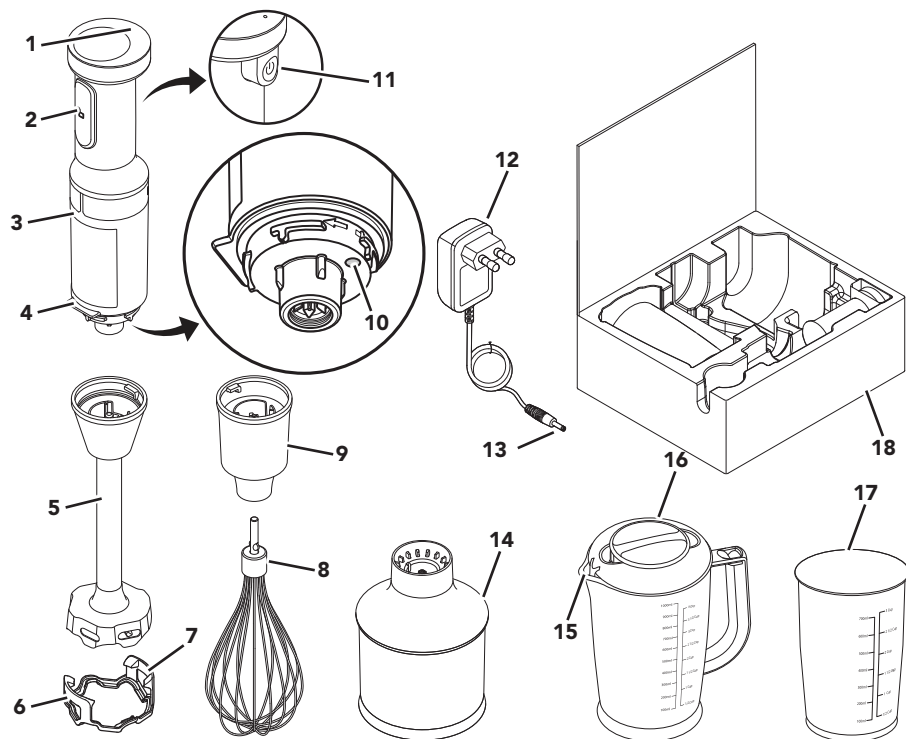

- | | | | |
|---|---|----|---|
| 1 | Battery Status Indicator | 10 | Charging Port |
| 2 | Palm Switch | 11 | Variable Speed Controller |
| 3 | Motor Body | 12 | Charger Adapter |
| 4 | Edge: Helps to avoid roll over of the Cordless Hand Blender. | 13 | Charger Adapter Pin |
| 5 | Blending Arm 20.3 cm (8 inch) | 14 | Chopper Attachment |
| 6 | Pan Guard: Use the Pan Guard to avoid damage to cookware while using Cordless Hand Blender. | 15 | Pour Spout |
| 7 | Mounting Clips | 16 | 1 Litre (4 Cup) BPA-free Blender Pitcher with Lid |
| 8 | Whisk | 17 | 700 ml (3 Cup) BPA-free Blender Jar with Lid |
| 9 | Whisk Adapter | 18 | Storage Case |

ACCESSORY GUIDE

Parts	Included with model	
Pan Guard (6)	5KHBBV53	5KHBBV83
Whisk attachment (8 & 9)		5KHBBV83
Chopper Attachment (14)		5KHBBV83
1 Litre (4 Cup) BPA-free Blender Pitcher with Lid (16)		5KHBBV83
700 ml (3 Cup) BPA-free Blender Jar with Lid (17)	5KHBBV53	



PRODUCT SAFETY

ENGLISH

Your safety and the safety of others are very important.

We have provided many important safety messages in this manual and on your appliance. Always read and obey all safety messages.



This is the safety alert symbol.

This symbol alerts you to potential hazards that can kill or hurt you and others.

All safety messages will follow the safety alert symbol and either the word “DANGER” or “WARNING.” These words mean:

! DANGER

You can be killed or seriously injured if you don't immediately follow instructions.

! WARNING

You can be killed or seriously injured if you don't follow instructions.

All safety messages will tell you what the potential hazard is, tell you how to reduce the chance of injury, and tell you what can happen if the instructions are not followed.

IMPORTANT SAFEGUARDS

When using electrical appliances, basic safety precautions should always be followed, including the following:

1. Read all instructions. Misuse of appliance may result in personal injury.
2. To protect against risk of electrical shock, do not put the Base of Cordless Hand Blender, Charger Adapter, cord, or electrical plug in water or other liquid.
3. This appliance is not intended for use by persons (including children) with reduced physical, sensory, or mental capabilities, or lack of experience or knowledge, unless they are closely supervised and instructed concerning use of the appliance by a person responsible for their safety.
4. Children should be supervised to ensure that they do not play with the appliance.
5. This appliance should not be used by children and care should be taken when used near children.
6. Turn the appliance OFF, then unplug from the outlet if it is left unattended and before assembling, disassembling, cleaning or when not in use. To unplug the charger, grasp the plug and pull from the outlet. Never pull from the power cord.
7. If the supply cord is damaged, it must be replaced by a special cord or assembly available from the manufacturer or its service agent.
8. European Union only: This appliance shall not be used by children, Keep the appliance and its cord out of reach of children. Cleaning and user maintenance shall not be made by children without supervision.
9. European Union only: Appliances can be used by persons with reduced physical, sensory or mental capabilities or lack of experience and knowledge if they have been given supervision or instruction concerning use of the appliance in a safe way and understand the hazards involved. Children shall not play with the appliance.



PRODUCT SAFETY

10. Avoid contacting moving parts.
11. Do not operate any appliance with a damaged cord or plug, or after the appliance malfunctions, or is dropped or damaged in any manner. Return appliance to the nearest Authorised Service Facility for examination, repair, or electrical or mechanical adjustment.
12. The use of attachments not recommended or sold by the manufacturer may cause fire, electric shock, or injury.
13. Do not use the appliance outdoors.
14. Do not let cord hang over edge of table or counter.
15. Do not let cord contact hot surfaces, including the stove.
16. Keeps hands and utensils out of the container while blending to prevent the possibility of severe injury to persons or damage to the unit. A scraper may be used but must be used only when the unit is not running.
17. Blades are sharp. Handle Carefully. Care should be taken when handling the sharp cutting blades, emptying the bowl and during cleaning.
18. When mixing liquids, especially hot liquids, use a tall container or make small quantities at a time to reduce spillage.
19. To reduce the risk of injury, never place cutting blade on Base without first putting bowl properly in place.
20. Be certain cover is securely locked in place before operating the Cordless Food Chopper.
21. Do not use an extension cord. Plug charger directly into an electric outlet.
22. **WARNING:** For the purposes of recharging the battery, only use the detachable supply unit provided with this appliance. Do not attempt to use this charger with any other product. Likewise, do not attempt to charge this appliance with any other charger.
23. The appliance contains batteries that are non-replaceable.
24. Do not incinerate this appliance even if it is severely damaged. The batteries can explode in a fire.
25. Be careful if hot liquid is poured into the Food Chopper as it can be ejected out of the appliance due to a sudden steaming.
26. Keep hands and utensils away from the cutting blade while chopping food to reduce the risk of severe injury to person, or damage to the Cordless Hand Blender. A scraper may be used, but only when the Cordless Hand Blender is not running.
27. Refer to the “Care and Cleaning” section for instructions on cleaning the surfaces in contact with food.
28. This appliance is intended to be used in household and similar applications such as:
 - staff kitchen areas in shops, offices, or other working environments;
 - farmhouses;
 - by clients in hotels, motels and other residential type environments;
 - bed and breakfast type environments.

SAVE THESE INSTRUCTIONS





PRODUCT SAFETY

ELECTRICAL REQUIREMENTS

Charger Adapter:**Input:** 220-240 V~ 50-60 Hz**Cordless Hand Blender:****Voltage:** 8 Volts**NOTE:** If the plug does not fit in the outlet, contact a qualified electrician. Do not modify the plug in any way.

LITHIUM-ION BATTERY OPERATED PRODUCT DISPOSAL

Always dispose the battery operated products according to federal, state, and local regulations. Contact a recycling agency in your area for recycling locations.

ELECTRICAL EQUIPMENT WASTE DISPOSAL

Disposal of packing material

The packing material is recyclable and is marked with the recycle symbol (♻️). The various parts of the packing must therefore be disposed of responsibly and in full compliance with local authority regulations governing waste disposal.

Scrapping the product

- This appliance is marked in compliance with European Directive 2012/19/EU, Waste Electrical and Electronic Equipment (WEEE).

- By ensuring this product is disposed of correctly, you will help prevent potential negative consequences for the environment and human health,

which could otherwise be caused by inappropriate waste handling of this product.



- The symbol  on the product or on the accompanying documentation indicates that it should not be treated as domestic waste but must be taken to an appropriate collection centre for the recycling of electrical and electronic equipment.

For more detailed information about treatment, recovery and recycling of this product, please contact your local city office, your household waste disposal service or the shop where you purchased the product.

DECLARATION OF CONFORMITY

This appliance has been designed, constructed and distributed in compliance with the safety requirements of EC Directives: 2014/35/EU, 2014/30/EU, 2009/125/EC and 2011/65/EU (RoHS Directive).



GETTING STARTED

BEFORE FIRST USE

1. Charge the battery until the Battery Status Indicator turns solid green.
2. Clean all the parts and accessories (see "Care and Cleaning" section).
3. Remove all packaging materials, if present.

BATTERY STATUS

Battery status	% Battery status	Full charge*	Quick charge**
Green	30% to 100%	25 bowls soups, 7 batches	1 Smoothie or 1 Soup
Yellow	15% to 30% (Consider charging)		
Red	Lower than 15% (Need to charge soon)		

*Full Charge:

The Cordless Hand Blender will be fully charged in 2 hours. The Battery Status Indicator pulses when it charges and turns to solid green with a full charge. The Cordless Hand Blender will make 25 bowls of soup (354 ml), 7 batches on a full charge based on 12 ounces of tomato basil soup when following the recommended battery maintenance.

**Quick Charge:

In 20 minutes, the Cordless Hand Blender will quick charge. The Cordless Hand Blender will run for approximately one smoothie or one soup preparation with one quick charge when following the recommended battery maintenance.

NOTE: Make sure to charge the battery, when the Battery Status Indicator is yellow.

NOTE: It is best to store your Cordless Hand Blender at room temperature.

SUGGESTED FOOD ITEMS – FOOD CHOPPER ATTACHMENT

Food	Quantity	Preparation	Speed	Pulse
Almonds/Nuts	200 gm (7 oz)	Place in whole nuts	High	Quick pulse 15 to 25 times
Beef		Cut into 2 cm (3/4 inch) cubes	High	Quick pulse 10 to 15 times
Carrots		Cut average carrot into quarters	High	Quick pulse 15 to 20 times
Garlic	10 to 12 cloves	Place in whole cloves	High	Quick pulse 10 to 15 times
Onion	100 gm (3.5 oz)	Cut into quarters	High	Quick pulse 6 to 10 times
Parmesan cheese		Cut into 1 cm (3/8 inch) cubes	High	Quick pulse 20 to 30 times

*Processing settings are approximate.

Actual settings may vary depending on quality of food and desired blending results.

TIP: A Quick Pulse is one second On and one second Off operation. Do not operate Blending Arm or Whisk continuously for more than 1 minute.





BATTERY CHARGING

1



In order to charge the battery, twist to unlock and remove the Blending Arm.

2

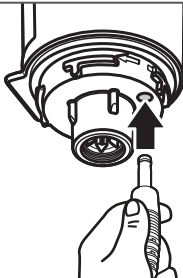

Plug in the Charger Adapter Pin into the Charging Port.

3

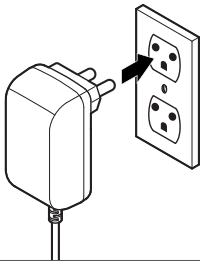

Plug the Charger Adapter into an earthed electrical outlet.

4

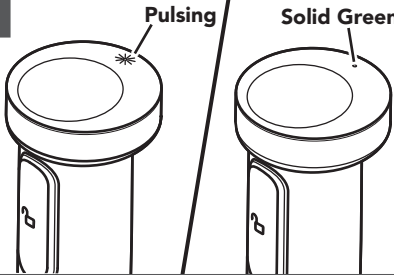

The Battery Status Indicator pulses when it charges. It will be fully charged in 2 hours and the Battery Status Indicator turns solid green.

PRODUCT USAGE

IMPORTANT: Make sure that the Variable Speed Controller is not pressed before attaching or removing parts or accessories.

NOTE: U.S patented removable Pan Guard to help protect your cookware.

1

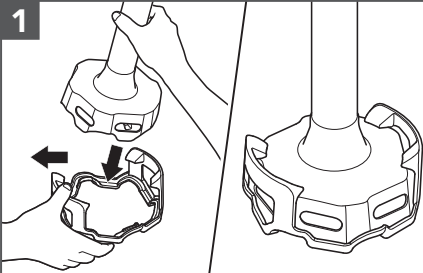

If using a Pan Guard, place it on a flat surface. To insert the Pan Guard, angle the Blending Arm to one side of the mounting clip. Then, gently pull the other mounting clip outward and push down the Blending Arm. Ensure the Mounting Clips are secured into place.





PRODUCT USAGE

2

Blending

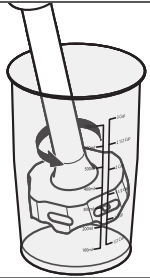

Insert the Cordless Hand Blender into the mixture. Press the Variable Speed Controller and Palm Switch at the same time to start. Use your free hand to cover the top of the Blender Jar for better stability and to avoid splashing.

NOTE: Do not immerse Motor Body into liquids or other mixtures.

3

Drawing up

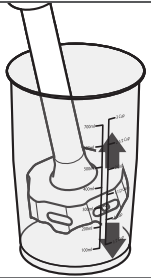

Use the draw up motion with the Cordless Hand Blender to move the ingredients within the jar.

Slowly draw it upwards against the side of the jar. Repeat the process until the ingredients are at the desired consistency.

USING THE CHOPPER ATTACHMENT (INCLUDED WITH 5KHBBV83)

Use to cut and chop beef, onion, garlic, cheese, carrots, nuts, etc.

⚠ WARNING

Cut Hazard
Handle blades carefully.
Failure to do so can result in cuts.

1

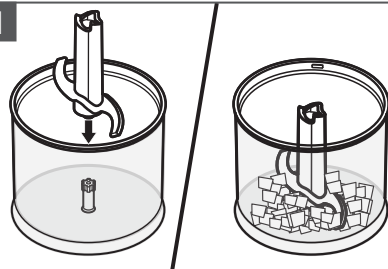

Insert the Chopper blade into Chopper bowl. Add ingredients into the Bowl. For best results, cut the food items into 3/4" (2 cm) pieces.

2

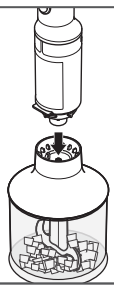

Align the Chopper Attachment with the Motor Body and press together. Do not twist the Motor Body into place.





PRODUCT USAGE

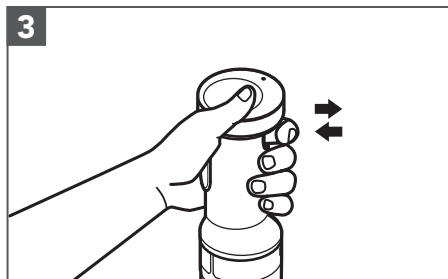

3

Press the Variable Speed Controller and Palm Switch at the same time to start. For best results, "pulse" the power by pressing and releasing the Variable Speed Controller until ingredients reach the desired consistency.

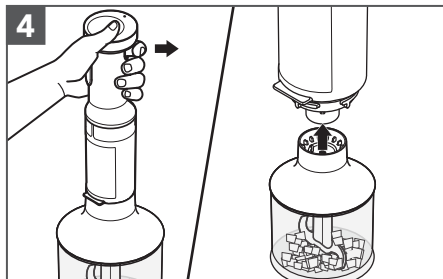

4

When chopping is complete, release the Variable Speed Controller.

USING THE WHISK ATTACHMENT (INCLUDED WITH 5KHBBV83)

Use the Whisk to whip cream, beat egg whites, mix instant puddings, vinaigrettes, mousse, or for making mayonnaise.

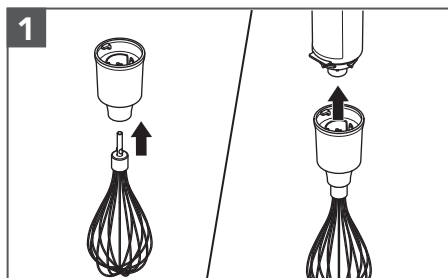

1

Insert the Whisk into the Whisk Adapter until it locks in place. Insert the Whisk accessory into the Motor Body and twist to lock until it clicks.

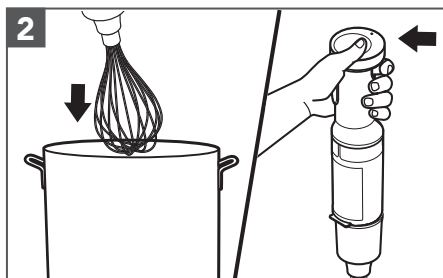

2

Insert the Cordless Hand Blender into the mixture. Press the Variable Speed Controller and Palm Switch at the same time to start.

NOTE: Do not immerse Motor Body into liquids or other mixtures.

TIP: The stainless steel Whisk may scratch or mark non-stick coatings; avoid using the Whisk with non-stick cookware.

NOTE: After whisking is complete, release the Variable Speed Controller; then remove Cordless Hand Blender from mixture.



CARE AND CLEANING

IMPORTANT: Make sure that the Variable Speed Controller is not pressed before attaching or removing parts or accessories.

⚠ WARNING

Cut Hazard
 Handle blades carefully.
 Failure to do so can result in cuts.

1

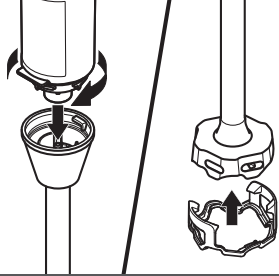

Remove the Blending Arm, Pan Guard, or Whisk accessory before cleaning.

2



Dishwasher safe parts - top rack only:
 Whisk, Pan Guard, Chopper Bowl, Chopper Blade, Chopper Attachment, Whisk Adapter, Blender Arm, Blender Pitcher, Blender Jar, and Lid.

3

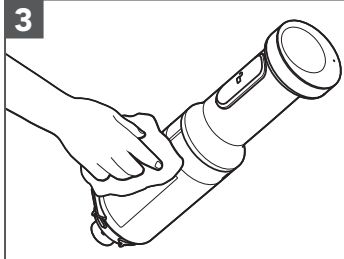

Wipe the Motor Body with a damp cloth. Mild dish soap may be used, but do not use abrasive cleansers.

TIP: You can use the Storage Case of the Cordless Hand Blender to store your product.

For detailed information about the Cordless Hand Blender:

Visit www.kitchenaid.eu for additional instructions with videos, inspiring recipes, and tips on how to use and clean your Cordless Hand Blender.

TROUBLESHOOTING GUIDE

Problem	Solution
If the Cordless Hand Blender fails to start:	Check if the Cordless Hand Blender is charged. Charge the battery when the Battery Status Indicator is red or when the Battery is completely drained.
If the Cordless Hand Blender is not getting charged:	If you have a circuit breaker box, check to make sure that the circuit is closed.
If the Cordless Hand Blender stops while blending:	When overloaded or jammed, it will automatically shut off to prevent motor damage. Divide contents into smaller batches. For certain recipes, adding liquid in the Jar may also reduce the load.
If the problem cannot be corrected:	See the "Terms of KitchenAid Guarantee ("Guarantee")" sections. Do not return the Cordless Hand Blender to the retailer – retailers do not provide service.



TERMS OF KITCHENAID GUARANTEE ("GUARANTEE")

Covering U.K. - Ireland - South Africa - UAE

KitchenAid Europa, Inc., Nijverheidslaan 3, Box 5, 1853 Strombeek-Bever, Belgium ("Guarantor") grants the end-customer, who is a consumer, a Guarantee pursuant to the following terms.

FOR U.K.:

The Guarantee applies in addition to and does not limit or affect the statutory warranty rights of the end-customer against the seller of the product. In summary, the Consumer Rights Act 2015 says products must be as described, fit for purpose and of satisfactory quality. During the expected lifespan of your product your legal rights entitle you to the following:

- Up to 30 days: if your product is faulty, then you can get an immediate refund.
- Up to six months: if your product can't be repaired or replaced, then you're entitled to a full refund, in most cases.
- Up to six years: if your product does not last a reasonable length of time you may be entitled to some money back.

These rights are subject to certain exceptions. For detailed information please visit the Citizens Advice website www.adviceguide.org.uk or call 03454 04 05 06.

FOR IRELAND:

The Guarantee applies in addition to and does not limit or affect the statutory warranty rights of the end-customer against the seller of the product under the European Communities (Certain Aspects of the Sale of Consumer Goods and Associated Guarantees Regulations 2003 (S.I. No. 11/2003)) and other enactments governing the sale of consumer goods.

FOR SOUTH AFRICA:

The Guarantee applies in addition to and does not limit or affect the statutory warranty rights of the end-customer against the seller of the product. In summary, the Consumer Protection Act, 2008 says that products must be: (i) reasonably suitable for the purpose for which they are intended; (ii) in good working order, of good quality and free of any defects; (iii) useable and durable for a reasonable period of time, having regard to the use to which they would normally be put and to all the surrounding circumstances; and (iv) in compliance with any applicable standards or any other public regulations.

During the expected lifespan of your product and where the products are not purchased online, your legal rights will entitle you to the following:

- You will be entitled to a full refund, if you did not have the opportunity to examine the product before delivery and if you rejected delivery of the product on the basis that the type and quality of the product was not as reasonably expected or did not reasonably conform to the material specifications.
- Within 5 business days after delivery: you may rescind your purchase and request a refund, if your purchase resulted from direct marketing.
- Within 10 business days after delivery: you will be entitled to a full refund, if it is found that the product was unsuitable for a particular purpose specifically communicated to you by the Guarantor.
- Within 15 business days after delivery: you will be entitled to a refund if: (i) the product was not delivered to you; or (ii) if you returned the product to the Guarantor.
- Within 6 months after delivery: you will be entitled to a refund or a replacement product, if the product is defective or fails to operate in terms of its specifications.





TERMS OF KITCHENAID GUARANTEE ("GUARANTEE")

Where you have purchased a product online your legal rights will be governed by the Electronic Communications and Transactions Act, 2002 and you will be entitled to the following:

- Within 7 days after conclusion of the transaction or after delivery: you may cancel your purchase without reason and without penalty.
- Within 30 days of the date of cancellation of the transaction: you will be entitled to receive a refund, if you have already made payment.
- You will only be liable for the direct costs of returning the product to the Guarantor.

FOR UAE:

The Guarantee applies in addition to and does not limit or affect the statutory warranty rights of the end-customer against the seller of the product.

1) SCOPE AND TERMS OF THE GUARANTEE

a) The Guarantor grants the Guarantee for the products mentioned under Section 1.b) which a consumer has purchased from a seller or a company of the KitchenAid-Group within the following countries: U.K., Ireland, or South Africa, or the United Arab Emirates (UAE).

b) The Guarantee period depends on the purchased product and is as follows:

5KHBBV53 Two year full guarantee from date of purchase.

5KHBBV83 Two year full guarantee from date of purchase.

c) The Guarantee period commences on the date of purchase, i.e. the date on which a consumer purchased the product from a dealer or a company of the KitchenAid-Group.

d) The Guarantee covers the defect-free nature of the product.

e) The Guarantor shall provide the consumer with the following services under this Guarantee, at the choice of the Guarantor, if a defect occurs during the Guarantee period:

- Repair of the defective product or product part, or
- Replacement of the defective product or product part. If a product is no longer available, the Guarantor is entitled to exchange the product for a product of equal or higher value.

f) If the consumer wishes to make a claim under the Guarantee, the consumer has to contact the country specific KitchenAid service centres or the Guarantor directly at KitchenAid Europa, Inc. Nijverheidslaan 3, Box 5, 1853 Strombeek-Bever, Belgium;

Email-Address U.K.: CONSUMERCARE.UK@kitchenaid.eu

Email-Address IRELAND: CONSUMERCARE.IE@kitchenaid.eu

Toll Free Number U.K. & IRELAND: **00 800 381 040 26**

FOR SOUTH-AFRICA:

Our local KitchenAid Distributor:

KitchenAid Africa
PO Box 52102
V&A Waterfront
Cape Town
8002





TERMS OF KITCHENAID GUARANTEE ("GUARANTEE")

Contact our distributor:

Telephone: +27 21 555 0700

You can contact our Customer Service Centre for Small Domestic Appliances from 8.30 am to 1.00pm and from 1.30 pm to 5.00 pm or write to us at the following address: hello@kitchenaidafrica.com

FOR UAE:

AL GHANDI ELECTRONICS.

POST BOX NO. 9098,

DUBAI, UNITED ARAB EMIRATES

Toll free number: +971 4 2570007

g) The costs of repair, including spare parts, and any postage costs (if applicable) for the delivery of a defect-free product or product part shall be borne by the Guarantor. The Guarantor shall also bear the postage costs for returning the defective product or product part if the Guarantor or the country specific KitchenAid customer service centre requested the return of the defective product or product part. However, the consumer shall bear the costs of appropriate packaging for the return of the defective product or product part.

h) To be able to make a claim under the Guarantee, the consumer must present the receipt or invoice of the purchase of the product.

2) LIMITATIONS OF THE GUARANTEE

a) The Guarantee applies only to products used for private purposes and not for professional or commercial purposes.

b) The Guarantee does not apply in the case of normal wear and tear, improper or abusive use, failure to follow the instructions for use, use of the product at the wrong electrical voltage, installation and operation in violation of the applicable electrical regulations, and use of force (e.g. blows).

c) The Guarantee does not apply if the product has been modified or converted, e.g. conversions from 120 V products to 220-240 V products.

d) The provision of Guarantee services does not extend the Guarantee period, nor does it initiate the commencement of a new Guarantee period. The Guarantee period for installed spare parts ends with the Guarantee period for the entire product.

e) FOR SOUTH-AFRICA & UAE ONLY:

Further or other claims, in particular claims for damages, are excluded unless liability is mandatory by law.

After expiry of the Guarantee period or for products for which the Guarantee does not apply, the KitchenAid customer service centres are still available to the end-customer for questions and information.

Further information is also available on our website:

- For U.K. & Ireland www.kitchenaid.eu

- For South-Africa: www.kitchenaidafrica.com

- For UAE: www.KitchenAid-MEA.com

PRODUCT REGISTRATION

Register your new KitchenAid appliance now: <http://www.kitchenaid.eu/register>



