

## Warewashing



## Glass and dishwashers **ECOMAX+ 415/515**

### Installation and Operation Manual

*(Original Operation Manual)*

EN

---

## Table of Contents

<b>1</b>	<b>Notes on the documentation</b> .....	4
1.1	Application.....	4
1.2	Layout of the documentation.....	4
1.3	Symbols used .....	4
<b>2</b>	<b>Safety instructions and regulations</b> .....	5
2.1	Hazard levels .....	5
2.2	Layout of safety instructions.....	5
2.3	Basic safety instructions .....	5
2.4	Property damage.....	7
<b>3</b>	<b>Product description</b> .....	7
3.1	Intended purpose.....	7
3.2	Designation .....	7
3.3	Technical specifications .....	8
<b>4</b>	<b>Controls</b> .....	8
<b>5</b>	<b>Installation</b> .....	8
5.1	Personnel qualification.....	8
5.2	Special safety instructions.....	9
5.3	Transporting to the installation location.....	9
5.4	Removing the packaging .....	9
5.5	Installing the machine .....	10
5.6	Connecting to the power supply.....	10
5.7	Connecting the water .....	10
5.8	Connecting the drain.....	11
<b>6</b>	<b>Commissioning</b> .....	11
6.1	Personnel qualification.....	11
6.2	Setting the water hardness (optional).....	11
6.3	Filling the salt reservoir (optional).....	11
6.4	Filling chemical hoses.....	12
<b>7</b>	<b>Operation</b> .....	13
7.1	Personnel qualification.....	13
7.2	Special safety instructions.....	13
7.3	Preparations for washing.....	13
7.4	Washing.....	14
7.5	Switch off machine .....	14
7.6	Executing daily cleaning .....	14
7.7	Executing weekly cleaning .....	15
<b>8</b>	<b>Settings</b> .....	15

---

8.1	Overview of operator menu .....	15
8.2	Opening the operator menu .....	15
8.3	Detergent/dosage amount .....	16
8.4	Rinse aid/dosage amount .....	16
8.5	Setting the water hardness (optional).....	16
8.6	Wash cycles .....	17
8.7	Hose filling detergent .....	18
8.8	Hose filling rinse aid .....	18
8.9	External water treatment.....	19
8.10	Temperatures .....	22
8.11	Displaying the temperatures.....	23
<b>9</b>	<b>Display of faults and information</b> .....	<b>24</b>
9.1	Error.....	24
9.2	Information .....	25
<b>10</b>	<b>Troubleshooting guide</b> .....	<b>25</b>
10.1	Poor wash result.....	25
10.2	Other faults.....	26
<b>11</b>	<b>Maintenance</b> .....	<b>26</b>
<b>12</b>	<b>Disposal</b> .....	<b>27</b>
<b>13</b>	<b>Product disclaimer</b> .....	<b>27</b>
<b>14</b>	<b>Conformity</b> .....	<b>28</b>

# ECOMAX+ 415/515

## Notes on the documentation

## 1 Notes on the documentation

### 1.1 Application

This document contains the most important information for the installation and commissioning of the machine by qualified personnel, as well as the information required for day-to-day operation by the operator.

- ▶ Keep the operation manual and all referenced documents in a safe and accessible place.
- ▶ Store the operation manual in a suitable container protected from humidity and dirt deposits.
- ▶ If you sell the machine, pass on the installation and operation manual.

### 1.2 Layout of the documentation

Referenced documents are all instructions that describe the installation, operation, maintenance and repair of the device, as well as additional instructions for all accessories used.









#### For the operator:

- Operating instructions

#### For the specialised tradesman:

- Installation instructions
- Circuit diagram
- Spare Parts Catalogue

### 1.3 Symbols used





Symbol	Meaning
	Warning of hazardous electrical voltage
	Beware of explosion
	Warning of risk of crushing
	Beware of hazardous substances
	Beware of hand injuries
	Beware of slipping
	Beware of hazard area
	Useful additional information and tips

## 2 Safety instructions and regulations

### 2.1 Hazard levels

The hazard level is part of the safety instructions and is denoted by the signal word.

Potential consequences are differentiated by the choice of signal word.

	imminent danger: <b>results in serious</b> physical injury or death
	potentially hazardous situation: <b>can cause serious</b> physical injury or death
	potentially hazardous situation: <b>can cause minor</b> physical injury
	potentially harmful situation: <b>can cause damage</b> to the product or other objects

### 2.2 Layout of safety instructions

These warning notices are depicted with warning symbols and signal words in the corresponding safety colours.





**Nature and source of the hazard**

Explanation on the nature and source of the hazard

- ▶ Measures for averting the hazard
- ▶ Additional measures for averting the hazard, where applicable

### 2.3 Basic safety instructions

#### 2.3.1 Product safety

The machine conforms to state-of-the-art technology and the recognised safety regulations. Nonetheless, hazards may occur.

- ▶ Operate the machine only in compliance with the operation manual.
- ▶ During machine handling, observe the safety instructions and warning notices that precede each action.

All modifications and alterations to the product are reserved for persons authorised by HOBART.

#### 2.3.2 Personnel qualification

- ▶ Observe the regulations on occupational health and safety.
- ▶ Carefully read through the Operation Manual before use.

Activity	User group	Qualification/training
Installation	Qualified personnel	Hobart Service or an electrically qualified person trained by Hobart or a competent person acc. to the German technical regulations for occupational safety (TRBS 1203) trained by Hobart

# ECOMAX+ 415/515

## Safety instructions and regulations

Activity	User group	Qualification/training
	Trainees	Only under professional supervision and examination
Commissioning	Qualified personnel	Hobart Service or an electrically qualified person trained by Hobart or a competent person acc. to the German technical regulations for occupational safety (TRBS 1203) trained by Hobart
	Trainees	Only under professional supervision and examination
Work on electrical system	Qualified personnel	Hobart Service or an electrically qualified person trained by Hobart or a competent person acc. to the German technical regulations for occupational safety (TRBS 1203) trained by Hobart
Operation	Operating personnel and persons over the age of 14	Only under supervision and after instruction by the operator on the basis of the Operation Manual, instructions on dangers
	Handicapped individuals	The suitability must be assessed by the operator on an individual basis
	Persons up to the age of 13	Persons up to the age of 13 are not suited for machine operation
Maintenance, repair	Qualified personnel	Hobart Service or an electrically qualified person trained by Hobart or a competent person acc. to the German technical regulations for occupational safety (TRBS 1203) trained by Hobart
	Trainees	Only under professional supervision and examination

### 2.3.3 Product-specific hazards

#### **Avoid body parts being crushed or knocked:**

- ▶ Observe the instructions on the packaging for storage, lifting or transporting.
- ▶ The machine must be secured against tipping over when set up in a freestanding position.

#### **Avoid risk of explosion:**

- ▶ Do not install machine in a potentially-explosive location.

#### **Avoid electric shock, fire risk:**

- ▶ Do not allow water to flow under live components.
  - Make sure the machine is correctly stored (see frost damage section 2.4).
  - Make sure that the machine does not overflow when being filled.
- ▶ Do not damage the connection cable while unpacking.
- ▶ Have the machine connected to the power supply by qualified personnel.
- ▶ Have all modifications to the machine carried out by qualified personnel.
- ▶ Have additional feed tanks mounted by qualified personnel.
- ▶ Do not operate the machine unsupervised.

#### **Avoid fire risk:**

- ▶ Do not allow water to flow under live components.
  - Make sure the machine is correctly stored (see frost damage section 2.4).
  - Make sure that the machine does not overflow when being filled.
- ▶ Have the machine connected to the power supply by qualified personnel.
- ▶ Have all modifications to the machine carried out by qualified personnel.

#### **Avoid chemical burns, sensitisation of the skin, poisoning:**

- ▶ Wear protective equipment (gloves, safety goggles, protective clothing) when handling chemicals.

- ▶ Use only suitable chemicals. Observe the manufacturer`s data.
- ▶ Have chemical sensor system set by authorised trained service technicians.
- ▶ Do not open the machine during operation, wait for the program to finish.
- ▶ Disconnect the machine from the mains prior to cleaning.
- ▶ For cleaning, wear protective equipment (gloves, safety goggles, protective clothing) when touching parts contaminated by detergent.

**Avoid burns, scalds (to the hands):**

- ▶ Do not open the machine during operation or the evaporation phase, wait for the programme to finish. Otherwise, hot water could spray out.
- ▶ Disconnect the machine from the mains prior to cleaning.

**Avoid slipping:**

Moisture can build up on the machine floor.

- ▶ Provide a floor covering that is guaranteed to be non-slip in case of moisture.

**Residues on the wash ware, hygiene regulations not maintained:**

- ▶ Hygiene regulations must be observed and/or demonstrated in accordance with the national provisions.

### 2.3.4 Additional hazards

Potential hazards caused by operating resources to be used can be found in the enclosed safety datasheets. Workplaces must be signed accordingly.

## 2.4 Property damage

**Avoid frost damage:**

Temperatures below 0°C lead to functional damage.

- ▶ Before storing below 0°C, empty residual water in hoses, tank and boiler.
- ▶ Prior to restart, store the machine at room temperature (min. 15°C) for 24h.

**Avoid water damage:**

- ▶ Do not operate the machine without supervision.
- ▶ Close on-site shut-off valves at the end of operation.

## 3 Product description

### 3.1 Intended purpose

The machine is an item of technical equipment intended solely for commercial dishwashing.

The machine is designed solely for cleaning crockery (porcelain, glass, ceramic, temperature-resistant plastics or stainless steel or similar) from the food industry.

Not for washing:

- Containers that do not come into contact with foodstuffs, such as ashtrays, electric appliances etc.
- Animals or textiles
- Foodstuffs intended for further consumption

### 3.2 Designation

The rating plate is located on the front of the machine. If you have any questions regarding service and parts, quote the serial and DSN No.

### 3.3 Technical specifications

Dimensions (H x W x D)	825 x 600 x 603 mm (415: 705 x 460 x 590)
Water consumption per rinse cycle	2,3 l (415: 2 l)
Power supply	see rating plate
Total loading	see rating plate
Fuse protection	see rating plate
Tank capacity	25 l (415: 10 l)
Loading height	425 mm (415: 315 mm)
Emission sound pressure level $L_{pA}$ (Measurement uncertainty $k_{pA} = 2.5$ dB)	59 dB (A) (415: 57 dB (A))
Weight	60 kg (415: 50 kg)

## 4 Controls

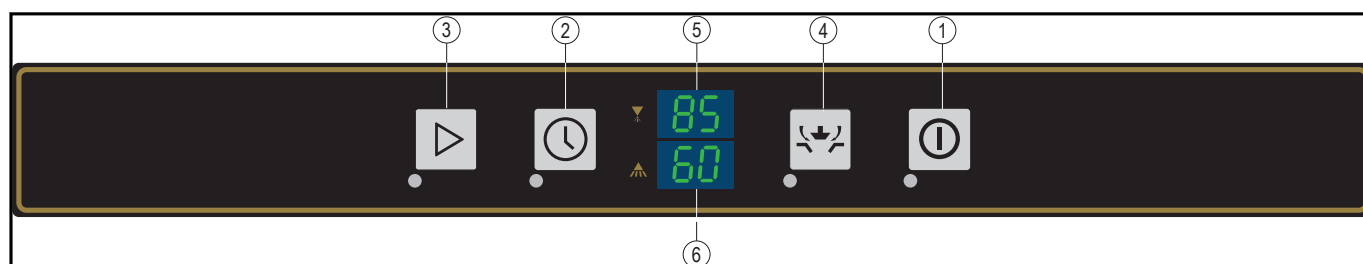

①	ON/Escape key	Pressing this key switches the machine on. In case of operating error or faults, the machine can be switched off immediately without prior pump out by pressing this key. After switch off, however, the machine is not voltage free.
②	Programme selection key	Press the key to choose between 3 different programmes.
③	Programme start key	Press the button to start the washing programme.
④	OFF/Drain key	Pressing and holding (3 seconds) this key activates the automatic self-cleaning cycle and then switches off the machine automatically. On machines with drain pump, the tank is emptied. After switch off, however, the machine is not voltage free.
⑤	Temperature display, rinsing	Standard setting shows the maximum temperature achieved during the last wash programme.
⑥	Temperature display, washing	

## 5 Installation

### 5.1 Personnel qualification

Installation must only be carried out by qualified personnel (see section 2.3.2).



## 5.2 Special safety instructions

### WARNING!



#### Risk of electric shock, fire hazard

Water (frost damage, machine overflow) flowing over live components can cause injury from electric shock or fire.

- ▶ Do not allow water to flow under live components.
- ▶ Make sure the machine is correctly stored (see frost damage section 2.4).
- ▶ Make sure that the machine does not overflow when being filled.

### CAUTION!



#### Risk of being crushed or knocked

When being lifted or transported, the machine can overturn or fall and cause injury.

- ▶ Observe the instructions on the packaging for storage, lifting or transporting.

### WARNING!



#### Risk of explosion

Installing the machine in a potentially explosive location can cause explosion and serious injury from ejected parts.

- ▶ Do not install machine in a potentially-explosive location.

### NOTICE!

#### Frost damage

Temperatures below 0°C during transport/storage cause function impairments.

- ▶ Prior to installation, store the machine at room temperature (min. 15°C) for 24h.

## 5.3 Transporting to the installation location

- ▶ If possible, transport the machine in its packaging and on the pallet.
- ▶ Use suitable transport means (elevating truck, crane etc.).
- ▶ If using a forklift, shim the machine with wooden trusses.

## 5.4 Removing the packaging

### CAUTION!



#### Risk of electric shock, fire hazard

When the machine is unpacked, the connection cable can become damaged and cause injury from electric shock or fire.

- ▶ Do not damage the connection cable while unpacking the machine.
- ▶ Take cable measurement DGUV V3.

- ▶ Remove packaging materials and accessories from the machine.
- ▶ Inspect the machine for possible transport damage.

# ECOMAX+ 415/515

## Installation

### 5.5 Installing the machine

Wall clearance is not required.

- ▶ Align machine horizontally with the aid of a spirit level by turning the adjustable feet until the door handle is flush with the control panel.

#### NOTICE!

##### Property damage

Vapour may escape from the dishwasher door and lead to property damage.

- ▶ Adjacent furniture has to be protected to prevent swelling.

### 5.6 Connecting to the power supply

#### ⚠ WARNING!



##### Risk of electric shock

Failure to connect properly to the power supply can cause mortal danger from electric shock.

- ▶ Have the machine connected to the power supply only by qualified personnel.

**NOTE:** To guarantee the electrical safety of the machine, it must be connected to a protective earthing equipment conductor installed as specified. In addition, the machine must be connected on site to the equipotential bonding connection. The connecting screw (⚡) provided for this purpose is located next to the cable inlet.

These fundamental safety requirements and the professional design of the on-site installation must be verified by a qualified electrician.

Hobart does not accept any liability for damage caused by improper installation! Any applicable local installation instructions must be observed!

The mains cable must be connected via a cut-out device (main switch or accessible plug device).

Modification to an alternative power supply is possible as per the variants on the circuit diagram. Connection diagrams are located adjacent to the connection terminals.

### 5.7 Connecting the water

**NOTE:** The machine must be operated with potable water. For water with an extremely high mineral content, an external demineralisation unit is recommended.

- ▶ If possible, connect to hot water (max. 60°C).

Water hardness:

- Machines without softener: max. 3 °d = 0.5 mmol/l.
- Machines with softener: max. 30 °d = 5.3 mmol/l.

Flow pressure:

- 0,8 - 10 bar.
- > 10 bar: provide pressure reducing valve.

- ▶ Connect the union nut (3/4" thread) of the water supply hose to the site shut off valve.
- ▶ Do not kink or cut the water supply hose.
- ▶ Any required extension must be executed using a suitable pressure hose.

### 5.8 Connecting the drain

- ▶ The connection between machine and site drain must not exceed a max. height of 0.6 m.

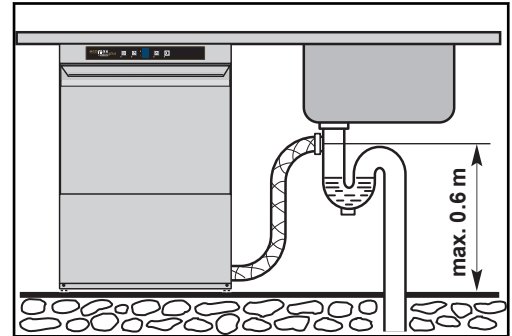

- ▶ Do not lay the drain hose loose on the ground (the hose could become frayed), but fasten it in-situ.
- ▶ Do not kink drain hose.

## 6 Commissioning

### 6.1 Personnel qualification

Commissioning must only be carried out by qualified personnel (see section 5.1).

### 6.2 Setting the water hardness (optional)

**NOTE:** The softener must be set to the existing water hardness (ask at the local water works).

- ▶ Set hardness range according to section 8.5.

### 6.3 Filling the salt reservoir (optional)

#### NOTICE!

##### Property damage

Accidentally filling the salt reservoir with detergent will damage the water softener.

- ▶ Do not fill the salt reservoir with detergent.

- ▶ Open Door.
- ▶ Unscrew the salt reservoir lid and add approx. 1 kg of granular (2-8 mm) regenerating salt (do not use salt tablets).

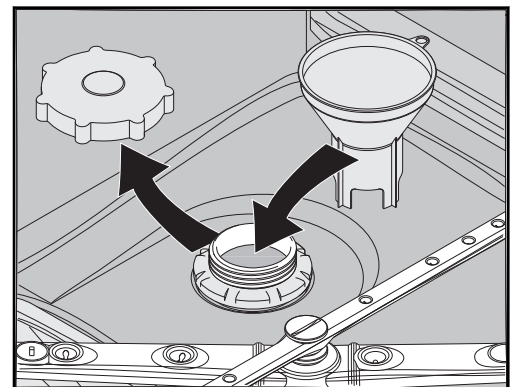

- ▶ Fill up the reservoir with potable water (only at commissioning).
- ▶ Make sure the lid seal is free of dirt and salt.
- ▶ Screw lid back on and tighten.

# ECOMAX+ 415/515

## Commissioning

### NOTICE!

#### Property damage

Salt residues on the tank floor cause corrosion damage.

- ▶ Remove salt residues by hand.
- ▶ On completion of the commissioning procedure, start a wash cycle to remove all traces of salt if necessary.

- ▶ If salt deficiency occurs during operation, the top display shows "SA", the bottom display shows "Lt".



- ▶ To pump out water in the tank, see section 7.5.

## 6.4 Filling chemical hoses



We recommend the use of HOBART Hyline detergent and rinse aid.

**NOTE: Mixing chemicals in the hose when exchanging chemicals can lead to crystallisation and damage to the hoses and dosing units. This is prevented by intermediary rinsing with water (see section 8.7). Failure to comply with this information will invalidate the guarantee and product liability.**

### ⚠ CAUTION!



#### Chemical burns, sensitisation of the skin, poisoning

The use of unsuitable chemicals can cause injury.

- ▶ Use only commercial detergent and rinse aid.
- ▶ Observe the manufacturer's application and safety instructions.

### ⚠ WARNING!



#### Chemical burns, sensitisation of the skin, poisoning

Incorrect handling of detergent or rinse can lead to serious injuries.

- ▶ Wear protective equipment (gloves, safety goggles, protective clothing) when handling chemicals.

### 6.4.1 Provisioning external chemical canisters

#### **Preparing the detergent:**

Suction height of dosing pump: max. 1.5 m.

- ▶ Place suction hose **without** colour marking at the suction valve down to the bottom of the external reservoir.

#### **Preparing the rinse aid:**

Suction height of dosing pump: max. 1.5 m.

- ▶ Place suction hose with **blue** marking at the suction valve down to the bottom of the external reservoir.

## 7 Operation

### 7.1 Personnel qualification

The machine must be operated by instructed personnel (see section 7.1).

### 7.2 Special safety instructions

#### ⚠ CAUTION!



#### Chemical burns, sensitisation of the skin, poisoning, burning

If the Door is opened during operation, vapour can escape and/or wash water can spurt out and cause injury.

- ▶ Do not open the Door during operation, wait for the program to finish.

#### ⚠ WARNING!



#### Danger of slipping

Moisture can build up on the machine floor and cause slipping.

- ▶ Provide a floor covering that is guaranteed to be non-slip in case of moisture.

### 7.3 Preparations for washing

#### 7.3.1 Preparing the machine

- ▶ Check correct position of wash/rinse arms, strainers and if fitted stand pipe.
- ▶ Open site shut-off valve.
- ▶ Turn on main switch or insert the plug.
- ▶ Check level of detergent and rinse aid container.  
(See section 6.4).
- ▶ Close Door.
- ▶ Press the ON/Escape key .



↳ During the filling and heating processes, the key LED flashes. This process can take several minutes.

↳ As soon as the LED is permanently lit, the machine is ready for operation and displays the current wash temperature in the lower display.

#### 7.3.2 Preparing the washware

- ▶ Remove any food residue.
- ▶ Place wash ware face down in the rack.
- ▶ Rinse off wash ware.

# ECOMAX+ 415/515

## Operation

### 7.4 Washing

- ▶ Slide rack into the machine and close the door.
- ▶ Press the programme selection key to show the current programme in the display. Press the key continuously to choose between 3 programmes (P1 = short, P2 = standard, P3 intensive). This is not possible if an error is displayed and while the programme is running.



- ↳ The LED flashes while the programme is running.
- ↳ As soon as the LED lights up permanently, the rinsing process is complete.
- ↳ With the standard setting, the maximum reached temperatures of the completed washing programme are shown in the display.
- ▶ Open the door and remove the rack.
- ▶ Allow the wash ware enough time to dry.

### 7.5 Switch off machine

- ▶ Close the door.
- ▶ Press and hold down the drain button (min. 3 seconds).

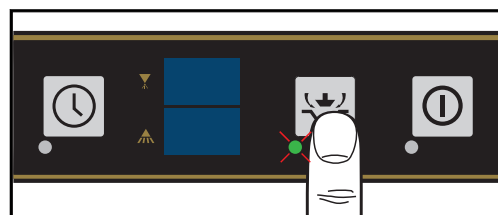

↳ During pump out, the Drain key LED flashes.



During pump out, the machine interior is cleaned automatically. At the end of the programme, the machine switches off automatically. Then remove any coarse food residues.

When the machine has switched off:

- ▶ Turn off main switch or remove the plug.
- ▶ Close on-site shut-off valve.

### 7.6 Executing daily cleaning

#### NOTICE!

##### Property damage

The use of unsuitable agents can cause corrosion or damage to the surfaces.

- ▶ Do not use any chlorine-containing, acidic or metal-containing additives to clean the machine.
- ▶ Do not use metal sponges.

- ▶ Open the door, take out the sieves Rinse under running water. **Make sure that food debris does not enter pump intake!**
- ▶ Clean machine interior.
- ▶ Replace strainer.
- ▶ Leave the door open for ventilation.

## 7.7 Executing weekly cleaning

- ▶ Loosen the fastening screws (A) counter-clockwise.

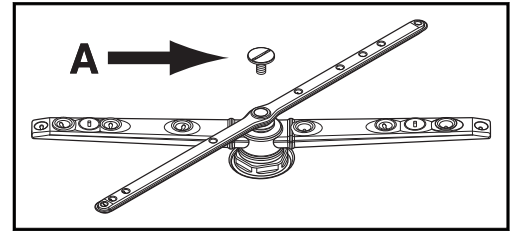

- ▶ Removing and cleaning wash and rinse arms:
- ▶ Replace all parts.

## 8 Settings

### 8.1 Overview of operator menu

Submenu	Function
Detergent/dosage amount	Setting
Rinse aid/dosage amount	Setting
Water hardness	Setting
Wash cycles	Display
Hose filling detergent	For commissioning and replacement of the canister.
Hose filling rinse aid	For commissioning and replacement of the canister.
External water treatment	Resetting Remaining capacity Activate/deactivate Output capacity
Temperatures	Standard / Thermolabel 71°
	Display

### 8.2 Opening the operator menu

**NOTE: Possible only when the machine is switched off.**

- ▶ Open Door.
- ▶ Press the programme start button and the programme selection button at the same time.

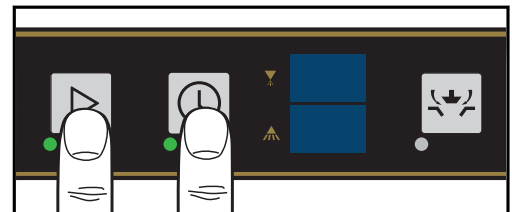

↳ The menu opens, key LEDs illuminate.

↳ The first submenu item "1" appears as soon as the Door is closed.

If the Door is opened again, the display switches off and the entered settings are saved.

The setting sequence described below can therefore be interrupted at any time.

# ECOMAX+ 415/515

## Settings

- ▶ Press the programme start button to scroll through the menus.

### 8.3 Detergent/dosage amount

Only relevant for integrated detergent/dosing units.

- ▶ Top display shows "01"
- ▶ The bottom display shows the current dosage value, default setting: 2.5 g/l
- ▶ To adjust the detergent/dosing quantity, increase using the Standard programme selection button or reduce using the Drain key. The selected value (0-9.5 g/l) will be saved automatically.
- ▶ Make settings according to the recommendations of the detergent supplier.
- ▶ Open the door to escape and exit the menu.

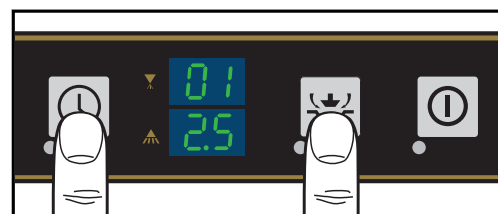

### 8.4 Rinse aid/dosage amount

- ▶ Open menu (see section 8.2).
- ▶ Press the programme start button until the upper display shows „02“.
- ▶ The bottom display shows the current dosage value, default setting: 0.3 g/l.



- ▶ To adjust the rinse aid/dosage quantity, increase using the programme selection button or reduce using the Drain key. The selected value (0-2 g/l) is automatically saved.

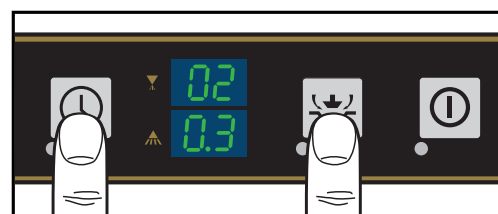

- ▶ Making settings according to the instructions of the rinse aid supplier.
- ▶ Open the door to escape and exit the menu.

### 8.5 Setting the water hardness (optional)

Only relevant with integrated softener.

**NOTE: The softener must be set to the existing water hardness (ask at the local water works).**



- ▶ Open menu (see section 8.2).
- ▶ Press the programme start button until the top display shows "03".



- ▶ The bottom display indicates the set degree of hardness in °d.
- ▶ To adjust the degree of hardness, increase using the programme selection button or reduce using the Drain key. The selected value (1-30) is automatically saved.

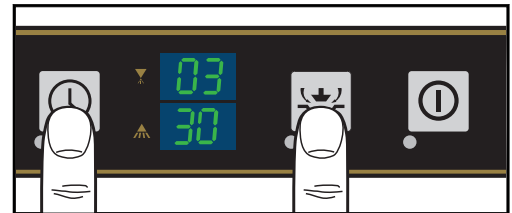

- ▶ Open the door to escape and exit the menu.

## 8.6 Wash cycles

- ▶ Open menu (see section 8.2).
- ▶ Press the programme start button until the top display shows "04".

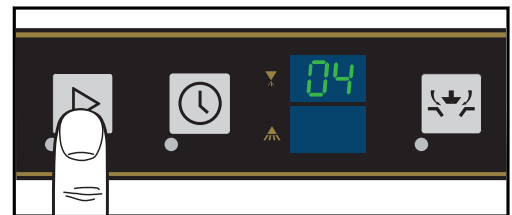

Due to the bottom display being limited to 2 places, the value (max. 6 places) is shown as follows:

e.g. for wash programmes 003456.

- ▶ The first two places are displayed by pressing the programme selection button.

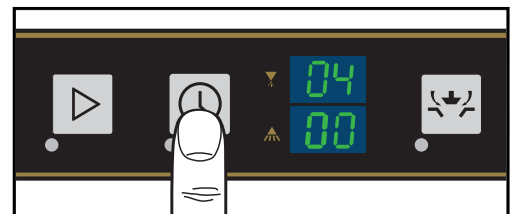

- ▶ The next two places are shown when the programme selection button is pressed.

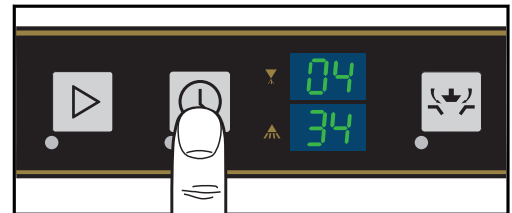

- ▶ The last two places are shown by pressing the programme selection button.

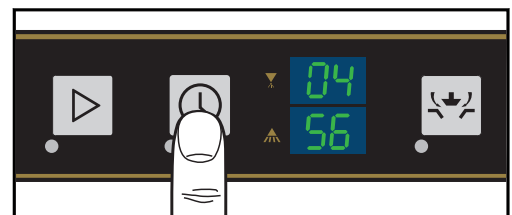

- ▶ If the key is pressed again, the first display reappears, etc.
- ▶ Open the door to escape and exit the menu.

### 8.7 Hose filling detergent

- ▶ Open menu (see section 8.2).
- ▶ Press the programme start button until the top display shows "05".



↳ Bottom display shows "0".

- ▶ Using the programme selection button to set the bottom display to "1".

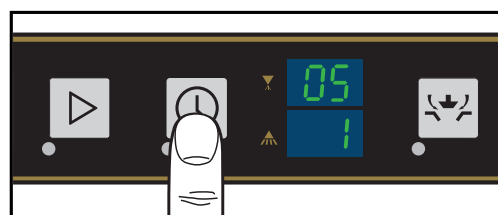

- ▶ Press the Drain key.

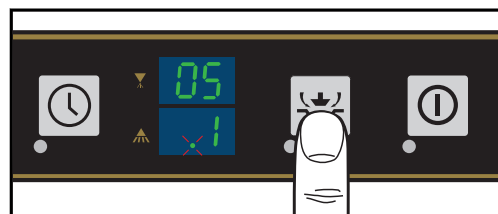

↳ Hose filling starts for approx. 60 seconds.

↳ Item in bottom display flashes.

- ▶ Filling is completed when the flashing stops.
- ▶ Open the door to escape and exit the menu.

There is no need to wait until the end once the filling process has been activated. The filling of the rinse aid hose can also start in parallel.

### 8.8 Hose filling rinse aid

- ▶ Open the Settings menu (see section 8.2).
- ▶ Press the programme start button until the top display shows "06".



↳ Bottom display shows "0".

- ▶ Using the programme selection button to set the bottom display to "1".

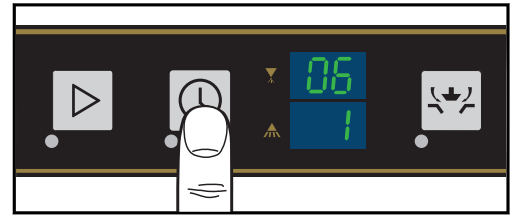

- ▶ Press the Drain key.

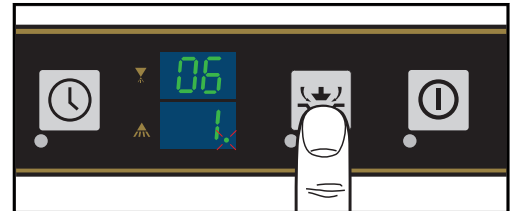

↳ Hose filling starts for approx. 120 seconds.

↳ Item in bottom display flashes.

- ▶ Filling is completed when the flashing stops.
- ▶ Open the door to escape and exit the menu.

## 8.9 External water treatment

Relevant only when activated (see section 8.9.3)

This can be used to monitor the capacity of an external water treatment or a pre-filter on the basis of the calculated water flow.

### 8.9.1 Resetting

Reset the remaining capacity to the output capacity value.

- ▶ Open menu (see section 8.2).
- ▶ Press the programme start button until the top display shows "07".

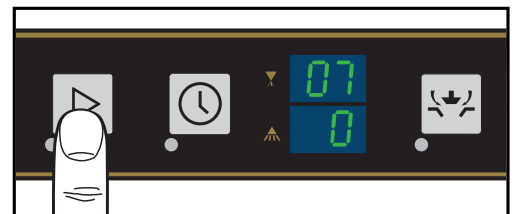

↳ Bottom display shows "0".

- ▶ Set the bottom display to "1" by pressing the programme selection button.



↳ The ON/Escape key LED flashes.

- ▶ The total capacity is reset again by pressing the ON/Escape key for 3 sec.



↳ The ON/Escape key LED illuminates for 3 sec.

- ▶ Open the door to escape and exit the menu.

### 8.9.2 Remaining capacity

The remaining capacity counts backwards from the set output capacity value and can be shown as follows:

- ▶ Open menu (see section 8.2).
- ▶ Press the programme start button until the top display shows "08".



Due to the bottom display being limited to 2 places, the value (max. 6 places) is shown as follows:

- ▶ The first two places are displayed by pressing the programme selection button.

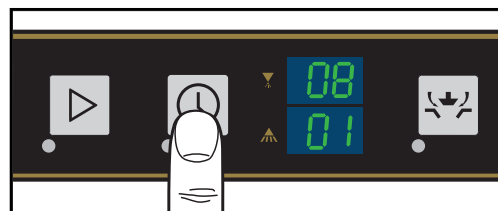

- ▶ The next two places are shown when the programme selection button is pressed.

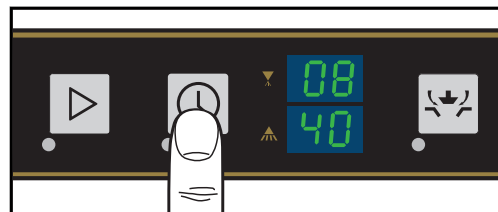

- ▶ The last two places are shown by pressing the programme selection button.

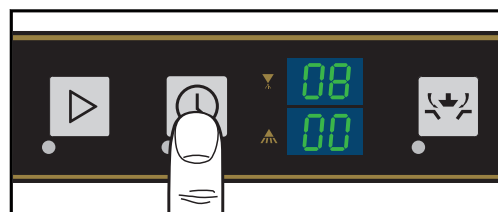

- ▶ If the key is pressed again, the first display reappears, etc.
- ▶ Open the door to escape and exit the menu.

If necessary, the value can also be set as shown in section 8.9.4.

### 8.9.3 Activate/deactivate

This must be deactivated to use the capacity monitoring.

- ▶ Open menu (see section 8.2).
- ▶ Press the programme start button until the top display shows "09".



Bottom display shows the current setting:

- "0" = deactivated
- "1" = demineralisation cartridge (assumption: 3 l/min)
- "2" = reverse osmosis system (assumption = 1.5 l/min)
- ▶ Set using the programme selection button or Drain key.

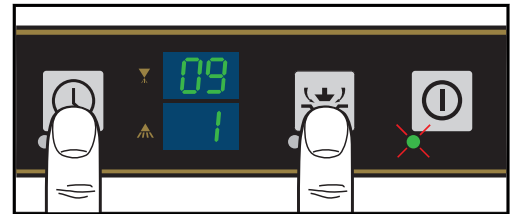

↳ The ON/Escape key LED flashes.

- ▶ The value is saved by pressing the ON/Escape key for 3 sec.

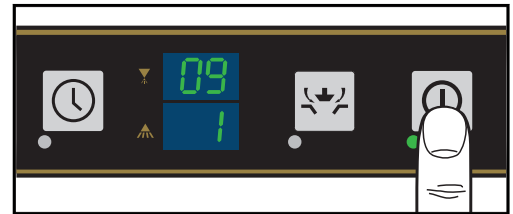

↳ The ON/Escape key LED illuminates for 3 sec.

- ▶ Open the door to escape and exit the menu.

### 8.9.4 Output capacity

Value is preset to 14000 l.

To display or change:

- ▶ Open menu (see section 8.2).
- ▶ Press the programme start button until the top display shows "10".

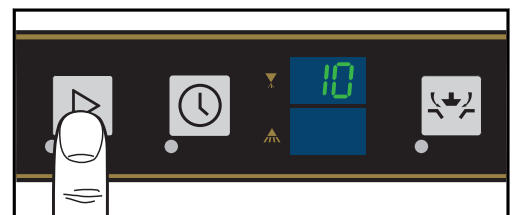

Due to the bottom display being limited to 2 places, the value (max. 6 places) is shown as follows:

# ECOMAX+ 415/515

## Settings

- ▶ The first two places are shown in the lower display by pressing the ON/Escape key.

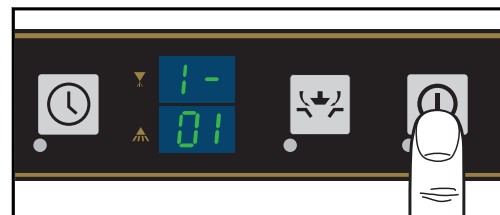

- ▶ To adjust the first two places, use the programme selection button to increase or the Drain key to reduce.

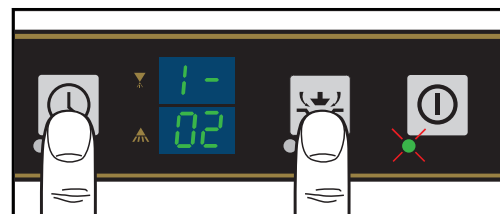

↳ The ON/Escape key LED flashes

- ▶ The next two places are shown when the programme start button is pressed.



- ▶ Set the first two places in the same way as required.
- ▶ The last two places are shown by pressing the programme start button.



- ▶ Set the first places in the same way as required.
- ▶ Press the ON/Escape key for 3 sec. to exit the menu list or to save a changed value.



↳ If the value is changed, the ON/Escape key LED illuminates for 3 sec.

- ▶ The first display is shown again when the programme start button is re-pressed.
- ▶ Open the door to escape and exit the menu.

## 8.10 Temperatures

Here, it is possible to change from standard temperatures complying to DIN 10534 to elevated temperatures complying to NSF (Thermolabel 71° C). As a result, the programme run times are extended.

- ▶ Open menu (see section 8.2).
- ▶ Press the programme start button until the top display shows "11".



Bottom display shows the current setting:

"0" = standard temperatures

"1" = increased temperatures

- ▶ Set using the programme selection button or Drain key.

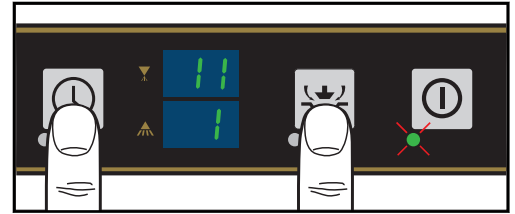

↳ The ON/Escape key LED flashes.

- ▶ The value is saved by pressing the ON/Escape key for 3 sec.

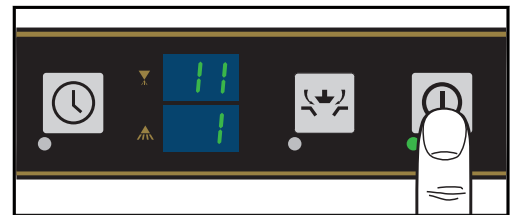

↳ The ON/Escape key LED illuminates for 3 sec.

- ▶ Open the door to escape and exit the menu.

## 8.11 Displaying the temperatures

- ▶ Open menu (see section 8.2).
- ▶ Press the programme start button until the top display shows "12".

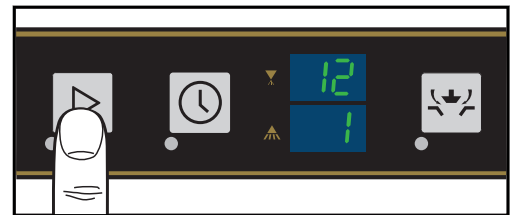

Bottom display shows the current setting:

"0" = no display of temperatures.

"1" = display shows the maximum temperature reached during the last wash programme.

"2" = display shows the current boiler and wash tank temperatures.

- ▶ Set using the programme selection button or Drain key.

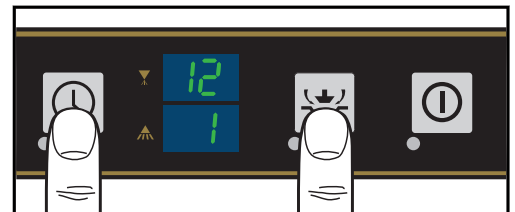

- ▶ Open the door to escape and exit the menu.

# ECOMAX+ 415/515

## Display of faults and information

## 9 Display of faults and information

### 9.1 Error

- ▶ "Er" appears in the top display.



- ▶ The error code is shown in the bottom display (see table).

Error code	Reason	Remedy
01	Temperature boiler sensor exceeded.	Contact your HOBART Service Partner.
02	Temperature boiler sensor undercut.	Contact your HOBART Service Partner.
03	Hot water tank thermostop in wash programme.	Contact your HOBART Service Partner.
05	Temperature tank sensor exceeded.	Contact your HOBART Service Partner.
06	Temperature tank sensor undercut.	Contact your HOBART Service Partner.
07	Upper limit of pressure sensor for boiler exceeded.	Contact your HOBART Service Partner.
08	Total value of pressure sensor for boiler undercut.	Contact your HOBART Service Partner.
09	Total value of pressure sensor for tank exceeded.	Contact your HOBART Service Partner.
10	Total value of pressure sensor for tank undercut.	Contact your HOBART Service Partner.
12	Water level regulation in wash tank failed.	Contact your HOBART Service Partner.
13	Filling programme monitor pressure sensor for tank.	Pump out machine.
14	Wash tank draining in pump-out programme for tank pressure sensor.	Clean the drain hose if necessary and pump out the machine again.
17	Filling monitoring by impeller sensor.	Check water supply.
18	Filling monitoring by measuring the water level in the boiler.	Check water supply.
28	Fill level of wash tank too low at programme start.	The machine refills automatically and starts the programme. If the error is permanently displayed, contact your HOBART Service Partner.
29	Capacity of external water treatment unit depleted.	Replace part or full desalination cartridge.
31	Filling monitoring	Check water supply. Contact your HOBART Service Partner.



## 9.2 Information

- The following instructions are shown with a letter combination in the display.



Display	Reason	Remedy
SA Lt	Regenerating salt depleted.	Refill regenerating salt (see section 6.3).
do or	Filling, washing or pump-out programme interrupted	Close Door.

## 10 Troubleshooting guide

### 10.1 Poor wash result

Fault type	Possible cause	Remedy
Washware not clean.	Wash arm stiff (must rotate easily by hand).	Remove wash arms and clean them thoroughly. Also check water outlet from machine to wash arm is clear.
	Wash arm nozzles are clogged (visual check).	Remove wash arm, remove cleaning caps and rinse wash arm thoroughly until all soiling is removed. Replace cleaning caps.
	Rinse nozzles clogged (usually by lime deposit).	Remove rinse arms and descale them in separate container. Check site softening system for function.
	Detergent concentration is too low or too high.	Check detergent concentration setting.
	Coarse strainer clogged.	Remove, empty and clean strainer.
	Fine strainer clogged or obstructed by lime deposits.	Remove fine strainer. If heavily soiled, soak in a vinegar solution. Then clean it thoroughly with a brush until the pores are free. The fine strainer should generally be cleaned daily.
	Wrong programme selected for heavily soiled washware.	Select programme with longer wash cycle.
Washware or glasses dry poorly.	Rinse aid dosing too low.	Increase dosage.
	Washware still greasy.	Detergent concentration too low: increase dosage. Check if detergent is appropriate. If not, choose a stronger one. Drain contaminated water and refill machine. Improve the preliminary cleaning of the washware.

Fault type	Possible cause	Remedy
	Rack is not suitable for type of dishes (sloping).	Use appropriate racks to create a sloping position which allows water to drain away from cavities.
	Washware remains in the machine too long at the end of wash cycle.	Remove washware as soon as cycle is completed to enable it to dry.
Streaks and spots on washware or glasses.	Rinse aid concentration too high (stripe or bubble formation).	Reduce dosage.
	Hard water or high mineral content.	Check water quality. Every local water works holds data on the composition of the water they supply and will provide these on request. Reference values: Ideal calcium value: 0 – 3°d (total hardness). Ideal mineral content value: for glasses, max. conductivity 100 µS/cm, for dishes, still viable to max. 400 µS/cm.
	Rack is not suitable for type of dishes (sloping).	Use appropriate racks to create a sloping position which allows water to drain away from cavities.
	Inadequate rinse aid dosing causes stains.	Increase rinse aid dosing.
	Machines with integrated softener: use of wrong salt (e.g. tablets).	Do not use salt tablets.

## 10.2 Other faults

Fault type	Potential causes	Remedy
Glasses are totally or partially cloudy.	Surface of glasses is rough and porous, this is called glass corrosion.	Use new glasses, this is not caused by a malfunction on the machine.
Glass/dish breakage.	Use of unsuitable dish or glass racks.	Use suitable racks.

## 11 Maintenance

- In order to maintain the warranty, as well as a permanently safe, efficient, and trouble-free operation of the machine(s), the required maintenance must be carried out by authorized service technicians. We therefore recommend the conclusion of an inspection and maintenance contract, which guarantees qualified support by specially trained service technicians according to a time schedule based on the operating conditions. Genuine spare parts must be used for repairs and wearing part replacements. Wearing parts include dosing hoses, rinse arm bearings, etc. In Germany, your HOBART machines are governed by the Ordinance on Indus-

trial Health and Safety and must be inspected by a qualified electrician in accordance with the intervals specified by the Institute for Work and Health of the German Social Accident Insurance [DGUV V3 (BGV A3)].

## 12 Disposal

- ▶ The machine operator is responsible for disposing of the machine and its operating materials correctly and in accordance with environmental regulations. Observe the national and local legal provisions and regulations.



## 13 Product disclaimer

### Product disclaimer

Installations and repairs carried out by non-authorized technicians or using non-genuine spare parts, and any technical alterations to the machine not approved by the manufacturer will invalidate the manufacturer's warranty and product liability.

HOBART reserves the right to make changes or improvements to its products without prior notice.

© HOBART GmbH, Offenburg 2020

## 14 Conformity



Original

### EG-Konformitätserklärung

Declaration of Conformity / Déclaration de Conformité / Declaración de Conformidad / Dichiarazione di conformità / Conformiteitsverklaring / Deklaracja zgodności / Декларация соответствия / Uygunluk beyanı / Deklaracija o skladnosti / Izjava o skladnosti / Declaração de Conformidade / Prohlášení o shodě

#### Hersteller / Dokumentationsbevollmächtigter:

Manufacturer / authorized to compile the technical file:  
 Fabricant / autorisée à constituer le dossier technique:  
 Fabricante / autorizado para unificar la información técnica:  
 Fabbricante / Responsabile della documentazione:  
 Fabrikant / Geautoriseerd om de technische documentatie samen te stellen:  
 Producent / autoryzowany przedstawiciel:  
 Изготовитель / ответственный за составление документации:  
 Üretici / Dokümantasyon yetkilisi:  
 Proizvođač / ovlašten za sastavljanje tehničkog spisa:  
 Proizvajalec / pooblaščen za dokumentacijo:  
 Fabricante / Responsável pela documentação:  
 Výrobce / osoba zplnomocněná sestavením dokumentace:

HOBART GMBH / Verena Wiedenhöfer  
 Robert-Bosch-Straße 17  
 77656 Offenburg / Germany

Maschine: Geschirrspülmaschine  
 Machine: Dishwasher  
 Machine: Machine à laver la vaisselle  
 Máquina: Lavavajillas  
 Macchina: Lavastoviglie  
 Machine: Vaatwasmachine  
 Urządzenie: Zmywarka do naczyń  
 Машина: Посудомоечная машина  
 Makine: Tezgahaltı bulayık makineleri  
 Stroj: Perilica posuda  
 Stroj: Stroj za pomivanje posode  
 Máquina: Máquina lava-loiça  
 Stroj: Myčka na nádobí

Marke: ecomax by HOBART  
 Trade mark / Marque / Marca  
 comercial / Marchio / Merk /  
 Marka / Марка / Marka / Zaštitni  
 znak / Znamka / Marca / Značka

Type: Eco+ G515 - Serie      Design State: FXB-12-04      Serial No.: 86 66 XXXXX  
 Eco+ F515 - Serie

Hiermit bestätigen wir, dass die genannte Maschine entsprechend den nachfolgend aufgeführten Normen gefertigt und geprüft worden ist.  
 Herewith our confirmation that the named machine has been manufactured and tested in accordance with the following standards.

Par la présente, nous déclarons que la machine citée ci-dessus a été fabriquée et testée en conformité aux normes.  
 Por la siguiente confirmamos que la máquina mencionada ha sido fabricada conforme a las siguientes normas.  
 Con la presente confermiamo che la macchina indicata è stata costruita in conformità alle norme di seguito riportate.  
 Hierbij bevestigen wij dat de genoemde machine is gefabriceerd en getest volgens de hiervolgende voorwaarden.  
 Niniejszym deklarujemy, że wymieniony produkt spełnia wymogi następujących norm.  
 Настоящим мы подтверждаем, что указанная машина изготовлена в соответствии с приведенными ниже нормами.  
 İşbu belge ile belirttik makinenin aşağıda listelenen normlar doğrultusunda hazırlanmış olduğunu beyan ederiz.  
 Ovimе потврђујемо да је горе наведени stroj proizveden i testiran sukladno sljedećim standardima.  
 Š tem izjavljamo, da je naveden stroj izdelan in preizkušen v skladu s spodaj navedenimi standardi.  
 Com a presente declaramos que a máquina supracitada foi construída e inspecionada segundo as normas referidas a seguir.  
 Timto potvrđujeme, že uvedeny stroj byl vyroben a zkontrolován podle následujících norem.

DIN SPEC 10534:2019-02  
 EN 55014-1:2017  
 EN 55014-2:2015  
 EN 60335-2-58:2005 + Corr. 2007 + A1:2008 + A11:2010 + A2:2015 + A12:2016  
 EN IEC 61000-6-2:2019  
 EN 61000-6-3:2007 + A1:2011  
 EN ISO 12100:2010

#### Die Maschine stimmt mit den folgenden Richtlinien überein:

The product complies with the following directives:  
 La machine est conforme aux directives fixées:  
 La máquina armoniza con las siguientes Directivas:  
 La macchina è conforme alle direttive seguenti:  
 Het product voldoet aan de volgende richtlijnen:  
 Urządzenie spełnia wymogi następujących dyrektyw:  
 Машина соответствует требованиям следующих директив:  
 Makine, aşağıdaki yönetmelikler ile uyumludur:  
 Ovaj stroj je u skladu sa sljedećim direktivama:  
 Stroj ustreza zahtevam sledećih direktiv:  
 A máquina está em conformidade com as seguintes diretivas:  
 Stroj je v skladu s ustanovenimi následujících směrníc:

2006/42/EC (Maschinenrichtlinie, Machinery-Directive)  
 2014/30/EU (EMV-Richtlinie, EMC-Directive)  
 2011/65/EU (RoHS Richtlinie, RoHS-Directive)

#### Die Schutzleze der Niederspannungsrichtlinie 2014/35/EU wurden gemäß Anhang I Nr. 1.5.1 der Maschinenrichtlinie 2006/42/EC eingehalten.

Protective Goals of the Low Voltage Directive 2014/35/EU are in compliance with Appendix I No 1.5.1 of the Machinery Directive 2006/42/EC.  
 Les objectifs de protection de la directive sur les basses tensions 2014/35/EU ont été respectés conforme à l'annexe I Nr. 1.5.1 der de la directive relative aux machines 2006/42/EC.  
 Directiva de protecciones de baja tensión 2014/35/EU estan en acuerdo con el apéndice I No 1.5.1. de la directiva de maquinaria 2006/42/EC.  
 Gli obiettivi di protezione della direttiva per basse tensioni 2014/35/EU è stata rispettata secondo allegato I n. 1.5.1 della Direttiva per macchine 2006/42/EC.  
 De veiligheidsdoelstellingen van de laagspanningsrichtlijn 2014/35/EU zijn nageleefd in overeenstemming met nr. 1.5.1 van bijlage I van de machine richtlijn 2006/42/EC.  
 Produkt spełnia wymogi bezpieczeństwa dyrektywy niskonapięciowej 2014/35/EU, zgodnie z załącznikiem I nr. 1.5.1 dyrektywy maszynowej 2006/42/EC.  
 Цели, охраняемые Директивой по высоковольтному оборудованию 2014/35/EU, соблюдены в соответствии с приложением № 1.5.1 Директивы по машинному оборудованию 2006/42/EC.  
 Aşağıdaki Gerilim Yönetmeliği 2014/35/EU'nin konusuna hedeflerine, Makine Yönetmeliği 2006/42/EC, ek I no. 1.5.1'e göre uyumludur.  
 Sigurnosni ciljevi direktive o niskom naponu 2014/35/EU udovoljavaju dodatku I br. 1.5.1. Direktive o strojevima 2006/42/EC.  
 Upoštevanji so zaščitni cilji Direktive o nizki napetosti 2014/35/EU v skladu s priložilo I, št. 1.5.1 Direktive o strojih 2006/42/EC.  
 Os objetivos de proteção da Diretiva de Baixa Tensão 2014/35/EU foram cumpridos de acordo com o Apêndice I, n.º 1.5.1 da Diretiva de Máquinas 2006/42/EC.  
 Cile ochrany dle nízkonapětové směrnice 2014/35/ES byly splněny dle přílohy I č. 1.5.1 směrnice o strojních zařízeních 2006/42/ES.

#### Bestätigt durch:

Confirmed by:

Offenburg, 07.01.2020

ppa.

Harald Disch  
 Direktor Produktentwicklung Europa  
 Director Warehouse Engineering Europe



Original

## EG-Konformitätserklärung

Declaration of Conformity / Déclaration de Conformité / Declaración de Conformidad / Dichiarazione di conformità / Conformiteitsverklaring / Deklaracja zgodności / Декларация соответствия / Угугnutuk beyanı / Deklaracija o skladnosti / Izjava o skladnosti / Declaração de Conformidade / Prohlášení o shodě

## Hersteller / Dokumentationsbevollmächtigter:

Manufacturer / authorized to compile the technical file:  
Fabricant / autorisé à constituer le dossier technique:  
Fabricante / autorizado para unificar la información técnica:  
Fabbricante / Responsabile della documentazione:  
Fabrikant / Geautoriseerd om de technische documentatie samen te stellen:  
Producent / autoryzowany przedstawiciel:  
Изготовитель / ответственный за составление документации:  
Üretici / Dokümantasyon yetkilisi:  
Proizvođač / ovlašten za sastavljanje tehničkog spisa:  
Proizvajalec / pooblaščen za dokumentacijo:  
Fabricante / Responsável pela documentação:  
Výrobce / osoba zplnomocněná sestavením dokumentace:

HOBART GMBH / Verena Wiedenhöfer  
Robert-Bosch-Straße 17  
77656 Offenburg / Germany

**Maschine:**  
Machine:  
Machine:  
Máquina:  
Macchina:  
Machine:  
Urządzenie:  
Машина:  
Makine:  
Stroj:  
Stroj:  
Máquina:  
Stroj:

**Gläserpülmaschine**  
Glasswasher  
Lave verres  
Lavavasos  
Lavabicchieri  
Glazenwasmachine  
Zmywarka do naczyń ze szkła  
Стаканомоечная машина  
Bardak yıkama  
Perlica čaša  
Stroj za pomivanje kozarcev  
Máquina lavo-copos  
Myčka na sklenice

**Marke:** ecomax by HOBART  
Trade mark / Marque / Marca  
comercial / Marchio / Merk /  
Marka / Марка / Marka / Značka  
znak / Znamka / Marca / Značka

**Type:** Eco+ G415 - Serie **Design State:** GCB-13-04 **Serial No.:** 86 61 XXXXX

Hiermit bestätigen wir, dass die genannte Maschine entsprechend den nachfolgend aufgeführten Normen gefertigt und geprüft worden ist.

Herewith our confirmation that the named machine has been manufactured and tested in accordance with the following standards.

Par la présente, nous déclarons que la machine citée ci-dessus a été fabriquée et testée en conformité aux normes.

Por la siguiente confirmamos que la máquina mencionada ha sido fabricada conforme a las siguientes normas.

Con la presente confermiamo che la macchina indicata è stata costruita in conformità alle norme di seguito riportate.

Hierbij bevestigen wij dat de genoemde machine is gefabriceerd en getest volgens de hiervolgende voorwaarden.

Niniejszym deklarujemy, że wymieniony produkt spełnia wymogi następujących norm.

Настоящим мы подтверждаем, что указанная машина изготовлена в соответствии с приведенными ниже нормами.

İşbu belge ile belirttiğim makinenin aşağıda listelenen normlar doğrultusunda hazırlanmış olduğunu beyan ederiz.

Ovime potvrdujemo da je gore navedeni stroj proizveden i testiran sukladno sljedećim standardima.

S tem izjavljamo, da je naveden stroj izdelan in preizkušen v skladu s spodaj navedenimi standardi.

Com a presente declaramos que a máquina supracitada foi construída e inspeccionada segundo as normas referidas a seguir.

Tímto potvrzujeme, že uvedený stroj byl vyroben a zkontrolován podle následujících norem.

DIN SPEC 10534:2019-02  
EN 55014-1:2017  
EN 55014-2:2015  
EN 60335-2-58:2005 + Corr. 2007 + A1:2008 + A11:2010 + A2:2015 + A12:2016  
EN IEC 61000-6-2:2019  
EN 61000-6-3:2007 + A1:2011  
EN ISO 12100:2010

## Die Maschine stimmt mit den folgenden Richtlinien überein:

The product complies with the following directives:

La machine est conforme aux directives fixées:

La máquina armoniza con las siguientes Directivas:

La macchina è conforme alle direttive seguenti:

Het product voldoet aan de volgende richtlijnen:

Urządzenie spełnia wymogi następujących dyrektyw:

Машина соответствует требованиям следующих директив:

Makine, aşağıdaki yönetmelikler ile uyumludur:

Ovaj stroj je u skladu sa sljedećim direktivama:

Stroj ustreza zahtevam sledećih direktiv:

A máquina está em conformidade com as seguintes diretivas:

Stroj je v souladu s ustanoveními následujících směrnic:

2006/42/EC (Maschinenrichtlinie, Machinery-Directive)  
2014/30/EU (EMV-Richtlinie, EMC-Directive)  
2011/65/EU (RoHS Richtlinie, RoHS Directive)

## Die Schutzziele der Niederspannungsrichtlinie 2014/35/EU wurden gemäß Anhang I Nr. 1.5.1 der Maschinenrichtlinie 2006/42/EC eingehalten.

Protective Goals of the Low Voltage Directive 2014/35/EU are in compliance with Appendix I No 1.5.1 of the Machinery Directive 2006/42/EC.

Les objectifs de protection de la directive sur les basses tensions 2014/35/EU ont été respectés conforme à l'annexe I Nr. 1.5.1 der de la directive relative aux machines 2006/42/EC.

Directiva de protecciones de baja tensión 2014/35/EU estan en acuerdo con el apéndice I No 1.5.1 de la directiva de maquinaria 2006/42/EC.

Gli obiettivi di protezione della direttiva per basse tensioni 2014/35/EU è stata rispettata secondo allegato I n. 1.5.1 della Direttiva per macchine 2006/42/EC.

De veiligheidsdoelstellingen van de laagspanningsrichtlijn 2014/35/EU zijn nageleefd in overeenstemming met nr. 1.5.1 van bijlage I van de machine richtlijn 2006/42/EC.

Produkt spełnia wymogi bezpieczeństwa dyrektywy niskonapięciowej 2014/35/EU, zgodnie z załącznikiem I nr. 1.5.1 dyrektywy maszynowej 2006/42/EC.

Цели, охраняемые Директивой по высоковольтному оборудованию 2014/35/EU, соблюдены в соответствии с приложением № 1.5.1 Директивы по машинному оборудованию 2006/42/EC.

Alçak Gerilim Yönetmeliği 2014/35/EU'nin koruyucu hedeflerine, Makine Yönetmeliği 2006/42/EC, ek I no. 1.5.1'e göre uyumludur.

Sigurnosni ciljevi direktive o niskom naponu 2014/35/EU udovoljavaju dodatku i br. 1.5.1. Direktive o strojevima 2006/42/EC.

Upoštevaní so začítaní cilji Direktive o nízkí napetosti 2014/35/EU v skladu s prílohou I, št. 1.5.1 Direktive o strojih 2006/42/EC.

Os objetivos de proteção da Diretiva de Baixa Tensão 2014/35/EU foram cumpridos de acordo com o Apêndice I, n.º 1.5.1 da Diretiva de Máquinas 2006/42/EC.

Cile ochrany die niskonapiětové směrnice 2014/35/ES byly splněny dle přílohy I č. 1.5.1 směrnice o strojních zařízeních 2006/42/ES.

## Bestätigt durch:

Confirmed by:

Offenburg, 07.01.2020

ppa.

Harald Disch  
Direktor Produktentwicklung Europa  
Director Warewash Engineering Europe

**HOBART GmbH**

ecomax by HOBART  
Robert-Bosch-Str. 17  
77656 Offenburg  
Deutschland  
Tel.: +49 (0)1803 66 29  
Fax: +49 (0)1803 63 29.600-23 19  
E-Mail: info@ecomaxbyhobart.de  
Internet: www.ecomaxbyhobart.de

**HOBART Export**

Robert-Bosch-Str. 17  
77656 Offenburg  
Germany  
Phone: +49 (0)781.600-2820  
Fax: +49 (0)781.600-2819  
E-Mail: info-export@hobart.de  
Internet: www.hobart-export.com

**Hobart UK.**

Southgate Way,  
Orton Southgate,  
Peterborough  
PE2 6GN  
United Kingdom  
Tel.: +44 (0)844 888 7777  
Republic of Ireland: +353 (0)1246 0248  
Fax: +44 (0)1733 361 347  
E-mail: sales@hobartuk.com  
Internet: www.hobartuk.com

**Compagnie HOBART SAS**

Allée du 1er mai  
77183 Croissy Beaubourg  
FRANCE  
Tel: +33 (0)1 64 11 60 00  
Fax: +33 (0)1 64 11 60 10  
E-mail: contact@hobart.fr  
Internet: www.hobart.fr

**Hobart Nederland BV**

Pompmolenlaan 12  
3447 GK Woerden  
Telefoon +31 (0)348 462626  
Fax: +31 (0)348 430117  
E-mail: info@hobartnederland.nl  
Internet: www.hobartnederland.nl

**Hobart Foster Belgium bvba/sprl**

Industriestraat 6  
1910 Kampenhout  
Telefoon +32 (0) 16.60.60.40  
Fax +32 (0) 16.60.59.88  
E-mail: info@hobart.be  
Internet: www.hobart.be

**Hobart Norge**

Gamle Drammenvei 120  
N-1363 Høvik  
Tlf.: +47-67109800  
Fax.: +47-67109801  
E-post: post@hobart.no  
Hjemmeside: www.hobart.no

**Hobart Scandinavia ApS**

Håndværkerbyen 27  
2670 Greve  
Danmark  
Tlf.: +45 4390 5012  
Fax.: +45 4390 5002  
E-mail: salg@hobart.dk  
Internet: www.hobart.dk

**Hobart Sweden/Finland**

Tel: +46 8 584 50 920  
E-mail: info@hobart.se  
Internet: www.hobart.se

**Australia**

**Hobart Food Equipment**  
Unit 1 / 2 Picken Street,  
Silverwater NSW, 2128  
Tel: +61 1800 462 278  
Fax: +61 02 9714 0222  
E-mail: sales@hobartfood.com.au  
Internet: www.hobartfood.com.au

**HOBART China**

15th Floor, Building A  
New Caohejing International Business  
Center  
391 Gui Ping Road  
Shanghai, 200233  
Telephone: +86 (0)21 34612000  
Fax: +86 (0)21 34617166  
Internet: www.hobartchina.com

**HOBART Korea LLC**

7th Floor, Woonsan Bldg, 108, Bangi-dong  
Songpa-gu, Seoul 138-050  
Korea  
Telephone: +82 2 34 43 69 01  
Fax: +82 2 34 43 69 05  
E-mail: contact@hobart.co.kr  
Internet: www.hobart.co.kr

**HOBART (Japan) K.K.**

6-16-16 Minami-Oi, Shinagawa-ku,  
Tokyo 140-0013  
Japan  
Telephone: +81 3 5767 8670  
Fax: +81 3 5767 8675  
E-mail: info@hobart.co.jp  
Internet: www.hobart.co.jp

**Hobart International (S) Pte Ltd**

158, Kallang Way, #06-03/05  
Singapore 349245  
Telephone: +65 6846 7117  
Fax: +65 6846 0991  
E-mail: enquiry@hobart.com.sg  
Internet: http://www.hobart.com.sg

**Hobart Thailand**

43 Thai CC Tower Building,  
31st FL, Room No. 310-311,  
South Sathorn Rd., Yannawa,  
Sathorn, Bangkok, 10120  
Thailand  
Telephone: +66(0)2-675-6279-81  
Fax: +66(0)2-675-6282  
E-mail: enquiry@hobartthailand.com  
Internet: http://www.hobartthailand.com

**ITW India Pvt Ltd.**

501-502 Vipul Trade Centre  
Sector 48 Sohna Road  
Gurgaon 122001  
Telephone: +91 124 4245430  
Fax: +91 124 4245432