



BD20036 - Lincat Blu Refrigerated Chef Base - W 914 mm - 600 W

In busy kitchens where speed is crucial, caterers need quick and easy access to food at the point of cooking, Blu^o refrigerated chef bases provides the ideal solution.

- ✔ Designed to accommodate heavy equipment, including Opus 800 Series chargrills, griddles and hobs
- ✔ Drawers hold 1/1 GN 100mm deep containers
- ✔ Allows bulk storage and easy access to food at point of cooking
- ✔ Ideal for meat and fish
- ✔ Adjustable thermostat -2° to +8°C
- ✔ Self closing heavy duty drawers
- ✔ Supplied on castors as standard

Specifications

Summary

Brand	Lincat
Range Name	Blu
Power Type	Electric
Unit Type	Free-standing
Available in UK Only	No
UK Warranty	2 Years Parts and Labour Warranty
Export Warranty	Contact your local dealer
GTIN Code	5056105117926

Power and Performance

Gastronorm Capacity	2 x GN 1/1
Total Power kW	0.6
Temperature Range °C	-2 to +8
Temperature Control	Electronic
Cooling Capacity Watts	600
Energy Grade	D
Annual Energy Consumption kWh/Annum	982
Climate Class	5

Key Specifications

Refrigerant Type	R452a
Construction/Finish	304 Grade S/S Ext/Int
Number of Drawers	2
Base Mounting	Castors
Insulation Material/Thickness	Cyclopentane [60mm]
Maximum Ambient Temperature °C	40
Auto Defrost	Yes
HACCP Compliant	Yes

Weights and Dimensions

Unit Height (External) mm	614
Unit Width (External) mm	916
Unit Depth (External) mm	826
Net Weight Kg	124

Supply Connections

Requires Installation	No
Requires Electrical Supply	Yes
UK 3 Pin Plug	Yes
Requires Hardwiring	No
Electrical Supply Rating Watts	600
Single Phase Amps	1.5
Single Phase Voltage	230

Shipping

Packed Weight Kg	137
Packed Height cm	75
Packed Width cm	107
Packed Depth cm	88

Technical Picture

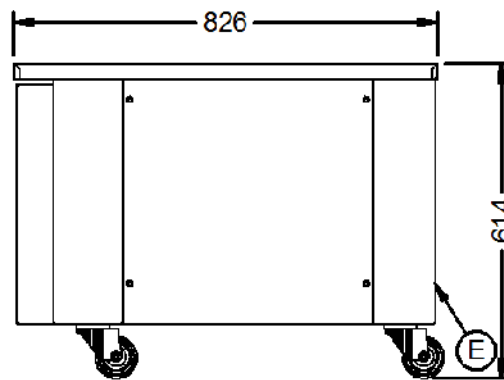
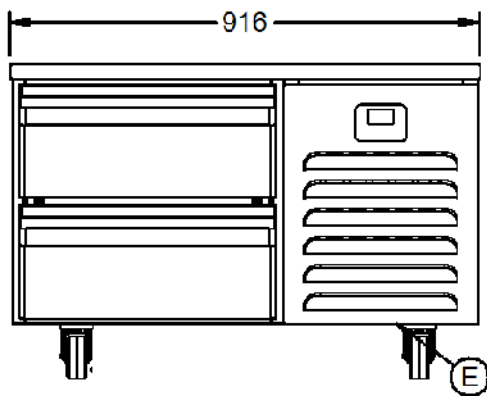

Lincat Limited

Whisby Road,
Lincoln, LN6 3QZ,
United Kingdom

Company No: 2175448

A member company of



Customer Care

Tel: +44 1522 875500
Email: care@lincat.co.uk

Export Customers

Tel: +44 1522 503250
Email: export@lincat.co.uk

Opening Hours

Monday – Friday:
8.30am – 5pm