



Combi Steamer

Convotherm 4 Table-Top Models

Operating Manual UL, USA – Original, ENG

Your meal. Our mission.



FOR THE INSTALLER, OPERATOR, RESPONSIBLE OWNER

FOR YOUR SAFETY

Do not store or use gasoline or other flammable vapors or liquids in the vicinity of this or any other appliance.



WARNING

Improper installation, adjustment, alteration, service, or maintenance may cause property damage, injury, and death. Carefully read the installation, operating, and maintenance instructions before installing or servicing this equipment.



WARNING

Disconnect power at the main external power switch before servicing or repairing a combi steamer.



WARNING

To reduce the risk of electric shock, do not remove or open cover. No user serviceable parts inside. Refer servicing to qualified personnel. Disconnect power supply before servicing.

IMPORTANT

IT IS MANDATORY TO POST INSTRUCTIONS WHICH ARE TO BE FOLLOWED IN THE EVENT THE USER SMELLS GAS. THESE INSTRUCTIONS MUST BE LOCATED IN A PROMINENT LOCATION AND BE FULLY UNDERSTOOD BY ALL USERS OF THIS EQUIPMENT. THIS INFORMATION NEEDS TO BE OBTAINED FROM YOUR LOCAL GAS SUPPLIER.

ALL SERVICE MUST BE PERFORMED BY A QUALIFIED CONVOTHERM AUTHORIZED TECHNICIAN.

KEEP AREA FREE AND CLEAR OF COMBUSTIBLES.

Installation

- Installation of this appliance must be done by a licensed professional when installed in the Commonwealth of Massachusetts.
- The wiring diagram is located on the inner part of the side panel.

Customer documentation

- The customer documentation is part of the combi steamer.
- Keep the customer documentation manuals handy at all times so that you can look up any required information.
- Keep the customer documentation manuals for the entire life of the appliance.
- Carefully read the installation manual, the operating manual, and the operating instructions before using, handling, and working on this appliance.
- If you transfer the combi steamer to a new owner, make sure to give the new owner the customer documentation manuals as well.

Table of Contents

1	General Information	7
1.1	Environmental Protection	8
1.2	Identifying Your Combi Steamer	9
1.3	Customer Documentation Structure	10
1.4	Safety information that must be read without exception	11
1.5	About This Operating Manual	12
2	Configuration and Functions	14
2.1	The Combi Steamer's Functions	15
2.2	The Combi Steamer's Configuration and Functions	17
2.3	Control Panel Layout and Functions	20
3	For Your Safety	21
3.1	Basic Safety Instructions	22
3.2	Your Combi Steamer's Intended Use	23
3.3	Warning Labels on the Combi Steamer	25
3.4	Overview of Hazards	28
3.5	Hazards and Safety Measures During Operation	30
3.6	Hazards and Safety Measures During Cleaning	37
3.7	Hazards and Safety Measures During Maintenance	42
3.8	Safety Devices	43
3.9	Staff and Work Area Requirements	45
3.10	Personal Protective Equipment	46
4	How to Cook with Your Combi Steamer	47
4.1	Basic Guidelines for Putting Food Into the Combi Steamer	48
4.1.1	Placing Food Containers in Size X.10 Appliances	49
4.1.2	Placing Food Containers in Size X.20 Appliances	50
4.1.3	Combi Steamer Loading Capacity	52
4.2	General Cooking Instructions	53
4.2.1	Safely Using the Appliance	54
4.2.2	Turning the Combi Steamer On and Off (Lighting Instructions)	57
4.2.3	Cooking Procedures	59
4.2.4	Smoking Procedures	61
4.3	Specific Cooking Instructions	65
4.3.1	Safely Using the Appliance	66
4.3.2	Safely Opening and Closing the Appliance Door	68
4.3.3	Placing Food Inside and Taking It Out	69
4.3.4	Putting Food Inside the Mobile Shelf Rack	71
4.3.5	Taking Food Out from the Mobile Shelf Rack	73
4.3.6	Placing the Roll-In Frame for the Mobile Shelf Rack Inside the Cooking Compartment	74
4.3.7	Using the Transport Trolley to Put Food Inside the Cooking Compartment and Take It Out	76
4.3.8	Putting Away and Removing the Core Temperature Probe	81
4.3.9	Using a USB Stick	82
4.3.10	Removing and Installing the Racks	83
4.3.11	Filling the Smoker Box, Placing It Inside the Appliance, and Removing It from the Appliance	86

5	How to Clean the Combi Steamer	89
5.1	Combi Steamer Cleaning Basics	90
5.1.1	Cleaning Methods	91
5.1.2	Cleaning schedule	93
5.1.3	Cleaning agents	95
5.1.4	Supplying Cleaning Agents	96
5.2	General Cleaning Instructions	97
5.2.1	Working Safely When Cleaning	98
5.2.2	How to Fully Automatically Clean the Cooking Compartment Using Canisters	100
5.2.3	How to Fully Automatically Clean the Cooking Compartment Using the Single-Measure Dispensing Mode	102
5.2.4	How to Semi-Automatically Clean the Cooking Compartment in Table-Top Models with Racks	104
5.2.5	How to Semi-Automatically Clean the Cooking Compartment in Table-Top Models with a Mobile Shelf Rack	106
5.2.6	How to Clean the Cooking Compartment Without Using Cleaning Agents	109
5.2.7	How to Clean the Double Glass Door	110
5.2.8	How to Clean the Cooking Compartment Section Behind the Suction Panel	111
5.2.9	How to Clean the Hygienic Plug-In Gasket Thoroughly	113
5.3	Specific Cleaning Instructions	114
5.3.1	Safely Using the Appliance	115
5.3.2	Replacing the Rinse Aid Canister	117
5.3.3	Replacing the Cleaning Agent Canister	119
5.3.4	Adding Cleaning Agent from Single-Measure Dispensing Bottles to the Inside of the Cooking Compartment	121
5.3.5	Releasing the Suction Panel and Locking it Back in Place	123
5.3.6	Removing and Installing the Hygienic Plug-In Gasket	126
5.3.7	Releasing the Inner Glass Door and Locking it Back in Place	127
6	How to Perform Maintenance on the Combi Steamer	128
6.1	Maintenance Basics	129
6.1.1	Warranty Information / How to Contact Customer Service	130
6.1.2	Maintenance schedule	131
6.2	Troubleshooting	132
6.2.1	Troubleshooting – Error Codes	133
6.2.2	Emergency Mode	134
6.2.3	Troubleshooting – Problems During Operation	136
6.3	Maintenance work	138
6.3.1	Working Safely When Performing Maintenance	139
6.3.2	Replacing the hygienic plug-in gasket	140
6.3.3	Replacing the oven light halogen lamp	141

1 General Information

Purpose of this section

This section provides information on how to identify your combi steamer and how to use this manual.

Contents

This section covers the following subjects:

	Page
Environmental Protection	8
Identifying Your Combi Steamer	9
Customer Documentation Structure	10
Safety information that must be read without exception	11
About This Operating Manual	12

1.1 Environmental Protection

Policy statement

Our customers' expectations, the legal regulations and standards we have to follow, and our company's reputation are what drives the quality and service behind all our products.

Our environmental management policy is not only designed to ensure that we are always in full compliance with all environmental laws and regulations, but also reflects our commitment to the environment and to continuously improving our performance in this field.

In order to ensure that we meet all of our environmental goals while maintaining the high quality of our products, and that things stay this way, we have developed a quality and environmental management system.

This system meets the requirements set forth in ISO 9001:2008 and ISO 14001:2004.

Environmental protection measures

The following measures apply to this product:

- Uses fully compostable packing products
- Uses RoHS-compliant products
- Complies with the REACH regulation
- Recommends and uses biodegradable cleaning agents
- E-waste recycling
- Environmentally friendly disposal of old appliances through the manufacturer

Join us in our commitment to protecting the environment!

1.2 Identifying Your Combi Steamer

Nameplate location

The nameplate is found on the left side of the combi steamer.

Nameplate layout and structure

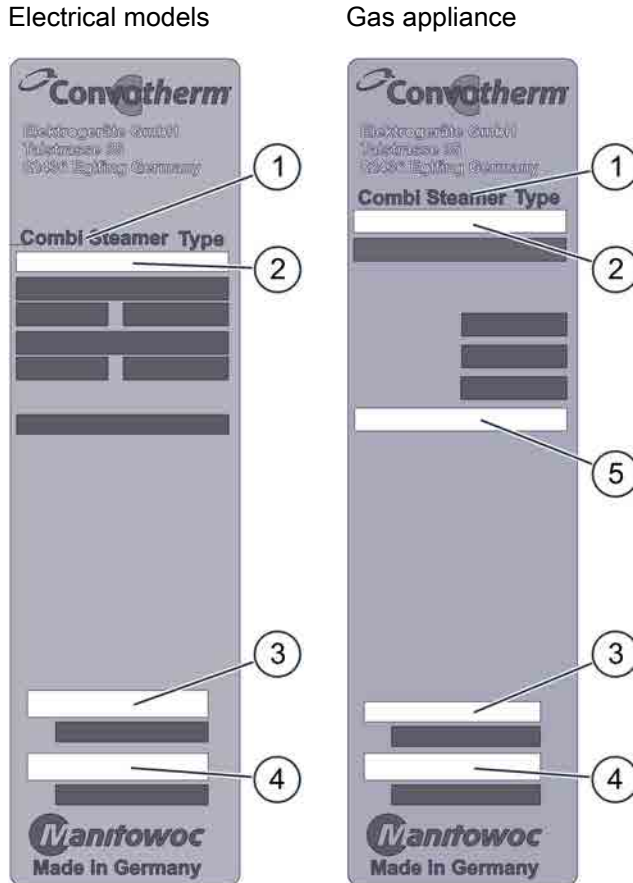

Designation

1	Appliance name	Combi Steamer
2	Trade name	
	Letters	Meaning
	C4	Convotherm 4 line of appliances
	eT	easyTouch controls
	eD	easyDial controls
	xx.yy numbers	Appliance size
	EB	Electrical models with boiler
	ES	Electrical models with water injection
	GB	Gas appliance with boiler
	GS	Gas appliance with water injection
3	Item number	
4	Serial number	
	Letters	Meaning
	Heating method	<ul style="list-style-type: none"> ▪ Electrical models (X, V) ▪ Gas appliance (Y, W)
	Steam generation method	<ul style="list-style-type: none"> ▪ Sprayer (S) ▪ Boiler (B)
	Appliance size	<ul style="list-style-type: none"> ▪ 6.10 (1) ▪ 6.20 (2) ▪ 10.10 (3) ▪ 10.20 (4)
	Year of manufacture	<ul style="list-style-type: none"> ▪ 2014 (14) ▪ 2015 (15) ▪ ...
	Month of manufacture	<ul style="list-style-type: none"> ▪ January (01) ▪ February (02) ▪ March (03) ▪ ...
	Consecutive number	4-digit
5	Gas specifications	BTU/hr, type of gas

1.3 Customer Documentation Structure

Customer documentation parts

The customer documentation for the combi steamer is made up of the following:

- Installation manual
- Operating manual (this manual)
- easyTouch operating instructions (extract from the on-screen help pages)
- On-screen help integrated into easyTouch (complete instructions for using the software)
- easyDial operating instructions

Installation manual topics

The installation manual is intended for trained qualified personnel; see “*Staff Requirements*” in the installation manual.

It covers the following topics:

- **Configuration and functions:** Describes the parts that are relevant when installing the combi steamer
- **Safety:** Goes over all the hazards involved in the various installation activities and how to prevent and/or counter them
- **Transportation:** Contains important information on transporting the combi steamer
- **Setup:** Lists and describes the various setup options for the combi steamer
- **Installation:** Goes over all the necessary utility and hose connections
- **Placing into operation:** Explains how to put the combi steamer into operation for the first time
- **Removal from service:** Goes over the activities that need to be carried out at the end of the combi steamer’s lifecycle
- **Technical data, scale drawings, and connection points:** Contain all the required technical information concerning the combi steamer
- **Checklists:** Includes checklists for the combi steamer’s installation and warranty

Operating manual topics

The operating manual is intended for briefed staff and trained qualified staff; see “*Staff Requirements* on page 45” in the operating manual.

It covers the following topics:

- **Configuration and functions:** Describes the parts that are relevant when using the combi steamer
- **Safety:** Goes over all the hazards involved in using the combi steamer and how to prevent and/or counter them
- **Cooking:** Goes over the various rules, workflows, operating steps, and actions required for cooking
- **Cleaning:** Lists and describes the cleaning processes, cleaning agents, workflows, operating steps, and actions required for cleaning
- **Maintenance:** Contains warranty information; the maintenance schedule; information on faults, errors, and emergency mode; and the workflows, operating steps, and actions required for maintenance

Operating instructions and on-screen help (easyTouch only) topics

The operating instructions and the on-screen help (easyTouch only) are intended for briefed staff and trained qualified staff; see “*Staff Requirements* on page 45” in the operating manual. For appliances with easyTouch, the operating instructions will be an extract from the on-screen help pages.

The operating instructions and the on-screen help (easyTouch only) cover the following topics:

- **User interface layout:** Goes over the combi steamer’s user interface
- **Using the software:** Contains instructions on how to enter and access cooking profiles, access cleaning profiles, and start cooking and cleaning sequences; describes the various settings and goes over how to import and export data
- **Select cooking profiles:** Lists tried-and-true cooking profiles

1.4 Safety information that must be read without exception

Safety information found in the documentation for the customer

Only the installation manual and operating manual provide safety information for the combi steamer.

The installation manual provides safety information for the transportation, setup, installation, placing-into-operation, and removal-from-service tasks it describes.

The operating manual provides safety information for the cooking, cleaning, and maintenance tasks it describes.

When using the operating instructions, the operating manual or installation manual should always be consulted in order to obtain the relevant safety information. When performing activities that go beyond simply using the software, the safety information in the operating manual and installation manual must always be observed.

Parts of this document that must be read without exception

Failure to take the information in this document into account may result in death, injury, or property damage.

In order to ensure their safety and the safety of others, everyone working with/on the combi steamer must read and understand the following parts of this document before starting any work:

- The “*For Your Safety* on page 21” section
- The sections describing the work that will be carried out



Danger symbol

Danger symbol	Meaning
	Used to warn of potential injury. Observe all the precautionary statements following this symbol in order to avoid injury or death.



Precautionary statements

The precautionary statements in this manual are categorized using the following hazard levels:

Hazard level	Consequences	Likelihood
 DANGER	Death/severe injury (irreversible)	Imminent
 WARNING	Death/severe injury (irreversible)	Potential
 CAUTION	Minor injury (reversible)	Potential
NOTICE	Property damage	Potential

1.5 About This Operating Manual

Purpose

The purpose of this operating manual is to provide everyone working with/on the combi steamer with the information they will need to carry out operation, cleaning, and limited maintenance work safely and correctly.

Target groups

Name of target group (user)	Tasks
Combi steamer owner or the owner's employee who is responsible for the appliance and for the staff operating it	<p>Is responsible for instructing all other users on how to safely and correctly operate, clean, and maintain the appliance. Is also responsible for ensuring that the appliance is ready for operation before use. These responsibilities include:</p> <ul style="list-style-type: none"> ▪ Briefing all users on all of the combi steamer's safety-relevant functions, mechanisms, and devices ▪ Showing all users how to operate or otherwise work with the appliance as required by their tasks and training them as required by the "<i>Parts of this document that must be read without exception</i> on page 11" section. ▪ Being the person to whom all problems and other issues related to the appliance are reported and taking appropriate measures to correct them or arranging for said measures to be taken. ▪ Being responsible for ensuring that the appliance and its components are maintained at the required intervals.
Cook	<p>Primarily takes care of organizational tasks, such as:</p> <ul style="list-style-type: none"> ▪ Entering cooking profile data ▪ Editing existing cooking profiles in the cookbook ▪ Coming up with new cooking profiles ▪ Configuring the appliance's settings <p>and takes care of all operator tasks as well if necessary.</p>
Operator	<p>Actually operates the combi steamer, taking care of tasks such as:</p> <ul style="list-style-type: none"> ▪ Putting food into the combi steamer ▪ Starting cooking profiles ▪ Taking out the food once it has been cooked ▪ Cleaning the combi steamer ▪ Changing the racks and other equipment in the combi steamer. For example: switching between racks and mobile shelf racks ▪ Limited maintenance work

Operating Manual Outline

Section / sub-section	Purpose	Target group
General Information	<ul style="list-style-type: none"> ▪ Helps identify your combi steamer ▪ Explains how to use this operating manual 	Cook
Configuration and Functions	<ul style="list-style-type: none"> ▪ Describes the combi steamer's functions ▪ Describes specific combi steamer components and indicates where they are located 	Cook Operator
For Your Safety	<ul style="list-style-type: none"> ▪ Describes the combi steamer's intended use ▪ Describes all the risks and hazards posed by the combi steamer, as well as appropriate instructions on how to prevent and/or counter them <p>Read this section very carefully!</p>	Cook Operator

Section / sub-section	Purpose	Target group
How to Cook with Your Combi Steamer	<ul style="list-style-type: none"> ▪ Describes the combi steamer's options for loading food and the maximum loads that are allowed to be put inside ▪ Explains how to turn on the combi steamer ▪ Includes instructions regarding the work sequences involved in cooking and rethermalizing food ▪ Includes instructions regarding the combi steamer steps that are required repeatedly when cooking and rethermalizing food 	Cook Operator
How to Clean the Combi Steamer	<ul style="list-style-type: none"> ▪ Goes over the general cleaning procedure ▪ Includes the cleaning schedule ▪ Describes the cleaning agents and how they must be supplied ▪ Includes instructions regarding the work sequences involved in cleaning the combi steamer ▪ Includes and refers to instructions regarding the combi steamer steps that will be required repeatedly when cleaning the steamer 	Operator
How to Perform Maintenance on the Combi Steamer	<ul style="list-style-type: none"> ▪ Includes the maintenance schedule ▪ Provides information on how to use the emergency mode if faults or malfunctions occur ▪ Includes a list of potential faults, malfunctions, and errors and what to do if they occur ▪ Includes instructions for the maintenance work that the user is allowed to carry out themselves ▪ Refers to instructions regarding the combi steamer steps that will be required when performing maintenance work on the steamer 	Operator

Decimal mark used

In order to ensure that all numbers can be properly understood internationally, a decimal point is always used.

2 Configuration and Functions

Purpose of this section

This section describes the combi steamer's configuration and explains its functions.

Contents

This section covers the following subjects:

	Page
The Combi Steamer's Functions	15
The Combi Steamer's Configuration and Functions	17
Control Panel Layout and Functions	20

2.1 The Combi Steamer's Functions

Cooking operating modes

Your combi steamer can be used to cook a variety of food. To do this, the combi steamer can be run in any of the following operating modes:

- Steam
- Combi-steam
- Convection
- Smoker (optional)

Standard cooking methods

By using the cooking operating modes together with the HumidityPro, Crisp&Tasty, Fan speed, and BakePro ACS+ extra functions, you can do the following, for example:

- | | | |
|--------------|----------------------|----------------|
| ▪ Boiling | ▪ Steaming | ▪ Stewing |
| ▪ Blanching | ▪ Poaching | ▪ Braising |
| ▪ Roasting | ▪ Broiling | ▪ Baking |
| ▪ Scalloping | ▪ Cooking au gratin | ▪ Thawing food |
| ▪ Preserving | ▪ Smoking (optional) | |

Special cooking methods

If you are using **easyTouch**, you can do the following in combination with the operating modes and additional functions:

- | | | |
|---------------------------|----------------------|---------------------------|
| ▪ Low-temperature cooking | ▪ ΔT cooking | ▪ ecoCooking |
| ▪ Cook & Hold | ▪ Overnight cooking | ▪ Low-oxygen slow cooking |

Rethermalization operating modes

Your combi steamer can be used to rethermalize a variety of food. To this end, the combi steamer can be run in any of the following three operating modes:

- À la carte rethermalization
- Banquet rethermalization (with easyTouch only)
- Plate rethermalization (with easyTouch only)

Cooking profiles and cookbook

A cooking profile is a combination of cooking parameters, such as cooking temperature and cooking time. You can create your own cooking profiles and manage them in the “cookbook.” In addition, the “cookbook” also comes with predefined cooking profiles.

Oven cleaning with easyTouch

There are four oven cleaning operating modes available:

- Cleaning without using cleaning agents
- ConvoClean+ fully automatic cleaning: any combination of four cleaning levels, three cleaning durations, and the additional “steam disinfection” and “drying” functions
- Semi-automatic cleaning
- Cleaning with ConvoCare rinse aid only

Oven cleaning with easyDial

There are ten oven cleaning profiles available:

- “Rinse with water” cleaning profile
- ConvoClean fully automatic cleaning: Eight cleaning profiles for varying levels of soiling available, with some of them including steam disinfection and drying
- Semi-automatic cleaning profile

2.2 The Combi Steamer's Configuration and Functions

Parts and functions (electrical table-top models)

The figure below shows a size 6.10 combi steamer used as an example representing all electrical table-top models:

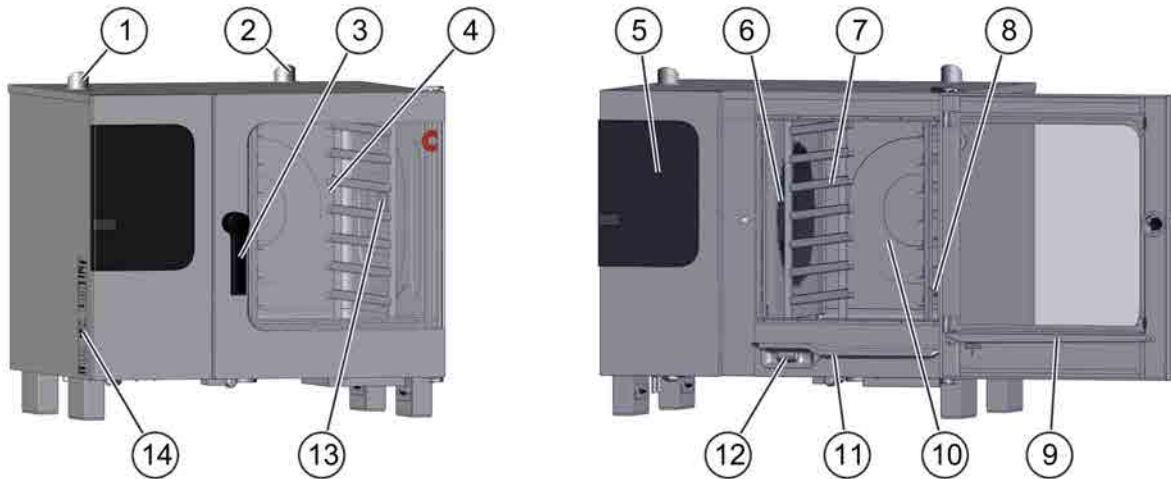

No.	Designation	Function
1	Ventilation port	<ul style="list-style-type: none"> Draws in ambient air in order to remove moisture from the cooking compartment Compensates for pressure fluctuations inside the cooking compartment
2	Exhaust vents	Lets hot steam escape
3	Door handle	<ul style="list-style-type: none"> Used to open and close the appliance door Cracked-open position for safely opening the appliance ("safety lock") Closing-shut function Antibacterial material with silver ions ("HygienicCare")
4	Appliance door	<ul style="list-style-type: none"> Seals the cooking compartment When opened, it can be slid backwards along the appliance's side in order to save space ("disappearing door") (optional)
5	Control panel	<ul style="list-style-type: none"> Used to operate the appliance Antibacterial ("HygienicCare")
6	Suction panel	<ul style="list-style-type: none"> Used to distribute heat uniformly within the cooking compartment Separates the fan compartment from the cooking compartment
7	Rack	Used to hold standard-size food containers
8	Core temperature probe, optional sous vide probe (can be externally inserted)	Used to measure the food's internal temperature
9	Door drip tray	Collects the condensate that runs down the inside of the appliance door
10	Cooking compartment	Is where food is placed while it is being cooked
11	Appliance drip tray	Collects liquids and condensate dripping from the cooking compartment
12	Pullout spray head	<ul style="list-style-type: none"> Meant exclusively for rinsing the cooking compartment with water Is retracted automatically into its holder after being used Antibacterial ("HygienicCare")

No.	Designation	Function
13	Oven light	<ul style="list-style-type: none"> ▪ Illuminates the cooking compartment ▪ Program-controlled
14	Nameplate	Used to identify the appliance

Parts and functions (gas table-top models)

The figure below shows a size 6.10 combi steamer used as an example representing all gas table-top models:

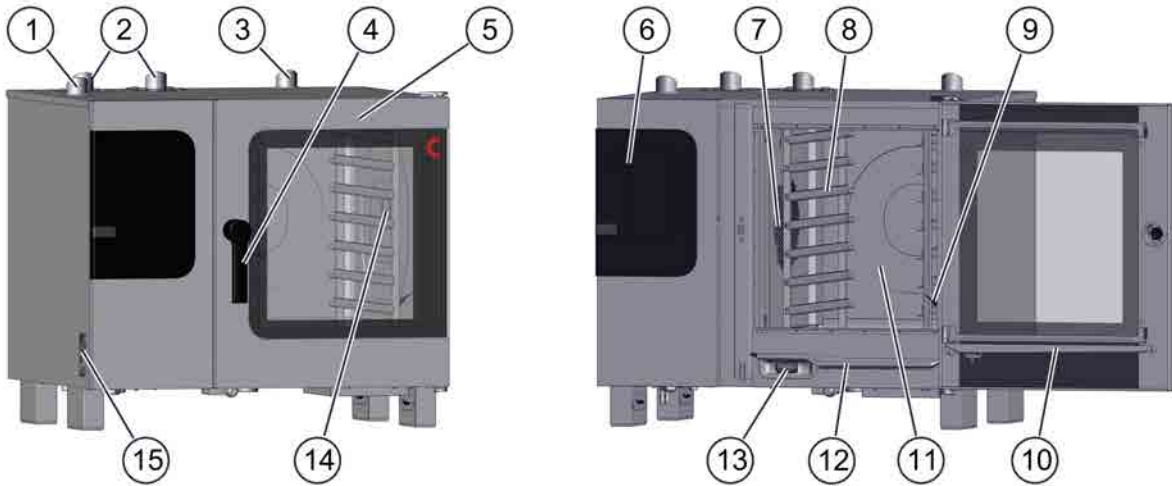

No.	Designation	Function
1	Ventilation port	<ul style="list-style-type: none"> ▪ Draws in ambient air in order to remove moisture from the cooking compartment ▪ Compensates for pressure fluctuations inside the cooking compartment
2	Exhaust vents	Lets hot steam escape
3	Exhaust outlet	Discharges hot exhaust gases
4	Door handle	<ul style="list-style-type: none"> ▪ Used to open and close the appliance door ▪ Cracked-open position for safely opening the appliance ("safety lock") ▪ Closing-shut function ▪ Antibacterial material with silver ions ("HygienicCare")
5	Appliance door	<ul style="list-style-type: none"> ▪ Seals the cooking compartment ▪ When opened, it can be slid backwards along the appliance's side in order to save space ("disappearing door") (optional)
6	Control panel	<ul style="list-style-type: none"> ▪ Used to operate the appliance ▪ Antibacterial ("HygienicCare")
7	Suction panel	<ul style="list-style-type: none"> ▪ Used to distribute heat uniformly within the cooking compartment ▪ Separates the fan compartment from the cooking compartment
8	Rack	Used to hold standard-size food containers
9	Core temperature probe, optional sous vide probe (can be externally inserted)	Used to measure the food's internal temperature
10	Door drip tray	Collects the condensate that runs down the inside of the appliance door
11	Cooking compartment	Is where food is placed while it is being cooked

No.	Designation	Function
12	Appliance drip tray	Collects liquids and condensate dripping from the cooking compartment
13	Pullout spray head	<ul style="list-style-type: none">▪ Meant exclusively for rinsing the cooking compartment with water▪ Is retracted automatically into its holder after being used▪ Antibacterial ("HygienicCare")
14	Oven light	<ul style="list-style-type: none">▪ Illuminates the cooking compartment▪ Program-controlled
15	Nameplate	Used to identify the appliance

2.3 Control Panel Layout and Functions

Control panel layout and parts in easyTouch

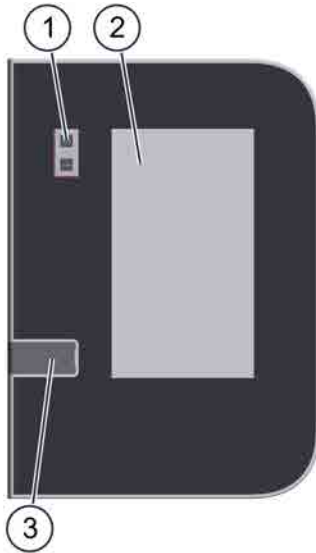

No.	Designation	Function
1	ON/OFF appliance switch	Used to turn the combi steamer on and off
2	Full-touch display	The appliance's central control interface <ul style="list-style-type: none"> ▪ Used by touching the icons on the full-touch display ▪ Status indicators
3	USB port	Used to plug in a USB stick

Control panel layout and parts in easyDial

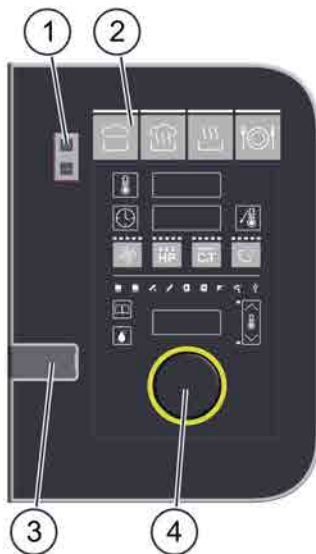

No.	Designation	Function
1	ON/OFF appliance switch	Used to turn the combi steamer on and off
2	Control panel	The appliance's central control interface <ul style="list-style-type: none"> ▪ Buttons used to enter cooking programs ▪ Displays used to indicate configured values ▪ Prompt indicators for the operator
3	USB port	Used to plug in a USB stick
4	C-Dial	Used to set cooking parameters by turning and pressing the encoder.

3 For Your Safety

Purpose of this section

The purpose of this section is to provide you with all the information you will need in order to safely work with/on the combi steamer without putting yourself and others at risk.

Read this section very carefully!

Contents

This section covers the following subjects:

	Page
Basic Safety Instructions	22
Your Combi Steamer's Intended Use	23
Warning Labels on the Combi Steamer	25
Overview of Hazards	28
Hazards and Safety Measures During Operation	30
Hazards and Safety Measures During Cleaning	37
Hazards and Safety Measures During Maintenance	42
Safety Devices	43
Staff and Work Area Requirements	45
Personal Protective Equipment	46



3.1 Basic Safety Instructions

Purpose of these instructions

The purpose of these instructions is to ensure that everyone working with and on the combi steamer will be fully aware of all the risks, hazards, and safety requirements involved and will observe the warnings in the operating manual and on the combi steamer. Failure to follow these instructions may result in death, injury, or property damage.

Customer documentation manuals

Follow the instructions below:

- Fully read the “For Your Safety” section, as well as the section that applies to the way you will be interacting with the combi steamer.
- Keep the customer documentation manuals handy at all times so that you can look up any required information.
- If you transfer the combi steamer to a new owner, make sure to give the new owner the customer documentation manuals as well.

Working with/on the combi steamer

Follow the instructions below:

- Only people who meet all the requirements specified in this operating manual should be allowed to use and otherwise work with/on the combi steamer.
- Only use the combi steamer for its intended use as described in this manual. Never, under any circumstance, use the combi steamer for other purposes, even if they seem obvious.
- Observe all the safety measures specified in this operating manual and on the combi steamer. This applies especially to wearing the required personal protective equipment.
- Make sure to always stay in the specified work areas when working with/on the combi steamer.
- Do not make any alterations to the combi steamer. This includes removing components and adding components that have not been expressly approved. Above all, however, make sure not to disable any safety devices or guards.

For more information...

Related subjects

▷ Your Combi Steamer’s Intended Use	23
▷ Warning Labels on the Combi Steamer	25
▷ Overview of Hazards	28
▷ Hazards and Safety Measures During Operation	30
▷ Hazards and Safety Measures During Cleaning	37
▷ Safety Devices	43
▷ Personal Protective Equipment	46



3.2 Your Combi Steamer's Intended Use

The combi steamer's intended use

- The combi steamer has been designed and built exclusively for cooking a variety of food in standard-size food containers (steam table pans, sheet pans, etc.). Steam, convection, and combi-steam (steam superheated without pressure) are used for this purpose.
- The food containers can be made of stainless steel, ceramic, plastic, aluminum, enameled steel, or glass. Glass food containers must not be damaged.
- The combi steamer is intended exclusively for professional commercial use.

Limitations on use

The combi steamer should not be used to heat up the following materials:

- Dry powders or granular products
- Readily flammable substances or objects with a flashpoint lower than 518 °F, such as readily flammable oils, fats, and plastics
- Food in sealed cans

Staff requirements

- The combi steamer must be operated exclusively by staff meeting the specified requirements. For the corresponding training and qualifications requirements, please refer to "*Staff and Work Area Requirements* on page 45."
- All staff must be familiar with the risks, hazards, and rules involved in handling heavy loads.

Requirements concerning the combi steamer's functional capability

- Do not operate the combi steamer unless it has been properly transported, set up, installed, and placed into operation as indicated in the installation manual and the person responsible for placing it into operation has confirmed this.
- The combi steamer should only be used if all safety devices and guards are present, working properly, and correctly locked in place.
- All manufacturer specifications concerning how to run and service the combi steamer must be observed.
- The load placed inside the combi steamer must never exceed the maximum permissible loading weight; please refer to "*Combi Steamer Loading Capacity* on page 52".

Requirements concerning the combi steamer's surroundings

Required combi steamer surroundings

- Ambient temperature between 40 °F and 95 °F
- No toxic or potentially explosive atmospheres
- Do not use or store gasoline or other flammable vapors, gases, or liquids in the vicinity of a combi steamer
- Dry kitchen floor in order to reduce the risk of accidents occurring

Required installation location characteristics

- No fire alarms or sprinkler system directly above the appliance
- No flammable materials, gases, or liquids above, on, under, or close to the appliance

Limitations on use

- When used outdoors, the appliance must be protected from rain and wind
- Do not shift or move the appliance during operation

Prerequisites for cleaning

- Only use the cleaning agents approved by the manufacturer.
- Do not use a pressure washer to clean the appliance.
- Do not use a water jet to clean the outside of the appliance. Do not use the pullout spray head's water jet for anything other than cleaning the cooking compartment.
- Do not use bases or acids to clean the combi steamer and make sure it is not exposed to acid fumes. The only exception is when the cooking compartment and the boiler are descaled by an authorized service company following the manufacturer's instructions.

3.3 Warning Labels on the Combi Steamer

Stationary base

The term “stationary base” refers to a stationary work table or stand for the combi steamer. These bases are not intended to move and accordingly do not feature any components that would enable them to do so.

Moving base

The term “moving base” refers, for example, to a work table or stand on casters or to a stacking kit with casters for the combi steamer.

Warning label locations on the appliance



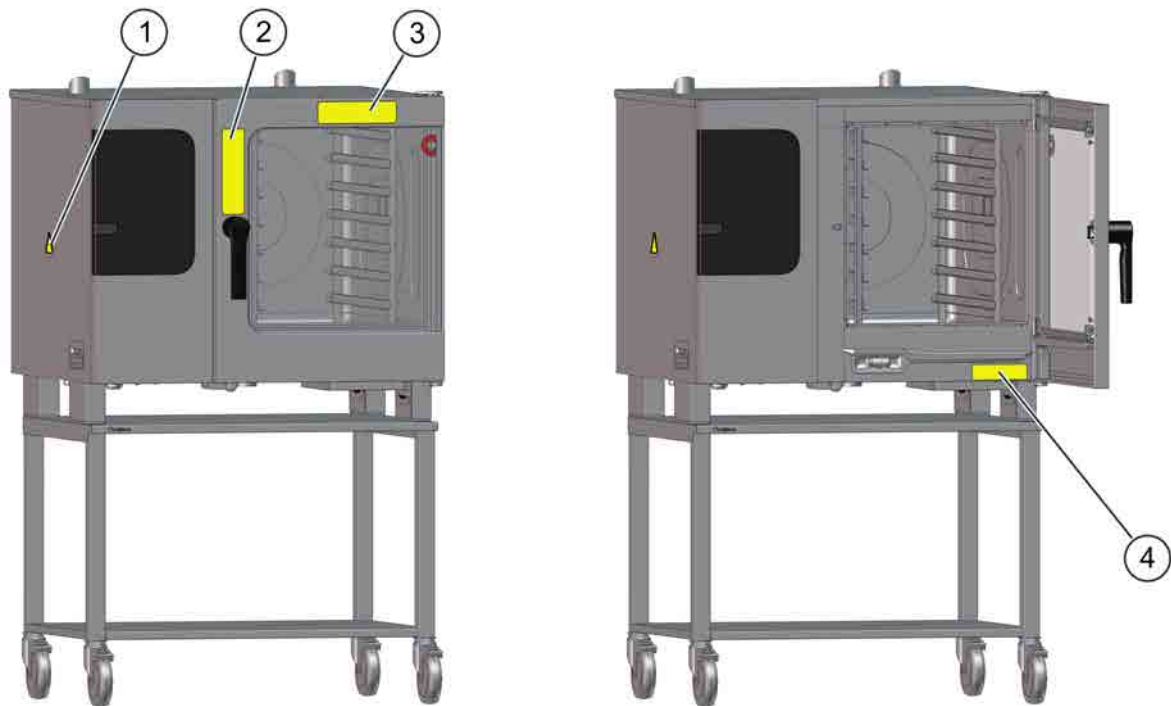



The figure below shows a size 6.10 electrical combi steamer with a moving base used as an example representing all table-top models:



Required warning labels on the appliance

The following warning labels must always be clearly visible on the combi steamer at the locations shown in the previous figure.

Location	Warning label	Description
1 and 4		<p>WARNING To reduce the risk of electric shock, do not remove or open cover. No user serviceable parts inside. Refer servicing to qualified personnel. Disconnect power supply before servicing.</p> <p>AVERTISSEMENT Afin de réduire le risque d'électrocution, ne pas retirer ou ouvrir le capot. Aucune pièce réparable ne se trouve à l'intérieur. Confier le dépannage à du personnel qualifié. Débrancher l'alimentation électrique avant réparation.</p>

Location	Warning label	Description
2		Hot steam warning There is a risk of scalding posed by the hot steam coming out when the appliance door is opened.
2		Hot liquid warning Risk of scalding when liquid food is spilled. This hazard exists when liquids, or food that becomes liquefied during cooking, are placed on the upper rack levels. Rack levels located above the operator's field of view must never be used to hold liquids or food that will become liquefied.
2		Combi steamer tip-over hazard warning for when the combi steamer is placed on a base with casters There is a risk of the combi steamer toppling over when being moved. Exercise extreme caution when moving the combi steamer. When moving the combi steamer, look out for obstacles and uneven surfaces.
2		Appliance connection damage and disconnection warning for when the combi steamer is placed on a base with casters There is a risk of the appliance's connections being damaged or disconnected when the combi steamer is moved. Exercise extreme caution when moving the combi steamer and take the connections' length into account. Every time after moving it, secure the combi steamer so that it cannot roll away by accident.
3		CAUTION Do not open combi door during smoking. Outside air entering the combi may cause wood bisquettes to ignite. WARNING The use of improper materials for smoke mode may result in equipment damage or hazards or may shorten the life of the combi. Only use materials listed for smoke mode in the operator's manual.
3		CAUTION Door(s) and handle(s) may be hot. ATTENTION Porte(s) et poignée(s) chaudes

Required warning labels on the optional transport trolley

The following warning labels must always be clearly visible on the transport trolley at the location shown in the figure below.

Location 5

Warning label

Description



Hot liquid warning
Risk of scalding when liquid food is spilled. This hazard exists when liquids, or food that becomes liquefied during cooking, are placed on the upper rack levels. Rack levels located above the operator's field of view must never be used to hold liquids or food that will become liquefied.



Transport trolley tip-over hazard warning
There is a risk of the transport trolley toppling over when being moved. Exercise extreme caution when moving the transport trolley. When moving the transport trolley, look out for obstacles and uneven surfaces.

3.4 Overview of Hazards

General rules on how to deal with hazards and safety measures

The combi steamer has been designed in such a way as to ensure that users will be protected from all hazards that can be reasonably prevented using design-based measures.

However, the combi steamer's intended use entails a series of residual risks that will require you to take precautions in order to avoid them. The safety devices and guards on the appliance may protect you from some of these risks to a certain extent. However, in order for the safety devices and guards to protect you, you must make sure that they are in place and working properly.

Following is a description of these residual risks and what kinds of hazards they pose.

Danger areas

The figure below shows a size 6.10 gas combi steamer used as an example representing all table-top models:

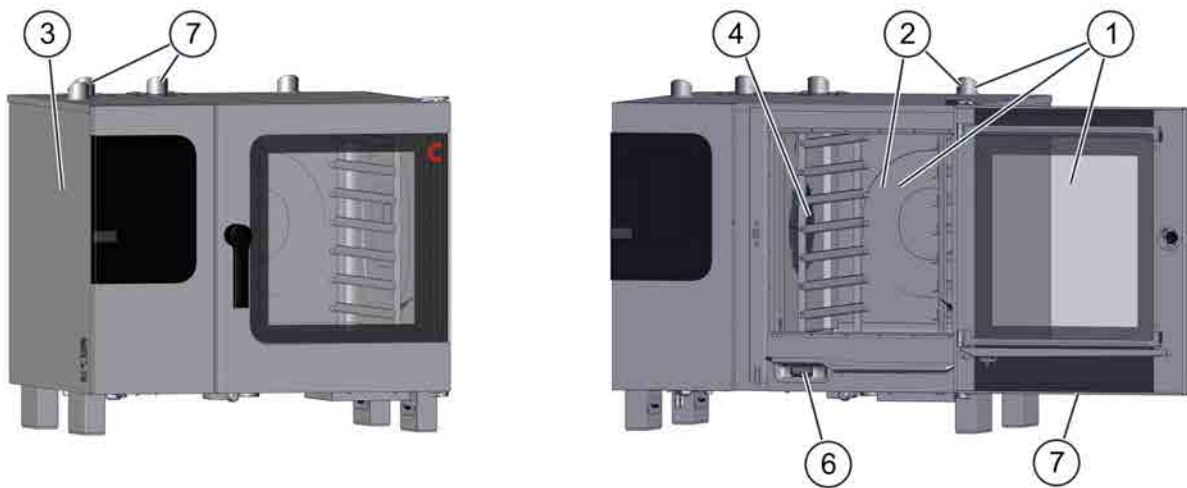

Heat build-up (1)

During operation, the following combi steamer areas will become hot: the inside of the cooking compartment, the inside of the appliance door, and the vents on top of the appliance. This poses the following risks:

- Fire hazard posed by the combi steamer's heat output.
- Risk of burns posed by hot surfaces on the outside and inside of the combi steamer, as well as by hot appliance parts, food containers,, and other cooking accessories on the inside.
- Risk of burns posed by the vents on top of the appliance.
- Risk of burns posed by hot accessories used for cooking if they are removed from the appliance after cooking and put down elsewhere. This applies to mobile shelf racks in particular.

Hot steam (2)

The combi steamer generates hot steam that will escape when the appliance door is opened and that will come out through the exhaust vents on top of the combi steamer when the appliance door is closed. This poses the following risks:

- Risk of scalding posed by hot steam when the appliance door is opened. The appliance door and its safety lock will protect you from hot steam if you use the cracked-open position when opening the door and generally make sure that the door is intact. Exercise extreme caution if you are opening the appliance door in a setup in which the upper edge of the door is below your field of view, as will be the case when using a stacking kit.
- Risk of scalding posed by hot steam and fat whenever water is sprayed into hot fat.
- Risk of burns posed by high temperatures on the vents found on top of the appliance.

Hot liquids

The purpose of the combi steamer is to cook food inside it. This food can also be liquid or become liquefied during the cooking process. This poses the following risks:

- Risk of scalding posed by hot liquids that may be spilled if handled incorrectly.

Live parts (3)

The combi steamer has live parts in it. This poses the following risks:

- Hazard posed by live parts when the cover is not in its place.
- Electric shock hazard when the combi steamer's outside is cleaned using a spray head.

Fan (4)

The combi steamer has either one fan or two fans inside, depending on the appliance size. This poses the following risks:

- Risk of hand injuries caused by the fan behind the suction panel in the cooking compartment when the suction panel is not properly installed in its place.

Contact with cleaning agents

The combi steamer needs to be cleaned with special cleaning agents. This poses the following risks:

- Hazard posed by cleaning agents (some of them caustic).

Parts moving against each other (5)

Hands and fingers can get pinched, crushed, cut, or severed while performing various actions, such as closing/opening the appliance door and cleaning the appliance door.

Spray head (6)

The combi steamer comes with a spray head that can pose a number of hazards:

- Risk of scalding if the spray head is used to spray water into the hot cooking compartment, e.g., to clean it.
- Risk of scalding if the combi steamer is in the immediate vicinity of appliances used to heat up liquid fat and the spray head is used to spray water into these appliances.
- Risk of scalding whenever there is bakeware containing liquid fat inside the cooking compartment and the spray head is used to spray water into it.
- Electric shock hazard posed whenever the combi steamer's outside is cleaned using the spray head.

Break in the cold chain

The cold chain for refrigerated food can be broken if food is placed inside the cooking compartment too early (e.g., if a wrong cooking program start time is pre-selected) or if the cooking process is interrupted. This poses the following risks:

- A hazard for your guests in the form of microbiological food contamination.

Gas (7)

This combi steamer is a gas appliance, which entails additional hazards:

- Explosion hazard if the gas line is faulty or leaking
- Risk of burns posed by the hot exhaust gas coming out of the exhaust outlet
- Fire hazard posed by the hot exhaust gas above the appliance
- Risk of lack of oxygen in the kitchen if the burner is not set up properly, if there is insufficient combustion air, and/or if exhaust gas is not properly discharged away from the kitchen



3.5 Hazards and Safety Measures During Operation

Safety hazard: heat – hot surfaces

Risk / hazard	Where and in which situations will the risk/hazard exist?	What to do
Risk of burns posed by hot surfaces	On the outside of the appliance door	Do not touch the surfaces for extended periods of time
	Inside the entire cooking compartment. This includes all parts that are or have been inside the compartment during cooking, such as:	Wear the required personal protective equipment, especially protective gloves
	<ul style="list-style-type: none"> ▪ Racks ▪ Suction panel ▪ Core temperature probe ▪ Bakeware, sheet pans, shelf grills, etc. ▪ Smoker heater and smoker box 	
	On the inside of the appliance door	
	On top of electrical appliances :	
<ul style="list-style-type: none"> ▪ Exhaust vents ▪ Ventilation port 		
	On top of gas appliances :	
	<ul style="list-style-type: none"> ▪ Exhaust vents ▪ Exhaust outlet ▪ Ventilation port 	

Safety hazard: heat – hot steam

Risk / hazard	Where and in which situations will the risk/hazard exist?	What to do
Risk of scalding posed by hot steam	In front of the appliance if the appliance door is not intact	Check the appliance door's condition
	In front of the appliance when the cooking compartment is cooled down with the "Cool down" function	<ul style="list-style-type: none"> ▪ Step away from the appliance, as hot steam will come out through the open appliance door ▪ Do not put your head inside the cooking compartment
	When the appliance door is opened	<ul style="list-style-type: none"> ▪ Use the appliance door's cracked-open position ▪ Do not put your head inside the cooking compartment ▪ Check that the cracked-open position works properly
	For electrical appliances :	Do not move any body parts close to the exhaust vent
	<ul style="list-style-type: none"> ▪ Above the exhaust vent 	
In gas appliances :	Do not move any body parts close to air vents or exhaust outlets	
	<ul style="list-style-type: none"> ▪ Above air vents and exhaust outlets 	

Safety hazard: heat

Risk / hazard	Where and in which situations will the risk/hazard exist?	What to do
Risk of scalding posed by hot liquid	<ul style="list-style-type: none"> ▪ Inside the appliance ▪ Outside the appliance 	<p>Use bakeware with matching standard dimensions only (steam table pans, sheet pans, etc.)</p> <hr/> <p>Do not exceed the maximum load weight</p> <hr/> <p>Slide in the food containers correctly according to the rules on Page 49 for size X.10 appliances or the rules on Page 50 for size X.20 appliances, as applicable.</p> <hr/> <p>When handling bakeware containing liquid food or food that will become liquefied during cooking, make sure to only slide the bakeware into fully visible rack levels, as well as to pull it out in a completely horizontal position</p> <hr/> <p>Wear appropriate protective gloves</p> <hr/> <p>When using racks</p> <ul style="list-style-type: none"> ▪ Lock the racks correctly in place <hr/> <p>When using mobile shelf racks and transport trolleys:</p> <ul style="list-style-type: none"> ▪ Engage the mobile shelf rack latch when loading or moving the transport trolley ▪ Lock the transport trolley's tray guard bar in place when moving the transport trolley ▪ If you will be using the transport trolley to move hot liquids, make sure that the corresponding bakeware is covered. ▪ Make sure that the transport trolley does not topple over. The transport trolley is at risk of toppling over when being moved across an inclined surface, when it runs into an obstacle, or when it is top-heavy.

Safety hazard: heat – smoker operation

Risk / hazard	Where and in which situations will the risk/hazard exist?	What to do
Risk of burns caused by the ignition of smoking bisquettes and smoke; risk of smoke inhalation	<ul style="list-style-type: none"> ▪ Whenever the appliance door is opened and the air that flows into the cooking compartment causes the smoking bisquettes and/or the smoke to combust explosively ▪ Whenever smoke is inhaled while opening the appliance door 	Never open the appliance door during smoking
Risk of burns and fire hazard posed by flying sparks	<ul style="list-style-type: none"> ▪ Whenever air comes into contact with hot smoking bisquettes 	<ul style="list-style-type: none"> ▪ Do not remove the smoker box's cover until the box has cooled down completely in a fireproof location that is not exposed to wind. ▪ Always keep the cover on the smoker box during smoking. ▪ Do not dispose of ashes or used bisquettes until they are cold

Safety hazard: heat – other

Risk / hazard	Where and in which situations will the risk/hazard exist?	What to do
Fire hazard posed by the appliance's heat output	Whenever flammable materials, gases, or liquids are stored on or next to the appliance.	Do not store any flammable materials, gases, or liquids on or next to the appliance.
Risk of scalding posed by water being sprayed	Whenever there is bakeware containing liquid fat inside the cooking compartment and water is sprayed into it	Do not spray water into liquid fat

Safety hazard: microbiological food contamination

Risk / hazard	Where and in which situations will the risk/hazard exist?	What to do
Risk of microbiological food contamination	When the food's cold chain is broken by putting the food in the cooking compartment prematurely	Make sure not break the cold chain: <ul style="list-style-type: none"> ▪ Do not use the cooking compartment to temporarily store the food being cooked ▪ Low-temperature cooking (<150 °F) should be performed by qualified staff only.
	When the cooking process is manually interrupted	<ul style="list-style-type: none"> ▪ Never interrupt the cooking process on purpose ▪ Do not use the cooking compartment to temporarily store the food being cooked
	When the cooking process is interrupted by a power outage	Once the appliance starts up again, take into account the time that will be necessary to restart the cooking process while taking the food's condition into account
Risk of microbiological food contamination in hot ambient conditions within a temperature range of 85 to 150 °F.	When rethermalizing, using low-temperature cooking, or keeping food warm and then proceeding to move cold food into the appliance during the process.	Do not move cold food into the appliance while rethermalizing food, cooking food at low temperatures, or keeping food warm
	Whenever using low-temperature cooking or keeping food warm in general.	<ul style="list-style-type: none"> ▪ Low-temperature cooking (<150 °F) should be performed by qualified staff only. ▪ Reduce the amount of microorganisms on the food before cooking it at low temperatures (by searing it, for example).

Safety hazard: moving appliances on bases with casters

Risk / hazard	Where and in which situations will the risk/hazard exist?	What to do
Pinch point hazard (for multiple body parts)	When appliances are being moved on a base with casters	<ul style="list-style-type: none"> ▪ Do not pull the base with casters forward unless you are cleaning the combi steamer case or the floor/surface below the appliances, in which case you should make sure not to pull it forward by more than the 20" allowed by the attached retaining element ▪ Check to make sure that the retaining element is attached before moving the base ▪ If the drain pipe is connected with a fixed connection, disconnect the pipe before moving the appliance ▪ De-energize the appliance before moving it ▪ Make sure to always lock the casters' wheels when the appliances are running ▪ Every day before using the appliances, check to make sure that the casters' wheels are locked
Pinch point hazard (hand and foot hazard)		
Risk of scalding posed by hot wastewater		
Risk of scalding posed by hot, liquid food		
Risk of electric shock posed by live parts		
Gas explosion hazard		
Skin and eye irritation hazard as a result of contact with cleaning agents		

Safety hazard: electricity

Risk / hazard	Where and in which situations will the risk/hazard exist?	What to do
Risk of electric shock posed by live parts	If the appliances are on a base with casters and the electrical connection breaks as a result of the appliances rolling away by accident	<ul style="list-style-type: none"> ▪ Before running the appliance, check to make sure that the retaining element designed to limit how much the base can move with the appliance is attached. ▪ Make sure to always lock the casters' wheels when the appliances are running ▪ Every day before using the appliances, check to make sure that the casters' wheels are locked

Safety hazard: water

Risk / hazard	Where and in which situations will the risk/hazard exist?	What to do
Fall hazard as a result of floors being wet	If the appliances are on a base with casters and the water connection breaks as a result of the appliances rolling away by accident	<ul style="list-style-type: none"> ▪ Before running the appliance, check to make sure that the retaining element designed to limit how much the base can move with the appliance is attached. ▪ Make sure to always lock the casters' wheels when the appliances are running ▪ Every day before using the appliances, check to make sure that the casters' wheels are locked

Safety hazard: gas

Risk / hazard	Where and in which situations will the risk/hazard exist?	What to do
Gas explosion hazard	Whenever the appliance is moved	<p>Do not move the appliance during operation</p> <p>In the case of appliances on a base with casters that are connected using a flexible connecting hose:</p> <ul style="list-style-type: none"> ▪ Do not pull the base forward unless you are cleaning the appliance or the floor/surface underneath the appliance, in which case you should make sure not to pull it beyond its limit. This limit (usually 20") will be defined by the retaining element used to mechanically secure the appliance. ▪ Make sure to always lock the casters' wheels when the appliance is running ▪ Every day before using the appliances, check to make sure that the casters' wheels are locked
Suffocation hazard due to lack of oxygen	At the appliance's installation location	<ul style="list-style-type: none"> ▪ Do not block or otherwise obstruct the area below the appliance ▪ Operate the appliance in windless environments only ▪ Make sure that the installed ventilation equipment works properly and follow all the ventilation rules specified by the installation technician. ▪ Arrange for the appliance to be serviced once a year

Safety hazard: mechanical appliance components

Risk / hazard	Where and in which situations will the risk/hazard exist?	What to do
Risk of injury posed by rotating fan	Whenever the cooking compartment is cooled down with the "Cool down" function while the appliance door is open and the fan is accessible due to the suction panel not being in place.	Make sure that the suction panel is locked in its place
Slip hazard posed by drained condensate	In front of the appliance	Always keep the floor around the appliance dry
Pinch point hazard (hand hazard)	When moving the transport trolley	Always use the transport trolley's handlebar when moving the transport trolley
	When sliding the mobile shelf rack in	Always use the mobile shelf rack's handles to slide the rack in and out of the cooking compartment

3.6 Hazards and Safety Measures During Cleaning

Safety hazard: cleaning agents

Risk / hazard	Where and in which situations will the risk/hazard exist?	What to do
Skin, eye, and respiratory tract irritation hazard as a result of contact with cleaning agents and their vapors	During fully automatic cleaning: In front of the appliance door	<ul style="list-style-type: none"> ▪ If using the canisters, do not open the appliance door during the fully automatic oven cleaning process ▪ If using single-measure dispensing, do not open the appliance door during the fully automatic oven cleaning process until asked to do so by the software
	During all cleaning activities	<ul style="list-style-type: none"> ▪ Do not let your eyes or skin come into contact with cleaning agents ▪ Do not heat up the appliance when there are cleaning agents in it. Doing so is only permitted when running the semi-automatic or fully automatic cleaning process under supervision. ▪ Do not spray cleaning agents into the appliance until asked to do so or unless the cooking chamber temperature is equal to or lower than 140 °F ▪ Do not inhale the spray mist ▪ Wear the required personal protective equipment
	Whenever handling the cleaning agent canisters	Wear the required personal protective equipment
	Whenever handling the bottles for single-measure dispensing	Wear the required personal protective equipment
	Whenever using aggressive cleaning agents	Only use the cleaning agents specified under <i>Cleaning Agents</i> on page 95.

Safety hazard: microbiological food contamination

Risk / hazard	Where and in which situations will the risk/hazard exist?	What to do
Risk of food being contaminated by cleaning agents	Whenever cleaning agent and rinse aid single-measure dispensing bottles are handled improperly.	<ul style="list-style-type: none">▪ Make sure that the work surface does not come into contact with cleaning agent or rinse aid▪ Do not put empty single-measure dispensing bottles down on the work surface, as drops of cleaning agent or rinse aid may run down along the outside of the bottles
Risk of food being contaminated by cleaning agents	Whenever the cooking compartment is not completely rinsed out after semi-automatic cleaning in appliances without a pullout spray head	Instead of the pullout spray head, use an external water jet to rinse out the appliance or rinse the cooking compartment, the accessories, and the area behind the suction panel thoroughly with plenty of water and wipe them clean with a soft cloth

Safety hazard: heat

Risk / hazard	Where and in which situations will the risk/hazard exist?	What to do
Risk of burns posed by hot surfaces	<p>On the outside of the appliance door</p> <p>Inside the entire cooking compartment. This includes all parts that are or have been inside the compartment during cooking, such as:</p> <ul style="list-style-type: none"> ▪ Racks ▪ Suction panel ▪ Core temperature probe ▪ Bakeware, sheet pans, shelf grills, etc. ▪ Smoker heater and smoker box <p>On the inside of the appliance door</p> <hr/> <p>On top of electrical appliances:</p> <ul style="list-style-type: none"> ▪ Exhaust vents ▪ Ventilation port <hr/> <p>On top of gas appliances:</p> <ul style="list-style-type: none"> ▪ Exhaust vents ▪ Exhaust outlet ▪ Ventilation port 	<ul style="list-style-type: none"> ▪ Before performing any cleaning work, wait until the cooking compartment has cooled down to a temperature lower than 140 °F or cool it down using the “Cool down” function ▪ Wear the required personal protective equipment, especially protective gloves
Risk of scalding posed by hot steam whenever water is sprayed into the hot cooking compartment	Inside the entire cooking compartment	<ul style="list-style-type: none"> ▪ Before starting to clean the unit, wait until the cooking compartment has cooled down to a temperature lower than 140 °F or cool it down using the “Cool down” function ▪ Wear the required personal protective equipment, especially protective gloves
Risk of scalding posed by hot steam	In front of the appliance when the cooking compartment is cooled down with the “Cool down” function	<ul style="list-style-type: none"> ▪ Step away from the appliance, as hot steam will come out through the open appliance door ▪ Do not put your head inside the cooking compartment
Risk of scalding posed by water being sprayed	Whenever bakeware containing liquid fat is inside the cooking compartment and water is sprayed into it	Do not spray water into liquid fat

Safety hazard: moving appliances on bases with casters

Risk / hazard	Where and in which situations will the risk/hazard exist?	What to do
All the risks and hazards listed below	When appliances are being moved on a base with casters	<ul style="list-style-type: none"> ▪ If the drain pipe is connected with a fixed connection, disconnect the pipe before moving the appliance ▪ Before moving the appliance (to clean the combi steamer's case or the floor, for example), check to make sure that the retaining element designed to limit how much the base can move with the appliance is attached. ▪ When moving the appliance, make sure not to roll over any connection lines (electrical, gas, and water)
Pinch point hazard (for multiple body parts)	When appliances are being moved on a base with casters	<ul style="list-style-type: none"> ▪ Pay attention to the utility and hose connections. ▪ Use at least two people to move the appliance
Pinch point hazard (hand and foot hazard)	When appliances are being moved on a base with casters	Keep the appliance doors shut
Risk of scalding posed by hot wastewater	When appliances are being moved on a base with casters	<ul style="list-style-type: none"> ▪ Let the appliances cool down ▪ Immediately wipe or mop up any water that has leaked ▪ Wear appropriate protective clothing
Risk of scalding posed by hot, liquid food	When appliances are being moved on a base with casters	Do not move appliances if there is any food still in them
Risk of electric shock posed by live parts	When appliances are being moved on a base with casters	Pay attention to the utility and hose connections.
Gas explosion hazard	When appliances are being moved on a base with casters	Pay attention to the gas supply line
Skin and eye irritation hazard as a result of contact with cleaning agents	When appliances are being moved on a base with casters	<ul style="list-style-type: none"> ▪ Make sure that the utility and hose connections are long enough ▪ When moving the base, keep the cleaning agent canisters closed
Trip hazard as a result of utility and hose connections routed in the open	When cleaning behind appliances that have been pulled forward	Exercise caution when performing maintenance work
Fall hazard as a result of floors being wet with wastewater	<ul style="list-style-type: none"> ▪ When cleaning behind appliances that have been pulled forward ▪ In front of the appliance 	<ul style="list-style-type: none"> ▪ Immediately wipe or mop up any water that has leaked ▪ Make sure that the utility and hose connections are long enough
Fall hazard as a result of floors being wet with cleaning agents	<ul style="list-style-type: none"> ▪ When cleaning behind appliances that have been pulled forward ▪ In front of the appliance 	When moving the appliances, keep the cleaning agent canisters closed

Safety hazard: electricity

Risk / hazard	Where and in which situations will the risk/hazard exist?	What to do
Risk of electric shock due to short circuit	If the appliance comes into contact with water	<ul style="list-style-type: none"> ▪ Do not hose down the outer case ▪ Always keep the USB port closed during cleaning
Risk of electric shock posed by live parts	If the appliances are on a base with casters and the electrical connection breaks as a result of the appliances rolling away by accident	<ul style="list-style-type: none"> ▪ Before running the appliance, check to make sure that the retaining element designed to limit how much the base can move with the appliance is attached. ▪ Make sure to always lock the casters' wheels when the appliances are running ▪ Every day before using the appliances, check to make sure that the casters' wheels are locked

Safety hazard: gas

Risk / hazard	Where and in which situations will the risk/hazard exist?	What to do
Gas explosion hazard	Whenever the appliance is moved	<p>In the case of appliances on a base with casters that are connected using a flexible connecting hose:</p> <ul style="list-style-type: none"> ▪ When cleaning the case or the floor/surface below it, do not pull the appliance forward beyond its limit. This limit (usually 20") will be defined by the retaining element used to mechanically secure the appliance. ▪ Do not pull or otherwise subject the connections to any tension

Safety hazard: mechanical appliance components

Risk / hazard	Where and in which situations will the risk/hazard exist?	What to do
Risk of injury posed by rotating fan	Whenever the cooking compartment is cooled down with the "Cool down" function while the appliance door is open and the fan is accessible due to the suction panel not being in place.	Make sure that the suction panel is locked in its place
Pinch point hazard (hand hazard) and cut/sever hazard (finger hazard)	When opening and closing the double glass door	Exercise caution when performing maintenance work

3.7 Hazards and Safety Measures During Maintenance

Safety hazard: heat

Risk / hazard	Where and in which situations will the risk/hazard exist?	What to do
Risk of burns posed by hot surfaces	On the outside of the appliance door	<ul style="list-style-type: none"> ▪ Before performing any maintenance work, wait until the cooking compartment has cooled down to a temperature lower than 140 °F or cool it down using the “Cool down” function ▪ Wear the required personal protective equipment, especially protective gloves
	Inside the entire cooking compartment. This includes all parts that are or have been inside the compartment during cooking, such as: <ul style="list-style-type: none"> ▪ Racks ▪ Suction panel ▪ Core temperature probe ▪ Bakeware, sheet pans, shelf grills, etc. 	
	On the inside of the appliance door	
	On top of electrical appliances : <ul style="list-style-type: none"> ▪ Exhaust vents ▪ Ventilation port 	
	On top of gas appliances : <ul style="list-style-type: none"> ▪ Exhaust vents ▪ Exhaust outlet ▪ Ventilation port 	

Safety hazard: electricity

Risk / hazard	Where and in which situations will the risk/hazard exist?	What to do
Risk of electric shock posed by live parts	<ul style="list-style-type: none"> ▪ Under the cover ▪ Under the control panel ▪ On the power cable 	<ul style="list-style-type: none"> ▪ Maintenance work under the cover, under the control panel, and on the power cable should be performed exclusively by a qualified electrician from an authorized service company. ▪ Do not remove the cover or control panel

Safety hazard: mechanical appliance components

Risk / hazard	Where and in which situations will the risk/hazard exist?	What to do
Risk of cut injuries posed by sharp edges	When performing maintenance work	<ul style="list-style-type: none"> ▪ Exercise caution when performing maintenance work ▪ Wear personal protective equipment

3.8 Safety Devices

Meaning

The combi steamer features a series of safety devices and guards that protect the user from a variety of hazards. All safety devices and guards must be present and fully functional without fail when the combi steamer is being used.

Location and functions

The figure below shows a size 6.10 electric combi steamer used as an example representing all table-top models:

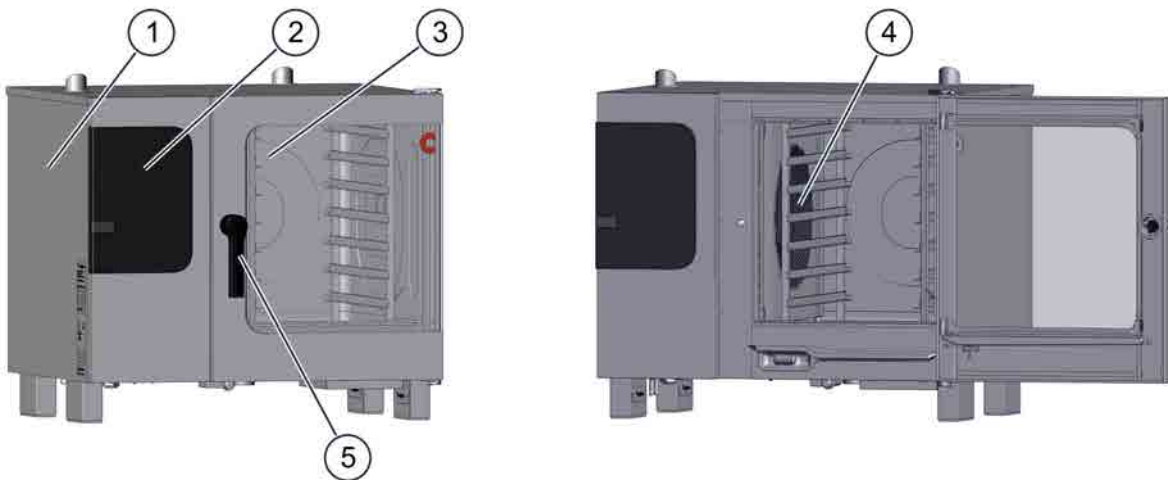

No.	Safety device	Function	Check
1	Cover; can only be removed with tools	<ul style="list-style-type: none"> Prevents staff from accidentally touching live parts Prevents staff from reaching into the moving fan inside the wiring compartment 	Check to make sure that the cover is in its proper place
2	Control panel; can only be removed with tools	Prevents staff from accidentally touching live parts	Check to make sure that the control panel is in its proper place
3	Appliance door with door solenoid switch	<p>Appliance door: Protects the operator and the surroundings from hot steam</p> <p>Door solenoid switch (electrical door sensor):</p> <ul style="list-style-type: none"> Stops/turns off the following when the appliance door is opened: <ul style="list-style-type: none"> Fan (will stop after a few seconds) Heating element Cleaning agent spraying in the fully automatic oven cleaning process Prompts the user to close the appliance door 	<p>Check the pane for scratches, cracks, and other damage on a regular basis and replace it if you detect any damage</p> <p>Test the door solenoid switch with the combi steamer at a low temperature: Procedure:</p> <ul style="list-style-type: none"> Fully open the appliance door Press Start <p>Result: The motor must not start running</p>

No.	Safety device	Function	Check
4	Suction panel inside the cooking compartment; can only be removed with tools	Prevents staff from reaching into the moving fan and ensures proper heat distribution	Please refer to “ <i>Releasing the Suction Panel and Locking it Back in Place</i> ” on page 123”
5	Appliance door cracked-open position	Prevents steam coming out from scalding the operator’s face and hands	With the combi steamer at a low temperature, check the door positions as described in “ <i>Safely Opening and Closing the Appliance Door</i> ” on page 68.”
6 (not shown)	Safety thermostat <ul style="list-style-type: none"> ▪ Boiler ▪ Cooking compartment 	Turns off the appliance if the temperature exceeds the allowable limit	An error code will be output in the event of a fault (Contact a service company that is authorized to reset the safety thermostat)
7 (not shown)	Restart or forced rinsing after power outage if there was cleaning agent inside the appliance when the power went out	Starts the fully automatic oven cleaning process again, from a defined state, after a power outage	None
8 (installed by the customer)	Power disconnection	Used to de-energize the appliance during cleaning, repairs, and maintenance work, as well as in hazardous situations	The operator does not need to check anything.
9 (installed by the customer)	Gas shut-off device	Used to disconnect the appliance from the gas supply during cleaning, repair, and maintenance work, as well as in hazardous situations.	The operator does not need to check anything.
10 (not shown)	Only for setups involving a stand with casters: Retaining element	Limits how much the entire setup (base and appliance) can move from its location	Check to make sure that the retaining element is properly attached



3.9 Staff and Work Area Requirements

Staff requirements

The table below specifies the qualifications needed for each role. Provided that they have the required qualifications, a single person can take over more than one role if necessary.

Role	Required qualifications	Tasks
Cook	<ul style="list-style-type: none"> ▪ Has relevant training ▪ Is familiar with all country-specific food and hygiene laws and regulations ▪ Must maintain documentation as required by HACCP ▪ Has been briefed on how to operate the combi steamer 	Primarily takes care of organizational tasks, such as: <ul style="list-style-type: none"> ▪ Entering cooking profile data ▪ Editing existing cooking profiles in the cookbook ▪ Coming up with new cooking profiles ▪ Configuring the appliance's settings and takes care of all operator tasks as well if necessary.
Operator	<ul style="list-style-type: none"> ▪ Is semi-skilled ▪ Has been briefed on how to operate the combi steamer ▪ Works under supervision ▪ Is familiar with the rules involved in handling heavy loads 	Actually operates the combi steamer, taking care of tasks such as: <ul style="list-style-type: none"> ▪ Putting food into the combi steamer ▪ Starting the cooking profile ▪ Taking out the food once it has been cooked ▪ Cleaning the combi steamer ▪ Changing the racks and other equipment in the combi steamer. For example: switching between racks and mobile shelf racks ▪ Limited maintenance work

Work areas during operation

During operation, the work area for staff is in front of the appliance door.

Work areas during cleaning and maintenance

During cleaning and maintenance, the work area for staff is the entire area occupied by the appliance and its surroundings.

3.10 Personal Protective Equipment

Operation

Task	Tools used	Personal Protective Equipment
Placing food inside / taking food out	None	Wear appropriate work clothes for kitchen work as required by your country-specific standards and regulations, especially: <ul style="list-style-type: none"> ▪ Protective clothing ▪ Heat-resistant gloves ▪ Safety footwear
Handling the core temperature probe	None	Wear appropriate work clothes for kitchen work as required by your country-specific standards and regulations, especially: <ul style="list-style-type: none"> ▪ Protective clothing ▪ Heat-resistant gloves
Removing and installing parts	Tools and equipment necessary for the specific task at hand	Wear the work clothes required for kitchen work by your country-specific standards and regulations, especially: <ul style="list-style-type: none"> ▪ Protective clothing ▪ Heat-resistant gloves ▪ Safety footwear

Cleaning

Task	Cleaning agents used	Personal Protective Equipment
<ul style="list-style-type: none"> ▪ Fully automatic oven cleaning with cleaning agents supplied from connected canisters ▪ Semi-automatic oven cleaning ▪ Manual oven cleaning ▪ Handling spray bottles ▪ Handling cleaning-agent canisters ▪ Preparing ready-to-use solution from concentrate 	<ul style="list-style-type: none"> ▪ ConvoClean forte ▪ ConvoClean new ▪ ConvoCare K (concentrate) 	<p>The protective equipment required will depend on the cleaning agents being used, and may include:</p> <ul style="list-style-type: none"> ▪ Respirator ▪ Safety eyewear ▪ Protective gloves ▪ Protective clothing/apron <p>More detailed specifications regarding this equipment can be found in the EC safety data sheets for the cleaning agent(s) being used. For the latest version of these data sheets, please contact the manufacturer.</p> <p>Always follow the instructions and observe all warnings found on the labels used for the cleaning agent(s).</p>
<ul style="list-style-type: none"> ▪ Fully automatic oven cleaning with single-measure dispensing ▪ Handling bottles for single-measure cleaning agent dispensing 	<ul style="list-style-type: none"> ▪ ConvoClean forte S ▪ ConvoClean new S ▪ ConvoCare S 	
Cleaning the double glass door	Common household glass cleaner	Observe the cleaning agent manufacturer's instructions and other information
Cleaning components and accessories as specified in the corresponding instructions	Common household alkali-free, pH-neutral, odorless dishwashing liquid	Observe the cleaning agent manufacturer's instructions and other information
Cleaning the outside of the appliance case	Common household stainless steel cleaner	Observe the cleaning agent manufacturer's instructions and other information

4 How to Cook with Your Combi Steamer

Purpose of this section

This section shows how you should place food inside your combi steamer. It covers how to handle and use the combi steamer when cooking and what kind of steps you need to follow when cooking or rethermalizing food.

“General Cooking Instructions” provides a step-by-step guide on how to cook and rethermalize food. This section does not explicitly explain how to use the software or the appliance components.

To learn more about how to use the software and its workflows, please consult the combi steamer’s operating instructions.

“Specific Cooking Instructions” goes over specific actions that must be carried out when using the combi steamer and the corresponding accessories.

Contents

This section covers the following subjects:

	Page
Basic Guidelines for Putting Food Into the Combi Steamer	48
General Cooking Instructions	53
Specific Cooking Instructions	65

4.1 Basic Guidelines for Putting Food Into the Combi Steamer

Contents

This section covers the following subjects:

	Page
Placing Food Containers in Size X.10 Appliances	49
Placing Food Containers in Size X.20 Appliances	50
Combi Steamer Loading Capacity	52

4.1.1 Placing Food Containers in Size X.10 Appliances

Steam table pans; half-size wire rack, in U-rails (standard version)

The following figure shows how to set up a steam table pan (12" x 20" x X"), two steam table pans (12" x 10" x X"), and a half-size wire rack (13" x 20") in the U-rails (standard version) in size X.10 appliances:

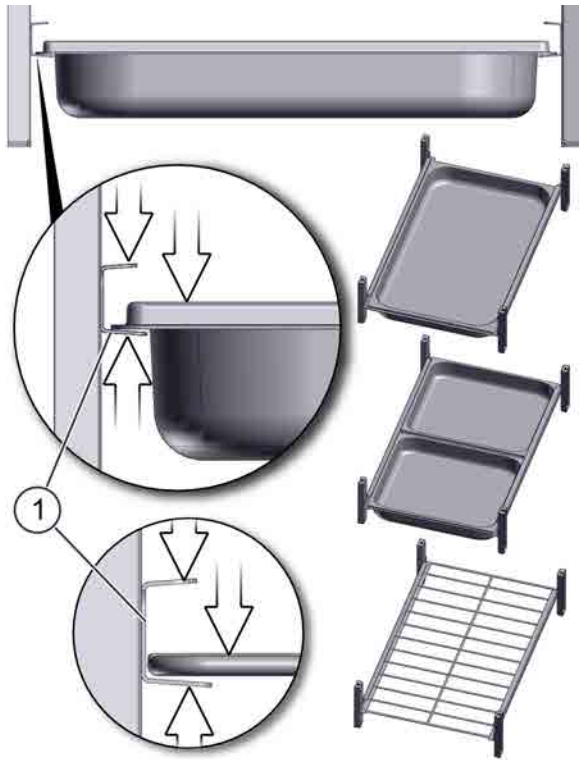

Placement rules

- Bakeware and shelf grills must be slid in **between** the two flanges on the U-rails (1) all the way in.
- The bakeware / shelf grills must be slid in at the same height on both sides.
- **Never** place bakeware or shelf grills on top of a U-rail's upper flange.
- Do not place bakeware on top of shelf grills.

Sheet pans, in U-rails (standard version)

The following figure shows how to set up a half-size sheet pan (13" x 18") and quarter-size sheet pans (13" x 9.5"), in the U-rails (standard version) in size X.10 appliances:

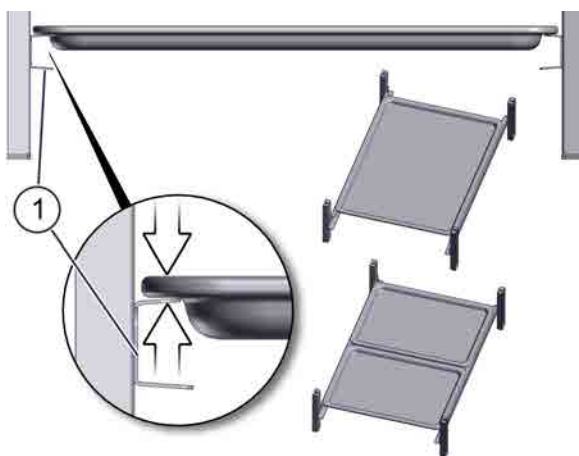

Placement rules

- Sheet pans must be slid in **on top** of the U-rails' (1) **upper** flange (1).
- The sheet pans must be slid in at the same height on both sides.
- Do **not** slide in the sheet pans **between** the two flanges on the U-rails.
- Do not place bakeware on top of sheet pans.

4.1.2 Placing Food Containers in Size X.20 Appliances

Steam table pans; full-size wire rack, in U-rails (standard version)

The following figure shows how to set up two steam table pans (12" x 20" x X") and a full-size wire rack (20" x 26") in the U-rails (standard version) in size X.20 appliances:

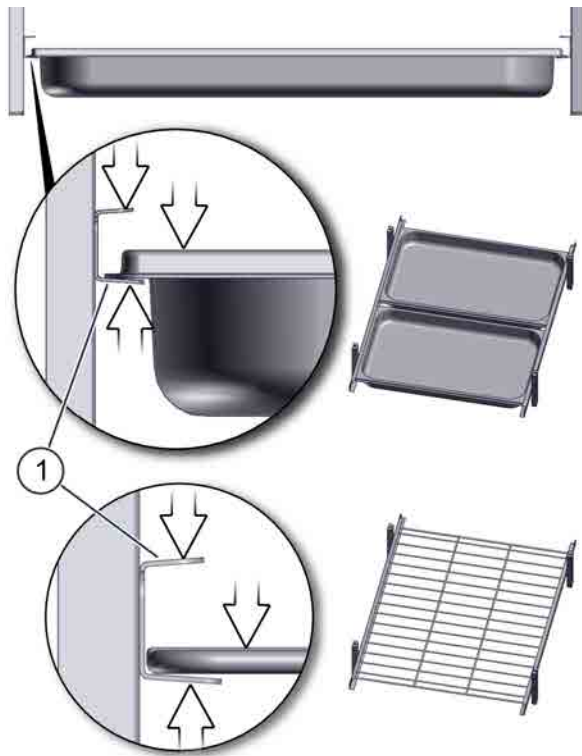

Placement rules

- Bakeware and shelf grills must be slid in **between** the two flanges on the U-rails (1) all the way in.
- The bakeware / shelf grills must be slid in at the same height on both sides.
- **Never** place bakeware or shelf grills on top of a U-rail's upper flange.
- Do not place bakeware on top of shelf grills.

Sheet pans, in U-rails (standard version)

The following figure shows how to set up a full-size sheet pan (18" x 26"), half-size sheet pans (13" x 18"), and quarter-size sheet pans (13" x 9.5"), in the U-rails (standard version) in size X.20 appliances:

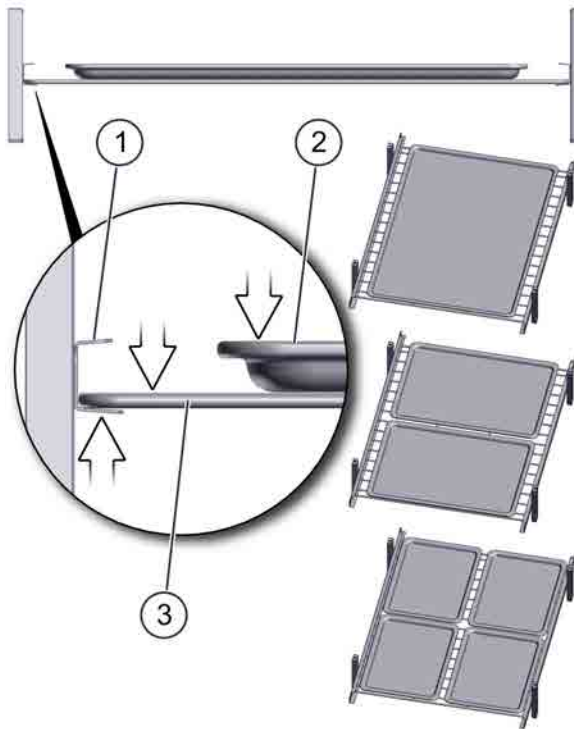

Placement rules

- Shelf grills (3) must be slid in **between** the two flanges on the U-rails (1).
- The shelf grills must be slid in at the same height on both sides.
- **Never** place shelf grills on top of a U-rail's upper flange.
- Do not place steam table pans on top of shelf grills.
- The sheet pans (2) must be placed, one after the other, **on top** of the **shelf grills** that are already in place.
- Do **not** slide in the sheet pans **between** the two flanges on the U-rails.
- Do not place bakeware on top of sheet pans.

4.1.3 Combi Steamer Loading Capacity

Maximum weight that can be placed inside the combi steamer for cooking

C4		6.10	6.20	10.10	10.20
Applies to standard-size food containers (steam table pans, sheet pans etc.)					
Maximum load weight per appliance	[lbs]	66	132	110	220
Maximum load weight per shelf	[lbs]	33	33	33	33

Maximum weight that can be placed inside the combi steamer for rethermalizing

C4		6.10	6.20	10.10	10.20
Applies to standard-size food containers (steam table pans, sheet pans etc.)					
Maximum load weight per appliance	[lbs]	20	40	33	66
Maximum load weight per container (12" x 20" x 2.5" steam table pan)	[lbs]	3.3	3.3	3.3	3.3
Applies to plates					
Maximum number of plates per appliance	[pcs]	15	27	26	48
Maximum load weight per plate	[oz]	12.7	12.7	12.7	12.7

Maximum number of food containers when cooking and rethermalizing food

C4		6.10	6.20	10.10	10.20
Number of shelves (max. shelf spacing: 2.68")	[pcs]	7	7	11	11
Steam table pans (12" x 20" x 1")	[pcs]	6	12	10	20
Steam table pans (12" x 20" x 2.5")	[pcs]	6	12	10	20
Half-size wire racks (13" x 20")	[pcs]	6	-	10	-
Half-size sheet pans (13" x 18") - on wire racks	[pcs]	6	12	10	20
Full-size wire racks (20" x 26")	[pcs]	-	6	-	10
Full-size sheet pans (18" x 26") - on wire racks	[pcs]	-	6	-	10
Frying baskets (12"x20")	[pcs]	6	12	10	20
Plates (optional plate rack) - no wire racks needed	[pcs]	15	27	26	48

Maximum number of food containers when smoking

C4 ES / EB		6.10	6.20	10.10	10.20
Number of shelves (max. shelf spacing: 2.68")	[pcs]	7	7	11	11
Steam table pans (12" x 20" x 1")	[pcs]	5	10	9	18
Steam table pans (12" x 20" x 2.5")	[pcs]	4	8	8	16
Half-size wire racks (13" x 20")	[pcs]	5	-	9	-
Half-size sheet pans (13" x 18") - on wire racks	[pcs]	5	10	9	18
Full-size wire racks (20" x 26")	[pcs]	-	5	-	9
Full-size sheet pans (18" x 26") - on wire racks	[pcs]	-	5	-	9
Frying baskets (12"x20")	[pcs]	5	10	9	18

During smoking, the bottommost rack level must remain free due to the smoker box – do not put anything in it!

4.2 General Cooking Instructions

Contents

This section covers the following subjects:

	Page
Safely Using the Appliance	54
Turning the Combi Steamer On and Off (Lighting Instructions)	57
Cooking Procedures	59
Smoking Procedures	61



4.2.1 Safely Using the Appliance

For your and your employees' safety

Every person (user) must read and understand the contents in the “*For Your Safety* on page 21” section before they work with or on the combi steamer for the first time. In addition, every user must follow the instructions and warnings in said section at all times.

As the combi steamer's owner, or as the owner's employee responsible for the staff who will be using the combi steamer, set the necessary rules and brief all new employees.

Every user must read and understand the safe work rules specified in this section before starting any work and follow them without exception.

Every user must read and understand the risks and hazards described in this section and in the following instructions before starting any work and follow the corresponding safety instructions without exception.

Personal protective equipment for all users

As a user, you must wear the personal protective equipment specified for your work in the “*Personal Protective Equipment* on page 46” section of “*For Your Safety*.”

What to do if you smell gas

If you smell gas, follow the steps below without exception:

- Immediately shut off the gas.
- Thoroughly ventilate the room.
- Do not operate any electrical devices or equipment. Make sure not to cause any sparks.
- Evacuate the building.
- Call the gas company and, if necessary, the fire department on a telephone found outside the hazardous area.

Rules for safely running table-top models

In order to avoid hazards, follow the rules below when running the appliance:

- Make sure to only use your hands when using the appliance's controls (buttons, switches, touchscreens).
- Do not cover, obstruct, or block the exhaust vents, exhaust outlets, or ventilation ports at the top of the appliance or the ventilation openings at the bottom.
- The racks need to be locked in place.
- The food containers must be slid in correctly according to the rules on Page 49 for size X.10 appliances or the rules on Page 50 for size X.20 appliances, as applicable.
- The suction panel needs to be properly locked in place.

Additional rules for the safe use of table-top models on moving bases

In order to avoid hazards, follow the rules below when running appliances on a base with casters:

- Make sure to always lock the front casters' wheels when the appliances are running
- Every day before using the appliances, check to make sure that casters' wheels are locked

Hot surfaces

⚠ WARNING

Risk of burns posed by high temperatures inside the cooking compartment and on the inside of the appliance door

Touching any interior cooking compartment parts, the inside of the appliance door, or any parts that are or were found inside the cooking compartment during cooking may result in burns.

- ▷ Wear appropriate personal protective equipment.

Hot steam

⚠ CAUTION

Risk of scalding posed by hot steam

Hot steam coming out from the appliance may scald your face, hands, feet, and/or legs.

- ▷ When opening the appliance door, make sure to always use the cracked-open position as per the instructions on how to safely open the appliance door. Do not, under any circumstance, stick your head inside the cooking compartment.
- ▷ When cooling down the cooking compartment with the “Cool down” function, step away from the appliance, as hot steam will come out through the open appliance door.

Break in the cold chain

⚠ WARNING

Risk of food being contaminated with microbiological contamination due to the cold chain being broken

The cold chain for refrigerated food can be broken if food is placed inside the cooking compartment too early or if the cooking process is interrupted.

- ▷ When scheduling the time when you will be putting food in the compartment, e.g., when pre-selecting the start time for the cooking program, always make sure that the cold chain will be maintained.
- ▷ Never use the appliance to store food temporarily.
- ▷ Never interrupt the cooking process on purpose.
- ▷ Once the appliance starts up again after a power outage, take into account the time that will be necessary to restart the cooking process while taking the food's condition into account.
- ▷ Low-temperature cooking (< 150 °F) should be performed by qualified staff only.

Microorganism growth at 85 – 150 °F

⚠ WARNING

Risk of food spoilage due to microorganism growth at hot ambient conditions (temperature range of 85 – 150 °F)

Putting cold food into the cooking compartment while rethermalizing food, keeping food warm, or cooking food at low temperatures may cause the cooking compartment temperature to drop to a point where critical microorganism growth may occur.

- ▷ Do not put cold food into the appliance while rethermalizing food, cooking food at low temperatures, or keeping food warm.
- ▷ Reduce the amount of microorganisms on the food before cooking it at low temperatures (by searing it, for example).
- ▷ Low-temperature cooking (< 150 °F) should be performed by qualified staff only.

Leaking gas

⚠ DANGER

Explosion hazard posed by gas leaks

Gas leaks may result in an explosion in the presence of an ignition source.

- ▷ Do not move the appliance during operation.
- ▷ If using an appliance that is placed on a base with casters and is connected using a flexible connecting hose, check to make sure that the retaining element designed to limit how much the base can move with the appliance is attached so that the appliance will be mechanically secured.

Lack of oxygen

▲ DANGER

Suffocation hazard due to lack of oxygen

Inadequate ventilation at the installation location may result in suffocation when the appliance is run.

- ▷ Do not block or otherwise obstruct the area below the appliance.
- ▷ Operate the appliance in windless environments only.
- ▷ Make sure that the installed ventilation equipment works properly and follow all the ventilation rules specified by the installation technician.
- ▷ Arrange for the appliance to be serviced once a year.

4.2.2 Turning the Combi Steamer On and Off (Lighting Instructions)

⚠ For your safety when working with/on the combi steamer



Before starting work, read and understand the rules, risks, and hazards specified in “*Safely Using the Appliance* on page 54” and follow all the corresponding instructions without exception.

Checks before turning on the appliance



Before turning on the combi steamer, check whether the prerequisites below are being met. Do not place the appliance into operation unless all specified prerequisites are met.

- The appliance does not have any obvious damage.
- The accessories being used do not have any obvious damage.
- The installed water connections do not have any obvious damage and are not dripping at any point.
- The drain connection is connected to the appliance and does not have any obvious damage. The end of the drain pipe conveys the wastewater from the appliance into the sewer system. The drain pipe is not dripping at any point and there are no indications of it being clogged.
- The electrical connection does not have any obvious damage and looks like it is safe and working properly when subjected to a visual inspection.
- The gas supply line and the system used to remove exhaust gases do not have any obvious damage and look like they are safe and working properly when subjected to a visual inspection.
- There is nothing being stored inside the cooking compartment and there is nothing inside the cooking compartment other than required cooking accessories (food containers, for example).
- The “*Requirements concerning the combi steamer’s functional capability* on page 23” are being met.
- The “*Requirements concerning the combi steamer’s surroundings* on page 23” are being met.
- All warning labels are at their intended location.

Turning the combi steamer on

- | | | |
|----|---|---|
| 1. |  | Turn the combi steamer on. |
| 2. |  | Check whether the cooking compartment becomes illuminated while the appliance is running its self-diagnostic routine. |
| 3. |  | Wait until the software is ready to start working. |

Turning off the combi steamer when you are done

- | | | |
|----|---|--|
| 1. |  | Carry out all necessary cleaning work as per the cleaning schedule and maintenance schedule. |
| 2. |  | Turn the combi steamer off. |
| 3. |  | Leave the appliance door ajar in order to let moisture escape. |

Turning off the combi steamer before extended periods of nonuse

Before extended periods of nonuse, disconnect the appliance from the water, gas, and power supplies.

4.2.3 Cooking Procedures

⚠ For your safety when working with/on the combi steamer

Before starting work, read and understand the rules, risks, and hazards specified in “*Safely Using the Appliance* on page 54” and follow all the corresponding instructions without exception.

Procedures that you must be familiar with

You will need to be familiar with the following steps:

- Safely Opening and Closing the Appliance Door 68
- Placing Food Inside and Taking It Out 69
- Putting Food Inside the Mobile Shelf Rack 71
- Using the Transport Trolley to Put Food Inside the Cooking Compartment and Take It Out 76
- Putting Away and Removing the Core Temperature Probe 81
- Using a USB Stick 82

Rules

Putting plates inside the combi steamer is only allowed when rethermalizing food.

Prerequisites

- You must be familiar with how to use the software to such an extent that you will be able to access the stored cooking profiles you will need for your food or enter a new cooking profile and start it (see operating instructions).
- The combi steamer and the accessories being used must have been cleaned properly.
- There must not be any foreign objects inside the cooking compartment.
- The cooking compartment drain must be clear. It must not be clogged or blocked by any residues. The strainer on the oven drain must be in place.
- The appliance door’s inner glass door must be properly locked in place.
- The suction panel is properly locked in place.
- The USB cover must be covering the USB port.
- If the appliance is on top of an open stand: There must not be any hot, steaming food inside the stand.



When using racks:

- The racks have been installed and are locked in place.
- You must have the food that will be put inside the combi steamer ready to go.









When using a mobile shelf rack:

- The racks must have been removed.
- The roll-in frame for the mobile shelf rack must be installed inside the cooking compartment.
- The core temperature probe must be in its holder.
- You must have the food that will be put inside the combi steamer ready to go in the mobile shelf rack or in the plate rack on the transport trolley.

Cooking Procedures

- | | | |
|----|---|--|
| 1. |  | Open a cooking profile from the cookbook or enter a new cooking profile. |
| 2. |  | Follow the software’s prompts. |

4 How to Cook with Your Combi Steamer

3.		Open the appliance door.
4.		Place the food inside the combi steamer.
5.		Close the appliance door.
6.		Start the cooking sequence.
7.		Wait until the cooking sequence is done.
8.		Once the cooking sequence is done, the appliance will make a sound to let you know. Follow the software's prompts.
9.		Open the appliance door.
10.		Take out the food.
11.		Close the appliance door.

4.2.4 Smoking Procedures

⚠ For your safety when working with/on the combi steamer

Before starting work, read and understand the rules, risks, and hazards specified in “*Safely Using the Appliance* on page 54” and follow all the corresponding instructions without exception.

Opening the appliance door

⚠WARNING

Risk of burns caused by the ignition of smoking chips, pellets, bisquettes, etc. and smoke; risk of smoke inhalation

Air flowing into the cooking compartment may cause smoking bisquettes and/or smoke to combust explosively. Inhaling smoke may result in trouble breathing.

- ▷ Under no circumstance open the appliance door during smoking.

Procedures that you must be familiar with



You will need to be familiar with the following steps:









- Safely Opening and Closing the Appliance Door 68
- Filling the Smoker Box, Placing It Inside the Appliance, and Removing It from the Appliance 86
- Placing Food Inside and Taking It Out 69
- Using a USB Stick 82

Prerequisites



- You must be familiar with how to use the software well enough so that you will be able to access the stored cooking profiles you will need for your food or enter a new cooking profile for smoking and start it. (see operating instructions).
- The combi steamer and the accessories being used must have been cleaned properly.
- The cooking compartment drain must be clear. It must not be clogged or blocked by any residues.
- The appliance door’s inner glass door must be properly locked in place.
- The smoker box must be properly filled and ready to go.
- The suction panel is properly locked in place.
- The racks have been installed and are locked in place.
- The USB cover must be covering the USB port.
- If the appliance is on top of an open stand: There must not be any hot, steaming food inside the stand.
- You must have the food that will be put inside the combi steamer ready to go.













How to smoke food when your cooking profile only includes smoking

- | | | |
|----|---|--|
| 1. |  | Open a cooking profile from the cookbook or enter a new cooking profile. |
| 2. |  | Follow the software’s prompts. |
| 3. |  | Open the appliance door. |

4.		Place the smoker box inside.
5.		Place the food inside the combi steamer. The bottommost rack level must remain free due to the smoker box – do not put anything in it!
6.		Close the appliance door.
7.		Start the smoking sequence.
8.		Wait until the smoking sequence is done.
9.	Once the smoking sequence is done, the appliance will make a sound to let you know. Follow the software's prompts.	
10.		Open the appliance door.
11.		Remove the smoked food.
12.		Remove the smoker box.
13.		Close the appliance door.

How to smoke food when your cooking profile includes cooking and smoking

1.		Open a cooking profile from the cookbook or enter a new cooking profile.
2.		Follow the software's prompts.
3.		Open the appliance door.

4.		<p>Place the food inside the combi steamer. The bottommost rack level must remain free due to the smoker box that will go in later on – do not put anything in it!</p>
5.		<p>Close the appliance door.</p>
6.		<p>Start the cooking sequence.</p>
7.		<p>Wait until the cooking sequence is done.</p>
8.		<p>Once the cooking steps before smoking are done, the appliance will make a sound to let you know. Follow the software's prompts:</p> <ul style="list-style-type: none"> ▪ The cooking compartment will be cooled down with a "Cool down" sequence. ▪ You will then be prompted to put the smoker box inside.
9.		<p>Open the appliance door.</p>
10.		<p>Place the smoker box inside.</p>
11.		<p>Close the appliance door.</p>
12.		<p>Start the smoking sequence.</p>
13.		<p>Wait until the smoking sequence is done.</p>
14.		<p>Once the smoking sequence is done, the appliance will make a sound to let you know. Follow the software's prompts.</p>
15.		<p>Open the appliance door.</p>
16.		<p>Remove the smoked food.</p>

17.



Remove the smoker box.

18.



Close the appliance door.

4.3 Specific Cooking Instructions

Contents

This section covers the following subjects:

	Page
Safely Using the Appliance	66
Safely Opening and Closing the Appliance Door	68
Placing Food Inside and Taking It Out	69
Putting Food Inside the Mobile Shelf Rack	71
Taking Food Out from the Mobile Shelf Rack	73
Placing the Roll-In Frame for the Mobile Shelf Rack Inside the Cooking Compartment	74
Using the Transport Trolley to Put Food Inside the Cooking Compartment and Take It Out	76
Putting Away and Removing the Core Temperature Probe	81
Using a USB Stick	82
Removing and Installing the Racks	83
Filling the Smoker Box, Placing It Inside the Appliance, and Removing It from the Appliance	86



4.3.1 Safely Using the Appliance

For your and your employees' safety

Every person (user) must read and understand the contents in the “*For Your Safety* on page 21” section before they work with or on the combi steamer for the first time. In addition, every user must follow the instructions and warnings in said section at all times.

As the combi steamer's owner, or as the owner's employee responsible for the staff who will be using the combi steamer, set the necessary rules and brief all new employees.

Every user must read and understand the safe work rules specified in this section before starting any work and follow them without exception.

Every user must read and understand the risks and hazards described in this section and in the following instructions before starting any work and follow the corresponding safety instructions without exception.

Personal protective equipment for all users

As a user, you must wear the personal protective equipment specified for your work in the “*Personal Protective Equipment* on page 46” section of “*For Your Safety*.”

What to do if you smell gas

If you smell gas, follow the steps below without exception:

- Immediately shut off the gas.
- Thoroughly ventilate the room.
- Do not operate any electrical devices or equipment. Make sure not to cause any sparks.
- Evacuate the building.
- Call the gas company and, if necessary, the fire department on a telephone found outside the hazardous area.

Handling heavy loads

Please keep in mind that lifting heavy bakeware and moving heavy transport trolleys can result in fatigue, discomfort, and musculoskeletal system issues.

Hot surfaces

⚠ WARNING

Risk of burns posed by high temperatures inside the cooking compartment and on the inside of the appliance door

Touching any interior cooking compartment parts, the inside of the appliance door, or any parts that are or were found inside the cooking compartment during cooking may result in burns.

- ▷ Wear appropriate personal protective equipment.

Hot steam

⚠ CAUTION

Risk of scalding posed by hot steam

Hot steam coming out from the appliance may scald your face, hands, feet, and/or legs.

- ▷ When opening the appliance door, make sure to always use the cracked-open position as per the instructions on how to safely open the appliance door. Do not, under any circumstance, stick your head inside the cooking compartment.
- ▷ When cooling down the cooking compartment with the “Cool down” function, step away from the appliance, as hot steam will come out through the open appliance door.

Wet kitchen floors

⚠ CAUTION

Slip hazard posed by drained condensate

Condensate dripping onto the floor when the appliance door is opened may cause the operator to slip in front of the appliance.

- ▷ Always keep the floor around the appliance dry

Leaking gas

⚠ DANGER

Explosion hazard posed by gas leaks

Gas leaks may result in an explosion in the presence of an ignition source.

- ▷ Do not move the appliance during operation.
- ▷ If using an appliance that is placed on a base with casters and is connected using a flexible connecting hose, check to make sure that the retaining element designed to limit how much the base can move with the appliance is attached so that the appliance will be mechanically secured.

Lack of oxygen

⚠ DANGER

Suffocation hazard due to lack of oxygen

Inadequate ventilation at the installation location may result in suffocation when the appliance is run.

- ▷ Do not block or otherwise obstruct the area below the appliance.
- ▷ Operate the appliance in windless environments only.
- ▷ Make sure that the installed ventilation equipment works properly and follow all the ventilation rules specified by the installation technician.
- ▷ Arrange for the appliance to be serviced once a year.

4.3.2 Safely Opening and Closing the Appliance Door

⚠ For your safety when using the appliance

Before starting work, read and understand the rules, risks, and hazards specified in “*Safely Using the Appliance* on page 66” and follow all the corresponding instructions without exception.

Prerequisites

When placed on top of a work table, the appliance must be secured in such a way that it will not slide out of place.

Safely opening the appliance door

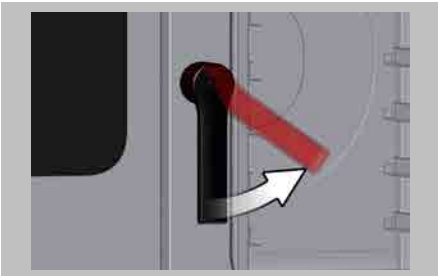
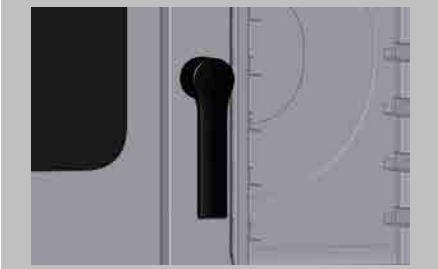
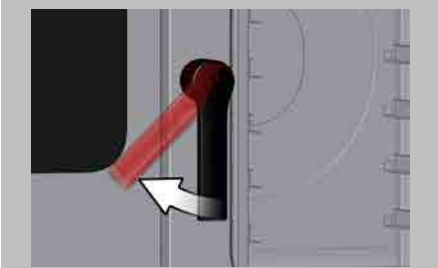
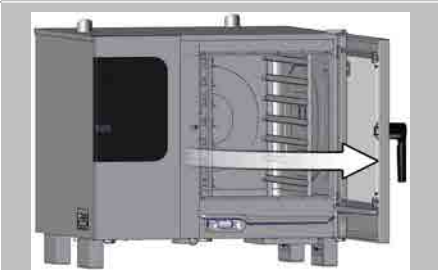
-  1. Turn the door handle to the right.
Result:
The appliance door will open into its cracked-open position and the door handle will swing back to its resting position.
-  2. Wait a moment to make sure that all steam is allowed to escape.
-  3. Turn the door handle to the left and open the appliance door slowly.
-  4. On appliances with a right-hinged door:
Fully open the appliance door.
On appliances with a disappearing door:
Slide the appliance door backwards along the combi steamer's side.

Safely closing the appliance door

On table-top models with a stop on the right-hand side:

Close the appliance door with a little momentum.

On table-top models with a disappearing door:

Pull the appliance door all the way to the front along the combi steamer's side and close it with a little momentum.

4.3.3 Placing Food Inside and Taking It Out

⚠ For your safety when using the appliance

Before starting work, read and understand the rules, risks, and hazards specified in “*Safely Using the Appliance* on page 66” and follow all the corresponding instructions without exception.

Hot liquids

⚠ WARNING

Risk of scalding posed by hot liquids

Spilling liquid food can result in scalding to the face and hands.

- ▷ When moving the food into the cooking compartment, make sure that the racks are correctly locked in place.
- ▷ Take the maximum loading weight into account.
- ▷ Use bakeware with matching standard dimensions only (steam table pans, sheet pans, etc.)
- ▷ Slide in the food containers correctly according to the rules on Page 49 for size X.10 appliances or the rules on Page 49 for size X.20 appliances, as applicable.
- ▷ Bakeware containing liquids or food that will become liquefied during cooking must be placed only in rack levels that will allow all operators to easily look in. When taking out bakeware containing liquids or food that will become liquefied during cooking, make sure it is in a perfectly horizontal position.
- ▷ Wear the required personal protective equipment.

Procedures that you must be familiar with

You will need to be familiar with the following steps:

- Safely Opening and Closing the Appliance Door

68

Putting food into the combi steamer (racks)

1.  Open the appliance door.

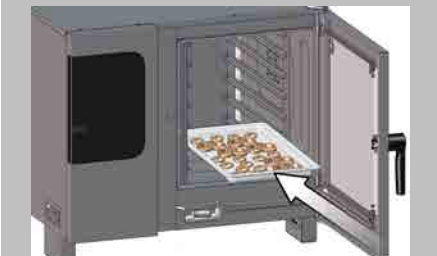
2.  Move the food into the rack levels you want.
- Start from the bottom.
 - Always slide bakeware, sheet pans, and shelf grills in all the way to the stop.
- Check to make sure that the bakeware, sheet pans, and shelf grills have been slid in correctly as indicated in “*Placing Food Containers in Size X.10 Appliances*” on page 49 or “*Placing Food Containers in Size X.20 Appliances*” on page 50 (as applicable).

Taking food out (racks)

1.

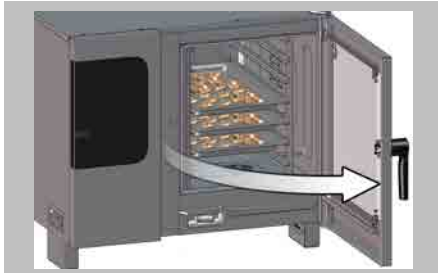

Open the appliance door.

2.



Take out the food, making sure the container is in a horizontal position.

WARNING! Risk of scalding posed by hot liquids

- When taking out sheet pans from baking racks, do not pull them forward too much, as they may topple over and out of the rack.

4.3.4 Putting Food Inside the Mobile Shelf Rack

⚠ For your safety when using the appliance

Before starting work, read and understand the rules, risks, and hazards specified in “*Safely Using the Appliance* on page 66” and follow all the corresponding instructions without exception.

Hot liquids

⚠WARNING

Risk of scalding posed by hot liquids

Spilling liquid food can result in scalding to the face and hands.

- ▷ Make sure that the mobile shelf rack’s latch is engaged when putting food inside or taking it out.
- ▷ Take the maximum loading weight into account.
- ▷ Use bakeware with matching standard dimensions only (steam table pans, sheet pans, etc.)
- ▷ Slide in the food containers correctly according to the rules on Page 49 for size X.10 appliances or the rules on Page 49 for size X.20 appliances, as applicable.
- ▷ Bakeware containing liquids or food that will become liquefied during cooking must be placed only in rack levels that will allow all operators to easily look in. When taking out bakeware containing liquids or food that will become liquefied during cooking, make sure it is in a perfectly horizontal position.
- ▷ Wear the required personal protective equipment.

Prerequisites that must be met before placing food in the mobile shelf rack

- The mobile shelf rack must have been properly cleaned.
- The transport trolley must be ready.
- All the transport trolley’s parking brakes must be locked.

Putting Food Inside the Mobile Shelf Rack

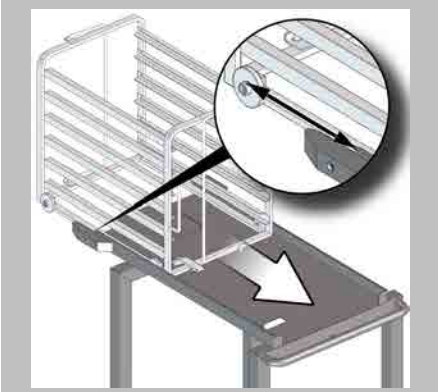
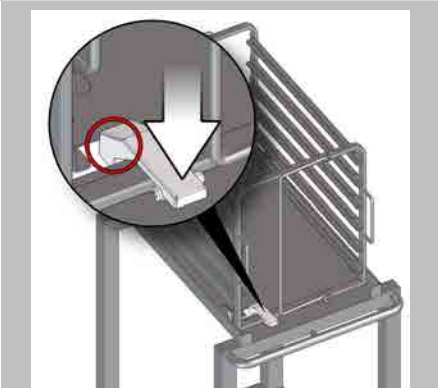
1.  Slide the mobile shelf rack onto the transport trolley from behind. Make sure that the wheel axles go under the transport trolley’s hem.
2.  Engage the latch.

3.

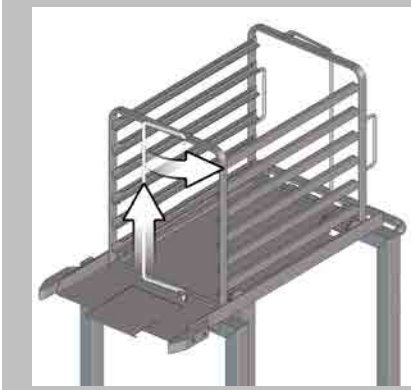

Lift the tray guard bar at the back of the mobile shelf rack and swing it to the right side.

4.

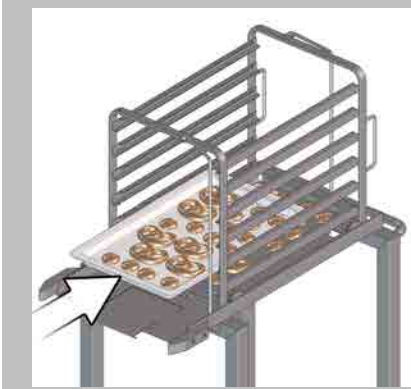

Place the food inside the mobile shelf rack.

- Start from the bottom.
- Make sure to always slide bakeware, sheet pans, and shelf grills in all the way to the other tray guard bar.

Check to make sure that the bakeware, sheet pans, and shelf grills have been slid in correctly as indicated in *"Placing Food Containers in Size X.10 Appliances"* on page 49 or *"Placing Food Containers in Size X.20 Appliances"* on page 50 (as applicable).

WARNING! Risk of scalding posed by hot liquids

- Make sure not to load the mobile shelf rack in such a way that it will be top-heavy, as the transport trolley may otherwise topple over when moving.

5.

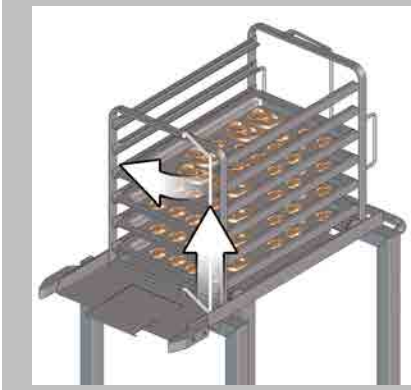

Lock the tray guard bar you previously opened back in place.

4.3.5 Taking Food Out from the Mobile Shelf Rack

⚠ For your safety when using the appliance

Before starting work, read and understand the rules, risks, and hazards specified in “*Safely Using the Appliance* on page 66” and follow all the corresponding instructions without exception.

Hot liquids

⚠ WARNING

Risk of scalding posed by hot liquids

Spilling liquid food can result in scalding to the face and hands.

- ▷ Make sure that the mobile shelf rack’s latch is engaged when putting food inside or taking it out.
- ▷ Take the maximum loading weight into account.
- ▷ Use bakeware with matching standard dimensions only (steam table pans, sheet pans, etc.)
- ▷ Slide in the food containers correctly according to the rules on Page 49 for size X.10 appliances or the rules on Page 49 for size X.20 appliances, as applicable.
- ▷ Bakeware containing liquids or food that will become liquefied during cooking must be placed only in rack levels that will allow all operators to easily look in. When taking out bakeware containing liquids or food that will become liquefied during cooking, make sure it is in a perfectly horizontal position.
- ▷ Wear the required personal protective equipment.

Prerequisites that must be met before taking food out

- The mobile shelf rack must be safely resting on a suitable surface.
- If the mobile shelf rack is still on top of the transport trolley:
 - The mobile shelf rack’s latch must be engaging the transport trolley.
 - All the transport trolley’s parking brakes must be locked.

Taking food out from the mobile shelf rack

1.

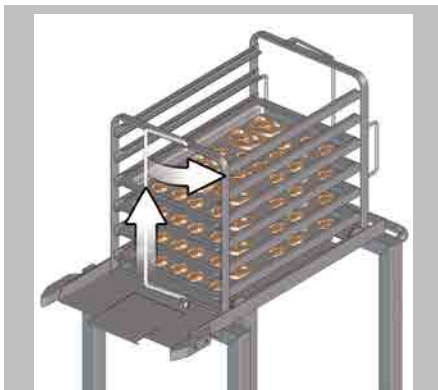

Lift the tray guard bar at the back of the mobile shelf rack and swing it to the right side.

2.

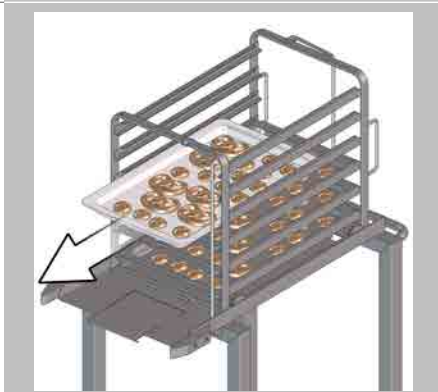

Take out the food, making sure the container is in a horizontal position.

4.3.6 Placing the Roll-In Frame for the Mobile Shelf Rack Inside the Cooking Compartment

For your safety when using the appliance

Before starting work, read and understand the rules, risks, and hazards specified in “*Safely Using the Appliance* on page 66” and follow all the corresponding instructions without exception.

Hot surfaces

WARNING

Risk of burns posed by high temperatures on the appliance’s interior and exterior parts.

Touching any interior cooking compartment parts, the inside of the appliance door, or any parts that are or were found inside the cooking compartment during cooking may result in burns.

- ▷ Before changing the equipment inside the cooking compartment, wait until the compartment has cooled down to a temperature lower than 140 °F or cool it down with the “Cool down” function.
- ▷ Wear the required personal protective equipment.

Procedures that you must be familiar with

You will need to be familiar with the following steps:

- Safely Opening and Closing the Appliance Door 68
- Removing and Installing the Racks 83

Required accessories

- Roll-in frame

Prerequisites

- The racks must have been removed.
- The appliance door must be open.

Placing the Roll-In Frame for the Mobile Shelf Rack Inside the Cooking Compartment

1.

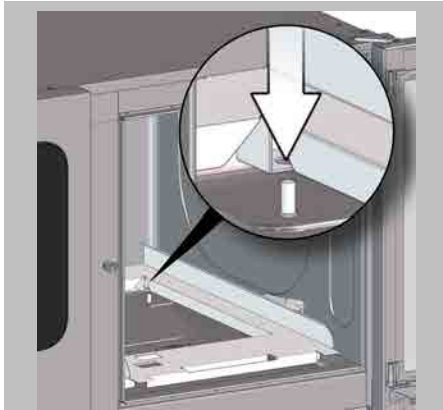

Secure the roll-in frame inside the cooking compartment by guiding the holes on the roll-in frame's foot angle brackets onto the pins on the bottom of the cooking compartment.

2.

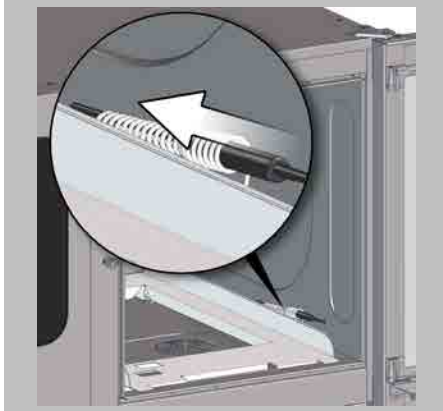

Slide the core temperature probe into the spiral holder on the right side of the roll-in frame.

4.3.7 Using the Transport Trolley to Put Food Inside the Cooking Compartment and Take It Out

For your safety when using the appliance

Before starting work, read and understand the rules, risks, and hazards specified in “*Safely Using the Appliance* on page 66” and follow all the corresponding instructions without exception.

Procedures that you must be familiar with

You will need to be familiar with the following steps:

- Putting Food Inside the Mobile Shelf Rack 71
- Placing the Roll-In Frame for the Mobile Shelf Rack Inside the Cooking Compartment 74

Required accessories

- Transport trolley
- Mobile shelf rack or plate rack

Prerequisites

- The roll-in frame for the mobile shelf rack must be installed inside the cooking compartment.
- The combi steamer must have been set up at the right height for the transport trolley. The roll-in frame inside the cooking compartment and the mobile shelf rack’s support surface on the transport trolley must be at the same height if the transport trolley is secured to the combi steamer.
- The appliance door must be open.
- The food must already be ready to go inside the mobile shelf rack on the transport trolley:
 - The mobile shelf rack’s latch must be engaged.
 - The transport trolley’s tray guard bar must be locked in place.

Using the transport trolley to put food inside the cooking compartment

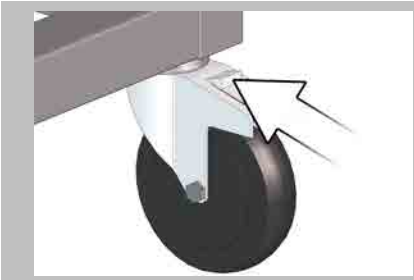
1. 

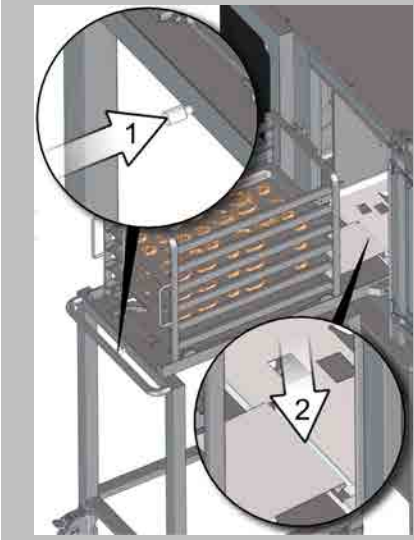
Release the transport trolley's parking brakes and move the trolley in front of the combi steamer.
2. 

Secure the transport trolley on the combi steamer.

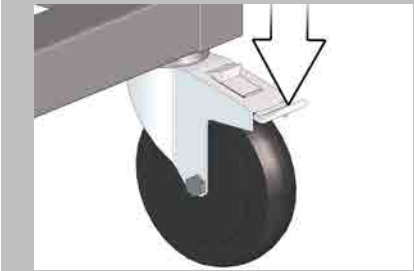
 - Press the button underneath the transport trolley's handlebar so that the engaging mechanism on the back of the trolley will be raised.
 - Then release the button so that the engaging mechanism will be lowered and engage the cooking compartment opening.
3. 

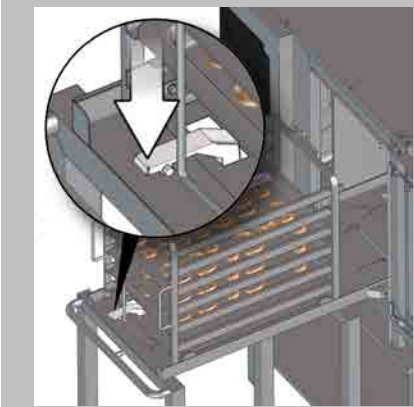
Lock all the transport trolley casters' wheels.
4. 

Release the mobile shelf rack's latch.

5.

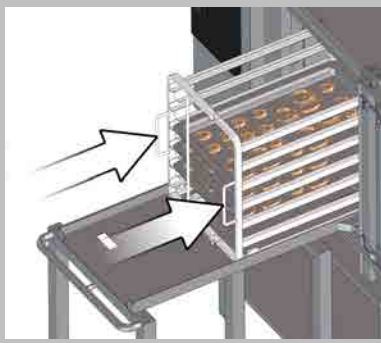

Slide the mobile shelf rack away from the transport trolley and into the cooking compartment.

6.

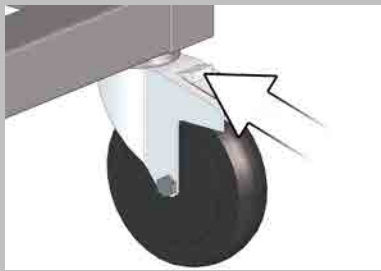

Release the transport trolley's parking brakes.

7.

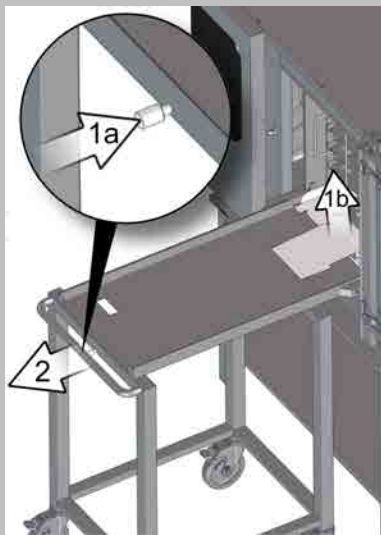

Release the transport trolley's engaging mechanism from the cooking compartment opening and move the trolley away.

8.

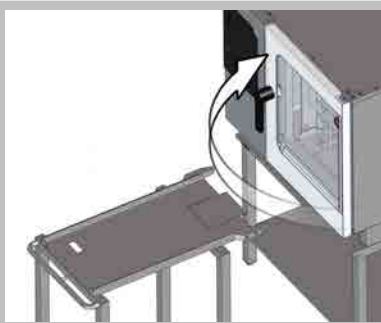

Close the appliance door.

Using the transport trolley to take food out

1.

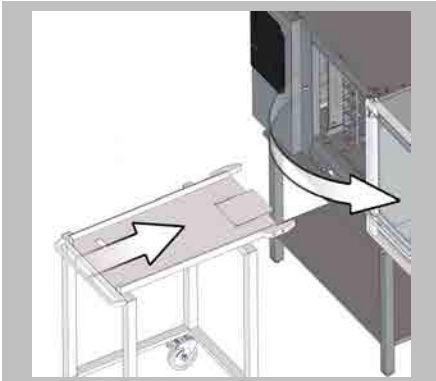

Open the appliance door and move the trolley in front of the combi steamer.

2.

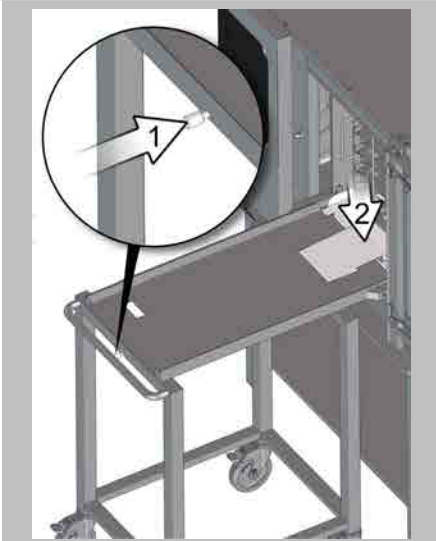

Secure the transport trolley on the combi steamer.

- Press the button underneath the transport trolley's handlebar so that the engaging mechanism on the back of the trolley will be raised.
- Then release the button so that the engaging mechanism will be lowered and engage the cooking compartment opening.

3.

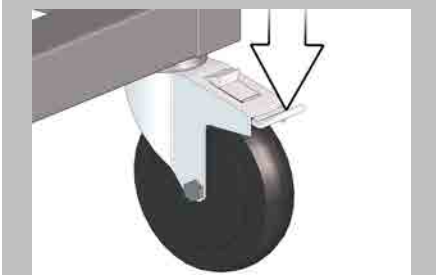

Lock all the transport trolley casters' wheels.

4.

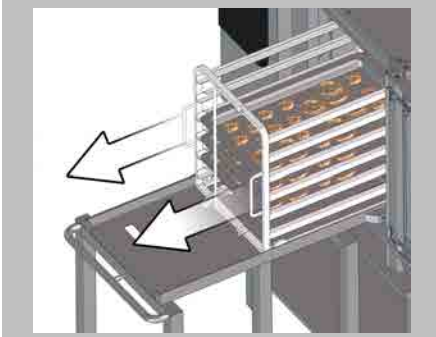

Pull the mobile shelf rack out from the cooking compartment and onto the transport trolley.

WARNING! Risk of burns posed by high temperatures inside the cooking compartment, on the inside of the appliance door, and on the mobile shelf rack

- Wear the required personal protective equipment.
- Use the handles to pull the mobile shelf rack out of the cooking compartment.

5.

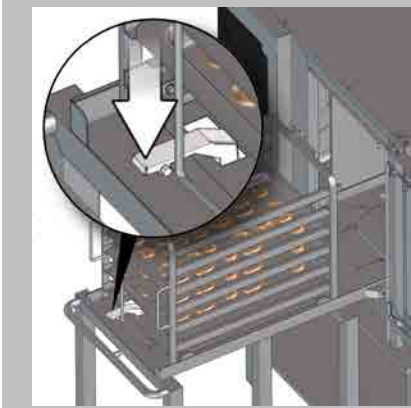

Engage the latch.

6.

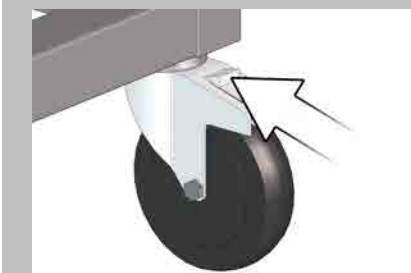

Release the transport trolley's parking brakes.

7.

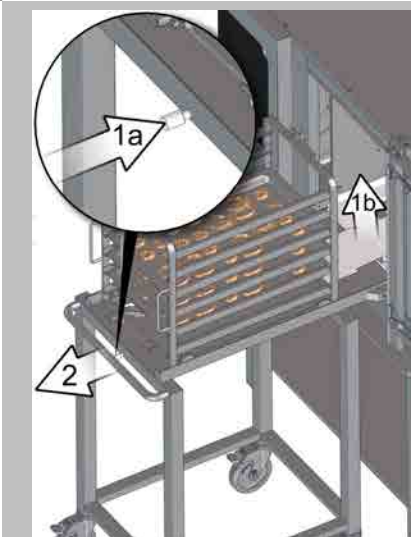

Release the transport trolley's engaging mechanism from the cooking compartment opening and move the trolley away.

WARNING! Risk of scalding posed by hot liquids

- Cover any bakeware containing hot liquids while moving it.
- Make sure that the transport trolley does not topple over with the mobile shelf rack. The transport trolley is at risk of toppling over when being moved across an inclined surface or when it runs into an obstacle.

8.

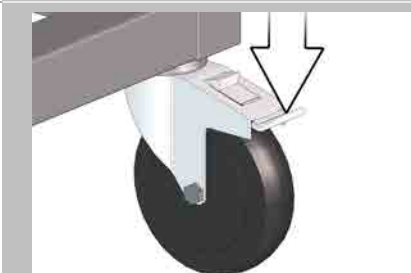

Lock all the transport trolley casters' wheels.

9.

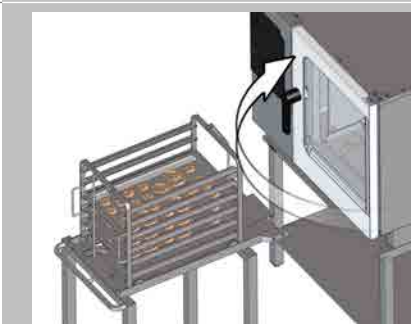

Close the appliance door.

4.3.8 Putting Away and Removing the Core Temperature Probe

⚠ For your safety when using the appliance

Before starting work, read and understand the rules, risks, and hazards specified in “*Safely Using the Appliance* on page 66” and follow all the corresponding instructions without exception.

Procedures that you must be familiar with

You will need to be familiar with the following steps:

- Safely Opening and Closing the Appliance Door

68

Purpose

If you will not be needing the core temperature probe for the cooking process you will be using, make sure to put it away. Not doing so may result in the probe being damaged.

Putting away the core temperature probe for table-top models

1.

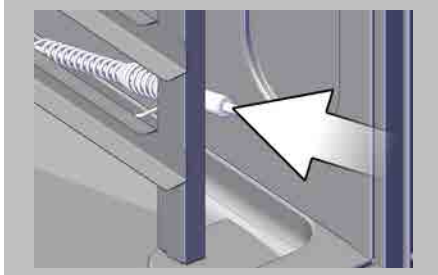

Slide the core temperature probe into the spiral holder on the right-hand side rack.

NOTICE! Pay attention to the cable!
The cable must not get pinched in between the appliance door and the hygienic plug-in gasket when the door is closed.

Removing the core temperature probe for table-top models

Pull the core temperature probe out from the holder on the right-hand side rack.

4.3.9 Using a USB Stick

⚠ For your safety when using the appliance

Before starting work, read and understand the rules, risks, and hazards specified in “*Safely Using the Appliance* on page 66” and follow all the corresponding instructions without exception.

USB cover function

The USB cover protects the USB port so that no steam will be able to enter the control system electronics during cooking or cleaning.

Make sure that there is no USB stick plugged in and that the port is sealed off by the cover during cooking and cleaning.

Plugging in the USB stick

1.

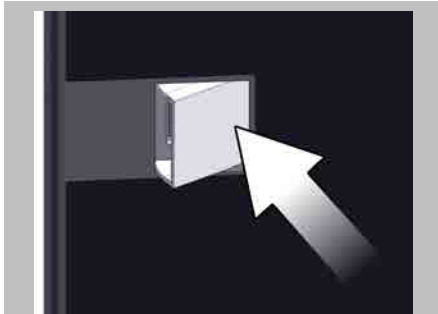

Open the USB port cover on the control panel.

2.

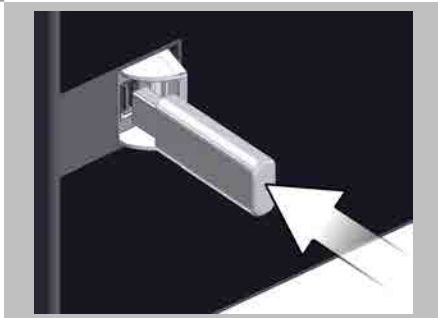

Plug in the USB stick.
If the USB stick is too big, use an adapter cable.

4.3.10 Removing and Installing the Racks

⚠ For your safety when using the appliance

Before starting work, read and understand the rules, risks, and hazards specified in “*Safely Using the Appliance* on page 66” and follow all the corresponding instructions without exception.

Hot surfaces

⚠ WARNING

Risk of burns posed by high temperatures on the appliance’s interior and exterior parts.

Touching any interior cooking compartment parts, the inside of the appliance door, or any parts that are or were found inside the cooking compartment during cooking may result in burns.

- ▷ Before changing the equipment inside the cooking compartment, wait until the compartment has cooled down to a temperature lower than 140 °F or cool it down with the “Cool down” function.
- ▷ Wear the required personal protective equipment.

Procedures that you must be familiar with

You will need to be familiar with the following steps:

- Safely Opening and Closing the Appliance Door 68
- Putting Away and Removing the Core Temperature Probe 81

Prerequisites

- All food containers and other accessories used for cooking must have been removed from the cooking compartment.

Removing the racks

1.

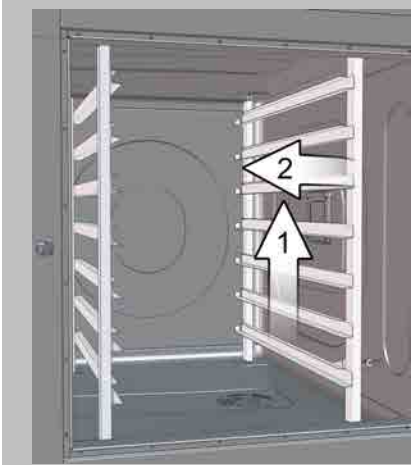

Lift (1) the rack and swing it (2) towards the inside of the cooking compartment.

2.

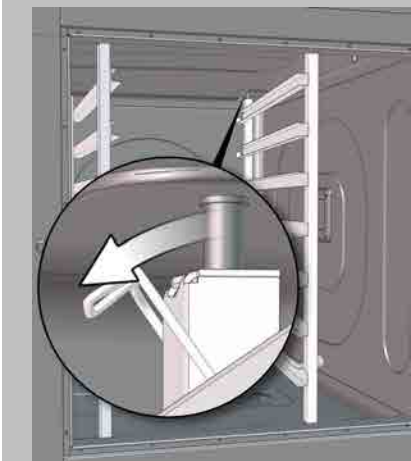

Release the retainer on the rear top corner that is holding the rack in place.

3.

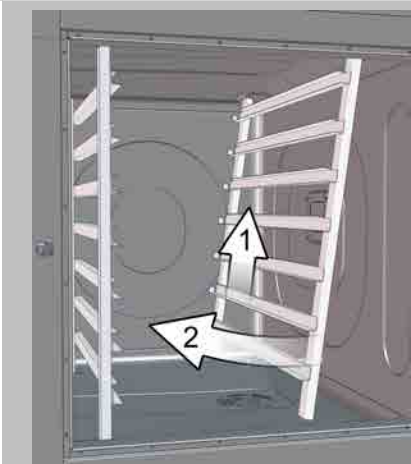

Push(1) the rack upwards and remove (2) it.

Installing the racks

1.

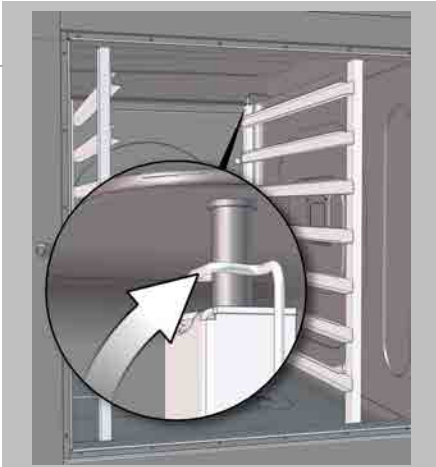

Follow the same steps used to remove the racks, but in opposite order.

2.

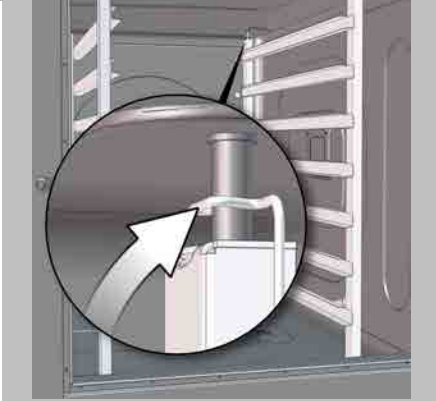

Check to make sure that the retainers on the rear top corners are engaging the racks properly so that the latter are correctly secured.

3.



- To check that both racks are properly installed, slide a sheet pan in.
- Check to make sure that the sheet pan is correctly in place in or on the rails as indicated in *“Placing Food Containers in Size X.10 Appliances”* on page 49 or *“Placing Food Containers in Size X.20 Appliances”* on page 50 (as applicable).

4.3.11 Filling the Smoker Box, Placing It Inside the Appliance, and Removing It from the Appliance

For your safety when using the appliance

Before starting work, read and understand the rules, risks, and hazards specified in “*Safely Using the Appliance* on page 66” and follow all the corresponding instructions without exception.

Air flowing in

WARNING

Risk of burns and fire hazard posed by flying sparks

Flying sparks may be produced if air flows into hot smoking bisquettes

- ▷ Do not remove the smoker box’s cover until the box has cooled down completely in a fireproof location that is not exposed to wind. Always keep the cover on the smoker box during smoking.
- ▷ Do not dispose of ashes or used bisquettes until they are cold.

Procedures that you must be familiar with

You will need to be familiar with the following steps:

- Safely Opening and Closing the Appliance Door

68

Smoking bisquettes

Only use smoking bisquettes that are made of hardwood chips and are intended for this purpose. The manufacturer recommends using BRADLEY SMOKING BISQUETTES, which can be bought on the Internet (<http://www.bradleysmoker.com>) or at appropriate specialty retailers.

Do not use smoking materials such as loose sawdust, loose wood shavings, loose wood chips, or small pieces of wood.

Prerequisites

- The cooking compartment must have cooled down to the ambient temperature since the last time it was used.
or
The software must have prompted you to put the smoker box inside as part of the cooking profile that is running.
In this case, the software will automatically run a “Cool down” sequence to cool down the cooking compartment before prompting you to put the smoker box inside.
- The smoker heater must be in place inside the cooking compartment.
- The racks have been installed and are locked in place.
- The smoker box’s bisquette support lid, cover, and actual box must have been properly cleaned and dried.

Filling the smoker box

1.

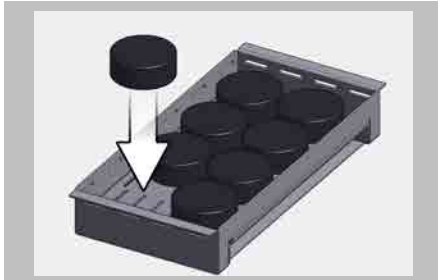

To fill the smoker box, place a maximum of eight bisquettes on the bisquette support lid inside it.

2.

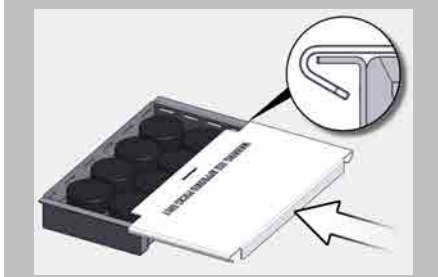

Starting from the back of the box, slide the cover onto the smoker box as far as it will go. Make sure that the folds on the sides of the cover slide along the wings on the sides of the box (as shown in the diagram to the left).

3.

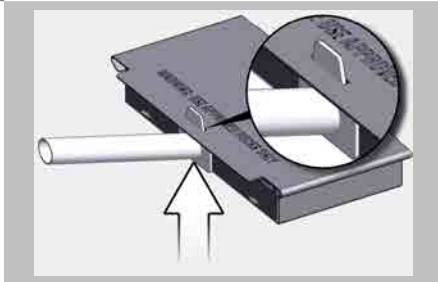

Insert the handle into the front of the smoker box.

Placing the smoker box inside the cooking compartment

1.

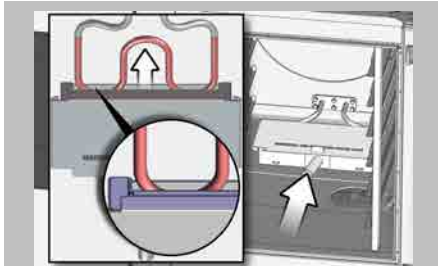

Grab the smoker box containing the bisquettes from the handle and slide it all the way onto the smoker heater inside the cooking compartment. Make sure that the heating element goes into the smoker box opening meant for the smoker heater.

2.

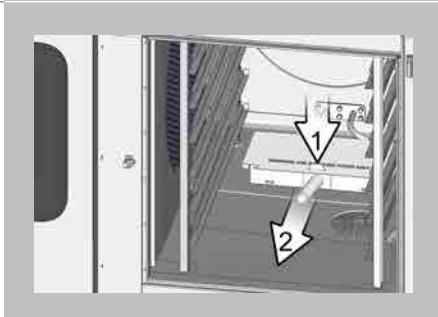



Remove the smoker box's handle.

WARNING! Risk of burns posed by high temperatures inside the cooking compartment, on the inside of the appliance door, and on the smoker box

- Wear the required personal protective equipment.
- Once you have placed the smoker box inside the cooking compartment, take the box's handle out of the compartment so that the handle will be cold when you take out the box later on.

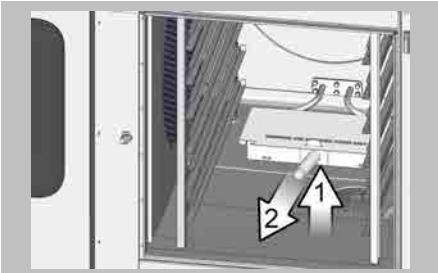
Removing the smoker box from the cooking compartment

1. 

Insert the handle into the smoker box and pull the box out from the smoker heater.
2. 

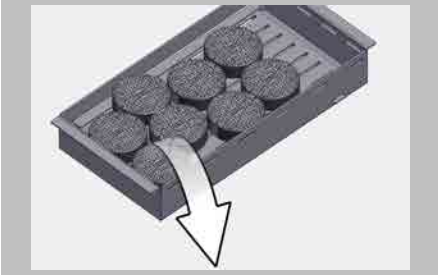
Let the smoker box fully cool down outside of the cooking compartment in a fireproof location that is not exposed to wind.
3. 

Empty the smoker box of ashes and the remains of the bisquettes you used and thoroughly clean all of the smoker box's parts.

5 How to Clean the Combi Steamer

Purpose of this section

This section provides an overview of the cleaning methods, cleaning agents (and how to handle them), and cleaning schedule for the combi steamer. It goes over how to handle and use the combi steamer when cleaning it and what kind of steps you need to follow.

“General Cleaning Instructions” provides a step-by-step guide through the various cleaning sequence workflows. This section does not explicitly explain how to use the software or the appliance components.

To learn more about how to use the software and its workflows, please consult the combi steamer’s operating instructions.

“Specific Cleaning Instructions” goes over specific actions that must be carried out when using the combi steamer and the corresponding accessories.

Contents

This section covers the following subjects:

	Page
Combi Steamer Cleaning Basics	90
General Cleaning Instructions	97
Specific Cleaning Instructions	114

5.1 Combi Steamer Cleaning Basics

Contents

This section covers the following subjects:

	Page
Cleaning Methods	91
Cleaning schedule	93
Cleaning agents	95
Supplying Cleaning Agents	96

5.1.1 Cleaning Methods

Cleaning Methods

Cleaning Methods	Description	When to use
Oven cleaning without cleaning agents	<ul style="list-style-type: none"> ▪ Is a fully automatic process in which the temperature and duration are controlled by the software ▪ The cooking compartment is rinsed with water only (without using any cleaning agents) 	<ul style="list-style-type: none"> ▪ For cleaning very light soiling or eliminating odors between individual cooking sequences ▪ After prolonged periods of nonuse (to remove dust, for example), provided the combi steamer has been thoroughly cleaned before this
Fully automatic oven cleaning with connected canisters (ConvoClean for easyDial or ConvoClean+ for easyTouch)	<ul style="list-style-type: none"> ▪ Is a fully automatic process in which the temperature, duration, use of cleaning agents, and rinsing are controlled by the software ▪ Cleaning agents are dosed by the software and automatically conveyed from the connected canisters into the cooking compartment ▪ With easyDial (ConvoClean): <ul style="list-style-type: none"> ▪ One of eight preconfigured cleaning profiles needs to be selected (CL1 to CL4 and CL1d to CL4d) ▪ With easyTouch (ConvoClean+): <ul style="list-style-type: none"> ▪ A cleaning level needs to be selected (1 to 4) ▪ A cleaning duration needs to be selected (eco, regular, express) ▪ The steam disinfection and cooking compartment drying functions can also be optionally selected 	<ul style="list-style-type: none"> ▪ Daily cleaning after finishing all cooking for the day ▪ Before placing the combi steamer into operation for the first time in order to get rid of all cooking compartment soiling and impurities accumulated during transit, setup, and installation ▪ After performing maintenance on the combi steamer in order to get rid of all cooking compartment soiling and impurities
Fully automatic oven cleaning with single-measure dispensing (ConvoClean for easyDial or ConvoClean+ for easyTouch)	<ul style="list-style-type: none"> ▪ Is a fully automatic process in which the temperature, duration, use of cleaning agents, and rinsing are controlled by the software ▪ The software will prompt the operator to apply cleaning agents from single-measure dispensing bottles into the cooking compartment ▪ With easyDial (ConvoClean): <ul style="list-style-type: none"> ▪ One of eight preconfigured cleaning profiles needs to be selected (CL1 to CL4 and CL1d to CL4d) ▪ With easyTouch (ConvoClean+): <ul style="list-style-type: none"> ▪ A cleaning level needs to be selected (1 to 4) ▪ A cleaning duration needs to be selected (eco, regular, express) ▪ The steam disinfection and cooking compartment drying functions can also be optionally selected 	<ul style="list-style-type: none"> ▪ Daily cleaning after finishing all cooking for the day ▪ Before placing the combi steamer into operation for the first time in order to get rid of all cooking compartment soiling and impurities accumulated during transit, setup, and installation ▪ After performing maintenance on the combi steamer in order to get rid of all cooking compartment soiling and impurities

Cleaning Methods	Description	When to use
Semi-automatic oven cleaning	<ul style="list-style-type: none"> ▪ Is a semi-automatic process in which the temperature and duration of individual stages are controlled by the software ▪ The cleaning agents are manually sprayed into the cooking compartment ▪ The cooking compartment is manually rinsed with the pullout spray head 	<ul style="list-style-type: none"> ▪ Daily cleaning after finishing all cooking for the day ▪ For further cleaning after fully automatic oven cleaning if the latter did not get rid of all soiling and impurities ▪ Before placing the combi steamer into operation for the first time in order to get rid of all cooking compartment soiling and impurities accumulated during transit, setup, and installation ▪ After performing maintenance on the combi steamer in order to get rid of all cooking compartment soiling and impurities
Oven cleaning using only rinse aid from a connected canister or single-measure dispensing (available only with the easyTouch ConvoCare cleaning profile)	<ul style="list-style-type: none"> ▪ Is a fully automatic process in which the temperature, duration, use of rinse aid, and rinsing are controlled by the software ▪ Rinse aid will either be automatically added to the cooking compartment from connected canisters in the right proportion or the software will prompt the operator to apply rinse aid from single-measure dispensing bottles into the cooking compartment 	<ul style="list-style-type: none"> ▪ For further cleaning after fully automatic or semi-automatic oven cleaning if the latter did not get rid of all soiling and impurities ▪ If there is a white film or dark discolorations inside the cooking compartment
Manual oven cleaning	<ul style="list-style-type: none"> ▪ Is an exclusively manual process without any software assistance <ul style="list-style-type: none"> ▪ The cooking compartment remains unheated ▪ The operator monitors the time during which the cleaning agents are allowed to work. ▪ The cleaning agents are manually sprayed into the cooking compartment ▪ The cooking compartment is manually rinsed with the pullout spray head 	<ul style="list-style-type: none"> ▪ For cleaning soiling or eliminating odors between individual cooking sequences after the cooking compartment has been cooled down ▪ For further cleaning after fully automatic or semi-automatic oven cleaning if the latter did not get rid of all soiling and impurities ▪ For cleaning specific spots or areas inside the cooking compartment, such as the oven drain ▪ If there is a white film or dark discolorations inside the cooking compartment

5.1.2 Cleaning schedule

Overview

The figure below shows a size 6.10 gas combi steamer used as an example representing all table-top models:

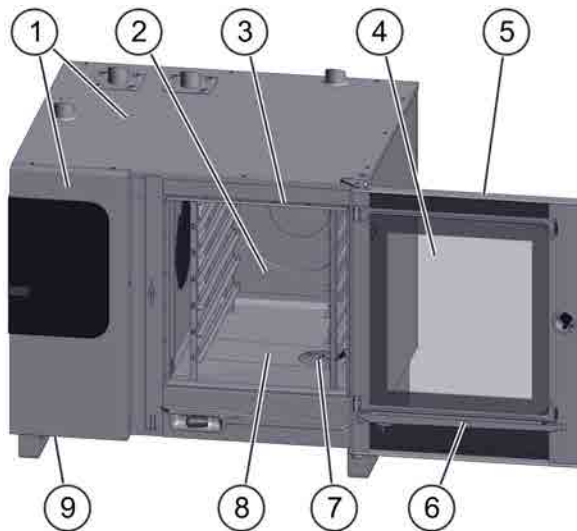

No.	Designation
1	Outside of appliance case
2	Cooking compartment
3	hygienic plug-in gasket
4	Double glass door
5	Appliance door
6	Door drip tray
7	Cooking compartment drain with strainer
8	Appliance drip tray
9	Lint screen

Daily cleaning

What needs to be cleaned?	Procedure	Cleaning agents
Cooking compartment	<ul style="list-style-type: none"> How to Semi-Automatically Clean the Cooking Compartment in Table-Top Models with Racks on page 104 How to Semi-Automatically Clean the Cooking Compartment in Table-Top Models with a Mobile Shelf Rack on page 106 	ConvoClean new or forte
	How to Fully Automatically Clean the Cooking Compartment Using Canisters on page 100	ConvoClean new or forte and ConvoCare
	How to Fully Automatically Clean the Cooking Compartment Using the Single-Measure Dispensing Mode on page 102	ConvoClean new S or forte S and ConvoCare S
The cooking compartment drain	<ul style="list-style-type: none"> Remove any residues Rinse out in order to prevent clogging Spray cleaning agent inside and rinse with water 	<ul style="list-style-type: none"> With the pullout spray head ConvoClean new or forte
Outside of appliance case	Clean by hand with a soft cloth	Common household stainless steel cleaner

What needs to be cleaned?	Procedure	Cleaning agents
Bakeware, sheet pans, shelf grills, and other accessories used for cooking	<ul style="list-style-type: none"> ▪ Clean by hand using a soft, non-abrasive sponge ▪ Rinse with water 	Common household dishwashing liquid
The cooking compartment needs to be checked daily to see if there is any white film or dark discolorations <ul style="list-style-type: none"> ▪ Clean only if necessary 	<ul style="list-style-type: none"> ▪ Manually: <ul style="list-style-type: none"> ▪ Spray cleaning agent on the film/discolorations while the combi steamer is not warm ▪ Let the cleaning agent work for 10 minutes ▪ Polish using a soft, non-abrasive sponge ▪ Rinse out <p>or</p> <ul style="list-style-type: none"> ▪ Use the ConvoCare cleaning profile (easyTouch only) 	ConvoCare

Weekly cleaning

What needs to be cleaned?	Procedure	Cleaning agents
The double glass door on the inside	<i>How to Clean the Double Glass Door</i> on page 110	Common household glass cleaner
The cooking compartment section behind the suction panel	<i>How to Clean the Cooking Compartment Section Behind the Suction Panel</i> on page 111	ConvoClean new or forte
Hygienic plug-in gasket around appliance door	<ul style="list-style-type: none"> ▪ Wipe all around by hand using a soft cloth and cleaning agent ▪ Thoroughly wipe clean with a soft cloth and water ▪ Dry with a soft cloth. ▪ Leave the appliance door ajar so that the hygienic plug-in gasket will dry off. 	Common household dishwashing liquid
Appliance door, door drip tray, and appliance drip tray	<ul style="list-style-type: none"> ▪ Clean by hand using a soft cloth and cleaning agent ▪ Thoroughly wipe clean with a soft cloth and water ▪ Dry with a soft cloth. 	ConvoClean new or forte
Lint screen/fan, bottom of cooking compartment on the left side	Clean by hand with a slightly damp cloth	Common household dishwashing liquid

Monthly cleaning

What needs to be cleaned?	Procedure	Cleaning agents
The hygienic plug-in gasket, thoroughly	<i>How to Clean the Hygienic Plug-In Gasket Thoroughly</i> on page 113	Common household dishwashing liquid
Stand (optional)	Clean by hand with a soft cloth	Common household stainless steel cleaner

5.1.3 Cleaning agents

Cleaning agents

Only use the cleaning agents specified here when cleaning the combi steamer and its accessories.

Product	Use for	Container
ConvoClean new For light soiling <ul style="list-style-type: none"> Not for cleaning bakeware, sheet pans, shelf grills, or other accessories 	Oven cleaning <ul style="list-style-type: none"> By hand Semi-automatic 	Spray bottle
	Fully automatic oven cleaning	Cleaning agent canisters connected to the cleaning system underneath the combi steamer
ConvoClean forte For normal to heavy soiling <ul style="list-style-type: none"> Not for cleaning bakeware, sheet pans, shelf grills, or other accessories 	Oven cleaning <ul style="list-style-type: none"> By hand Semi-automatic 	Spray bottle
	Fully automatic oven cleaning	Cleaning agent canisters connected to the cleaning system underneath the combi steamer
ConvoCare K (concentrate)	For preparing ready-to-use ConvoCare solution with a defined mix ratio	-
ConvoCare Rinse aid with defined mix ratio <ul style="list-style-type: none"> Not for cleaning bakeware, sheet pans, shelf grills, or other accessories 	<ul style="list-style-type: none"> Fully automatic oven cleaning Oven cleaning with rinse aid only (available only with the easyTouch ConvoCare cleaning profile) 	Cleaning agent canisters connected to the cleaning system underneath the combi steamer
	Manually cleaning the cooking compartment further	Spray bottle
ConvoClean new S For light soiling	Fully automatic oven cleaning	125-ml single-measure dispensing bottles
ConvoClean forte S For normal to heavy soiling	Fully automatic oven cleaning	125-ml single-measure dispensing bottles
ConvoCare S	<ul style="list-style-type: none"> Fully automatic oven cleaning Oven cleaning with rinse aid only (available only with the easyTouch ConvoCare cleaning profile) 	125-ml single-measure dispensing bottles
Common household stainless steel cleaner	Taking care of the combi steamer's outer surfaces	-
Common household glass cleaner	Cleaning the double glass door	-
Common household alkali-free, pH-neutral, odorless dishwashing liquid	<ul style="list-style-type: none"> Cleaning components and accessories as specified in the corresponding instructions Cleaning bakeware, sheet pans, shelf grills, and other accessories used for cooking 	-

5.1.4 Supplying Cleaning Agents

Supplying Cleaning Agents

Container	Handling / Use	Cleaning agents
Spray bottle	<ul style="list-style-type: none"> ▪ Never leave the spray bottle pressurized for an extended period of time if you are not using it. Slowly open the pump head so that the compressed air can escape. ▪ Rinse the spray bottle weekly. ▪ Rinse the nozzle, the nozzle extension, and the nozzle fitting after every use. ▪ Do not store spray bottles containing cleaning agents in the immediate vicinity of the combi steamer. Instead, store them in special storage rooms where they will not be close to nor come into contact with food. 	<ul style="list-style-type: none"> ▪ ConvoClean new ▪ ConvoClean forte ▪ ConvoCare
Canister	<ul style="list-style-type: none"> ▪ Connect the canisters containing the cleaning agents to the combi steamer's cleaning system. ▪ Before every fully automatic oven cleaning sequence, check whether the canisters still have enough cleaning agent in them. ▪ Do not store reserve canisters containing cleaning agents in the immediate vicinity of the combi steamer. Instead, store them in special storage rooms where they will not be close to nor come into contact with food. 	<ul style="list-style-type: none"> ▪ ConvoClean new ▪ ConvoClean forte ▪ ConvoCare
	<ul style="list-style-type: none"> ▪ Use Convo Care K (concentrate) only to prepare ready-to-use ConvoCare solution (with a defined mix ratio) in an empty canister. ▪ Do not store canisters containing Convo Care K in the immediate vicinity of the combi steamer. Instead, store them in special storage rooms where they will not be close to nor come into contact with food. 	<ul style="list-style-type: none"> ▪ Convo Care K (concentrate)
125-ml single-measure dispensing bottles	<ul style="list-style-type: none"> ▪ Do not remove the bottle from the shipping and storage box until right before using the cleaning agent. ▪ Do not open the bottle's cap until right before using the cleaning agent. ▪ Once the bottles are empty, rinse them out with water and close them again, then throw them into the recycling bin. ▪ Store the reserve bottles containing cleaning agents exclusively in the box in which they were shipped. Do not store the boxes in the immediate vicinity of the combi steamer. Instead, store them in special storage rooms where they will not be close to nor come into contact with food. 	<ul style="list-style-type: none"> ▪ ConvoClean new S ▪ ConvoClean forte S ▪ ConvoCare S

5.2 General Cleaning Instructions

Contents

This section covers the following subjects:

	Page
Working Safely When Cleaning	98
How to Fully Automatically Clean the Cooking Compartment Using Canisters	100
How to Fully Automatically Clean the Cooking Compartment Using the Single-Measure Dispensing Mode	102
How to Semi-Automatically Clean the Cooking Compartment in Table-Top Models with Racks	104
How to Semi-Automatically Clean the Cooking Compartment in Table-Top Models with a Mobile Shelf Rack	106
How to Clean the Cooking Compartment Without Using Cleaning Agents	109
How to Clean the Double Glass Door	110
How to Clean the Cooking Compartment Section Behind the Suction Panel	111
How to Clean the Hygienic Plug-In Gasket Thoroughly	113



5.2.1 Working Safely When Cleaning

For your and your employees' safety

Every person (user) must read and understand the contents in the “*For Your Safety* on page 21” section before they work with or on the combi steamer for the first time. In addition, every user must follow the instructions and warnings in said section at all times.

As the combi steamer's owner, or as the owner's employee responsible for the staff who will be using the combi steamer, set the necessary rules and brief all new employees.

Every user must read and understand the safe work rules specified in this section before starting any work and follow them without exception.

Every user must read and understand the risks and hazards described in this section and in the following instructions before starting any work and follow the corresponding safety instructions without exception.

Personal protective equipment for all users

As a user, you must wear the personal protective equipment specified for your work in the “*Personal Protective Equipment* on page 46” section of “*For Your Safety*.”

Rules for safely moving and parking bases with casters

In order to avoid hazards, follow the rules below when moving bases with casters with the appliances:

- If a fixed connection is being used, the drain pipe needs to be disconnected before moving the appliance.
- Pay attention to all utility and hose connections when moving the appliance. Make sure not to roll over any connection lines. Do not subject the connections to any tension whatsoever. In addition, make sure that they do not break off. The length of the utility and hose connections (electrical, gas, and water) will already account for the maximum distance that the base can move when the retaining element is attached. Nevertheless, it is necessary to always make sure that all connections are in the right position and routed properly both during and after moving the appliance
- De-energize the appliances before moving them.
- Let the appliances on the base cool down before moving them.
- There must not be any food left inside the appliances.
- The appliance doors must be closed.
- When moving the base with the appliances, make sure to wear appropriate protective clothing.
- The base with the appliances must always be moved by at least two people.
- The appliance must be level once it is pushed back into place.
- Lock the casters' wheels after pushing the appliance back into place.
- Make sure that the base will not topple over in any position.

Hosing down the appliance with water

⚠ DANGER

Risk of electric shock posed by live parts

Water on the appliance's exterior parts may produce a short circuit and result in electric shock upon touching the appliance.

- ▷ Do not spray water onto the appliance's exterior parts.
- ▷ Always keep the USB cover closed during cleaning.

Hot surfaces

▲WARNING

Risk of burns posed by high temperatures on the appliance's interior and exterior parts.

Touching any interior cooking compartment parts, the inside of the appliance door, or any parts that are or were found inside the cooking compartment during cooking may result in burns. Touching the exhaust vent and exhaust outlet may also result in burns.

- ▷ Before performing any cleaning work, wait until the cooking compartment has cooled down to a temperature lower than 140 °F or cool it down with the "Cool down" function.
- ▷ Wear the required personal protective equipment.

Spraying water into the cooking compartment while the latter is hot

▲WARNING

Risk of scalding posed by hot steam

If you spray water into cooking compartment while the latter is hot (e.g., with a spray head), the steam produced inside the cooking compartment may result in scalding.

- ▷ Before performing any cleaning work, wait until the cooking compartment has cooled down to a temperature lower than 140 °F or cool it down with the "Cool down" function.

Contact with cleaning agents

▲WARNING

Chemical burn hazard and skin, eye, and respiratory tract irritation hazard

The ConvoClean new (S) cleaning agent and the ConvoCare (S) rinse aid will cause skin, eye, and respiratory tract irritation upon direct contact. The ConvoClean forte (S) cleaning agent will result in chemical burns to the skin, eyes, and respiratory tract upon direct contact.

- ▷ Do not inhale the cleaning agents' and rinse aid's vapors or mist.
- ▷ Do not let the cleaning agents or rinse aid come into contact with your eyes, skin, or mucous membranes.
- ▷ Do not spray cleaning agents or rinse aid into a cooking compartment that is at a temperature higher than 140 °F, as doing so will cause more caustic and/or irritating cleaning-fluid vapors to be produced.
- ▷ If the canisters are connected, do not open the appliance door during the fully automatic oven cleaning process.
- ▷ If using single-measure dispensing, do not open the appliance door during the fully automatic oven cleaning process UNTIL asked to do so by the software.
- ▷ Wear the required personal protective equipment.

Leaking gas

▲DANGER

Explosion hazard posed by gas leaks

Gas leaks may result in an explosion in the presence of an ignition source.

- ▷ In the case of appliances on a base with casters that are connected using a flexible connecting hose, you can pull the appliance forward up to its limit to clean the case or the floor/surface below it. This limit (usually 20") will be defined by the retaining element used to mechanically secure the appliance.
- ▷ Do not pull or otherwise subject the connections to any tension

5.2.2 How to Fully Automatically Clean the Cooking Compartment Using Canisters

For your safety when cleaning

Before starting any cleaning work, familiarize yourself with the rules, risks, and hazards specified in “*Working Safely When Cleaning* on page 98” and follow all the corresponding instructions without exception.

Procedures that you must be familiar with



You will need to be familiar with the following steps:

- Safely Opening and Closing the Appliance Door 68
- Using the Transport Trolley to Put Food Inside the Cooking Compartment and Take It Out 76
- Replacing the Rinse Aid Canister 117
- Replacing the Cleaning Agent Canister 119

Prerequisites

- You must be familiar with how to use the software to such an extent that you will be able to access and start the various cleaning profiles (please refer to the combi steamer’s operating instructions).
- All food must have been taken out from the cooking compartment. There must not be any foreign objects inside the cooking compartment.
- All bakeware, sheet pans, and shelf grills, as well as any other accessories, must have been taken out from the cooking compartment.
- The cooking compartment drain must be clear. It must not be clogged or blocked by any residues. The strainer on the oven drain must be in place.
- The appliance door’s inner glass door must be properly locked in place.
- The suction panel is properly locked in place.
- The appliance door must be closed.
- You must supply the fluids required by the cleaning program you will be using. Please refer to “*Supplying Cleaning Agents* on page 96.”
- **On table-top models with a mobile shelf rack:** The roll-in frame must be in place and the empty mobile shelf rack (or plate rack) must be inside the cooking compartment.

How to Fully Automatically Clean the Cooking Compartment Using Canisters

- | | | |
|----|---|---|
| 1. |  | Open the cleaning profile and start the cleaning sequence. |
| 2. |  | Wait until the cleaning sequence is done. |
| 3. |  | Once the cleaning sequence is done, the appliance will make a sound to let you know. Follow the software’s prompts. |

4.



- Open the appliance door and check to make sure that everything has been cleaned properly. The cooking compartment should be visibly clean and should not give off any smells typical of food leftovers or cleaning agents.
- Check the cooking compartment to make sure that no foreign objects got in during rinsing. If there are any foreign objects, remove them.
- If additional cleaning is required, clean and rinse the cooking compartment manually or by running a cleaning profile once again.

5.



Leave the appliance door ajar in order to let the cooking compartment dry out.

5.2.3 How to Fully Automatically Clean the Cooking Compartment Using the Single-Measure Dispensing Mode

For your safety when cleaning

Before starting any cleaning work, familiarize yourself with the rules, risks, and hazards specified in “*Working Safely When Cleaning* on page 98” and follow all the corresponding instructions without exception.

Procedures that you must be familiar with





You will need to be familiar with the following steps:











- Safely Opening and Closing the Appliance Door 68
- Using the Transport Trolley to Put Food Inside the Cooking Compartment and Take It Out 76
- Adding Cleaning Agent from Single-Measure Dispensing Bottles to the Inside of the Cooking Compartment 121

Prerequisites

- You must be familiar with how to use the software to such an extent that you will be able to access and start the various cleaning profiles (please refer to the combi steamer’s operating instructions).
- All food must have been taken out from the cooking compartment. There must not be any foreign objects inside the cooking compartment.
- All bakeware, sheet pans, and shelf grills, as well as any other accessories, must have been taken out from the cooking compartment.
- The cooking compartment drain must be clear. It must not be clogged or blocked by any residues. The strainer on the oven drain must be in place.
- The appliance door’s inner glass door must be properly locked in place.
- The suction panel is properly locked in place.
- The appliance door must be closed.
- You must supply the fluids required by the cleaning program you will be using. Please refer to “*Supplying Cleaning Agents* on page 96.”
- **On table-top models with a mobile shelf rack:** The roll-in frame must be in place and the empty mobile shelf rack (or plate rack) must be inside the cooking compartment.

How to Fully Automatically Clean the Cooking Compartment Using the Single-Measure Dispensing Mode

1.		Open the cleaning profile and start the cleaning sequence.
2.		Wait for the soaking stage to be done (approx. 5 – 10 minutes depending on the selected cleaning profile).
3.		<ul style="list-style-type: none"> ▪ Once the soaking stage is done, the appliance will make a sound to let you know. ▪ You will be prompted to add cleaning agent to the inside. ▪ The software will indicate how many single-measure dispensing bottles are needed.
4.		Open the appliance door.

5.		<p>Add cleaning agent from the single-measure dispensing bottles to the inside of the cooking compartment. If necessary, remove the mobile shelf rack from the cooking compartment to do so and then slide the shelf rack back in.</p>
6.		<p>Close the appliance door.</p>
7.		<p>Wait for the cleaning stage to be done (approx. 30 – 60 minutes depending on the selected cleaning profile).</p>
		<p>If you are using easyTouch controls and you select the “Express” cleaning duration, skip steps 8 through 12.</p>
8.		<ul style="list-style-type: none"> ▪ Once the cleaning stage is done, the appliance will make a sound to let you know. ▪ You will be prompted to add rinse aid to the inside. ▪ The software will indicate how many single-measure dispensing bottles are needed. <p>In exceptional cases, you can skip adding rinse aid depending on the water hardness and the degree of scale build-up in the appliance.</p>
9.		<p>Open the appliance door.</p>
10.		<p>Add rinse aid from the single-measure dispensing bottles to the inside of the cooking compartment. If necessary, remove the mobile shelf rack from the cooking compartment to do so and then slide the shelf rack back in.</p>
11.		<p>Close the appliance door.</p>
12.		<p>Wait for the last cleaning stage to be done (approx. 20 – 30 minutes depending on the selected cleaning profile).</p>
13.		<ul style="list-style-type: none"> ▪ Once the last cleaning stage is done, the appliance will make a sound to let you know. ▪ Follow the software’s prompts.
14.		<ul style="list-style-type: none"> ▪ Open the appliance door and check to make sure that everything has been cleaned properly. The cooking compartment should be visibly clean and should not give off any smells typical of food leftovers or cleaning agents. ▪ Check the cooking compartment to make sure that no foreign objects got in during rinsing. If there are any foreign objects, remove them. ▪ If additional cleaning is required, clean and rinse the cooking compartment manually or by running a cleaning profile once again.
15.		<p>Leave the appliance door ajar in order to let the cooking compartment dry out.</p>

5.2.4 How to Semi-Automatically Clean the Cooking Compartment in Table-Top Models with Racks

For your safety when cleaning

Before starting any cleaning work, familiarize yourself with the rules, risks, and hazards specified in “*Working Safely When Cleaning* on page 98” and follow all the corresponding instructions without exception.

Procedures that you must be familiar with





You will need to be familiar with the following steps:











- Safely Opening and Closing the Appliance Door 68
- Removing and Installing the Racks 83
- Releasing the Suction Panel and Locking it Back in Place 123

Prerequisites

- You must be familiar with how to use the software to such an extent that you will be able to access and start the various cleaning profiles (please refer to the combi steamer’s operating instructions).
- All food must have been taken out from the cooking compartment. There must not be any foreign objects inside the cooking compartment.
- All bakeware, sheet pans, and shelf grills, as well as any other accessories, must have been taken out from the cooking compartment.
- The cooking compartment drain must be clear. It must not be clogged or blocked by any residues. The strainer on the oven drain must be in place.
- The appliance door’s inner glass door must be properly locked in place.
- The suction panel is properly locked in place.
- The appliance door must be closed.
- You must supply the fluids required by the cleaning program you will be using. Please refer to “*Supplying Cleaning Agents* on page 96.”

How to Semi-Automatically Clean the Cooking Compartment in Table-Top Models with Racks

1.		Open the cleaning profile and start the cleaning sequence.
2.		Wait for the soaking stage to be done (approx. 10 minutes).
3.		Once the soaking stage is done, the appliance will make a sound to let you know. You will be prompted to spray cleaning agent inside.
4.		Open the appliance door.
5.		Swing the rack and the suction panel towards the inside of the cooking compartment.

6.		<p>Spray the cooking compartment, the suction panel and the area behind it, the racks, and the cooking compartment drain with the cleaning agent inside the spray bottle.</p>
7.		<p>Lock the suction panel and the racks back in place.</p>
8.		<p>Close the appliance door.</p>
9.		<p>Wait for the cleaning stage to be done (approx. 10 minutes).</p>
10.		<p>Once the cleaning stage is done, the appliance will make a sound to let you know. You will be prompted to rinse out the cooking compartment.</p>
11.		<p>Open the appliance door.</p>
12.		<p>Swing the rack and the suction panel towards the inside of the cooking compartment once again.</p>
13.		<p>Thoroughly rinse the cooking compartment, all accessories, the area behind the suction panel, and the cooking compartment drain with the spray head.</p> <p>WARNING! Risk of food being contaminated by cleaning agent or rinse aid if the appliance is not completely rinsed out</p> <ul style="list-style-type: none"> ▪ If the appliance does not have a pullout spray head, use an external water jet to rinse out the appliance or thoroughly wipe the cooking compartment, the accessories, and the area behind the suction panel with plenty of water and a soft cloth.
14.		<p>Check to make sure that everything has been cleaned properly. The cooking compartment should be visibly clean and should not give off any smells typical of food leftovers or cleaning agents. If additional cleaning is required, clean and rinse the cooking compartment manually or by running a cleaning profile once again.</p>
15.		<p>Lock the suction panel and the racks back in place.</p>
16.		<p>Leave the appliance door ajar in order to let the cooking compartment dry out.</p>

5.2.5 How to Semi-Automatically Clean the Cooking Compartment in Table-Top Models with a Mobile Shelf Rack

For your safety when cleaning

Before starting any cleaning work, familiarize yourself with the rules, risks, and hazards specified in “*Working Safely When Cleaning* on page 98” and follow all the corresponding instructions without exception.

Procedures that you must be familiar with





You will need to be familiar with the following steps:













- Safely Opening and Closing the Appliance Door 68
- Using the Transport Trolley to Put Food Inside the Cooking Compartment and Take It Out 76
- Releasing the Suction Panel and Locking it Back in Place 123





Prerequisites

- You must be familiar with how to use the software to such an extent that you will be able to access and start the various cleaning profiles (please refer to the combi steamer’s operating instructions).
- All food must have been taken out from the cooking compartment. There must not be any foreign objects inside the cooking compartment.
- All bakeware, sheet pans, and shelf grills, as well as any other accessories, must have been taken out from the cooking compartment.
- The cooking compartment drain must be clear. It must not be clogged or blocked by any residues. The strainer on the oven drain must be in place.
- The roll-in frame must be in place and the empty mobile shelf rack (or plate rack) must be inside the cooking compartment.
- The appliance door’s inner glass door must be properly locked in place.
- The suction panel is properly locked in place.
- The appliance door must be closed.
- You must supply the fluids required by the cleaning program you will be using. Please refer to “*Supplying Cleaning Agents* on page 96.”

How to Semi-Automatically Clean the Cooking Compartment in Table-Top Models with a Mobile Shelf Rack

1.		Open the cleaning profile and start the cleaning sequence.
2.		Wait for the soaking stage to be done (approx. 10 minutes).
3.		Once the soaking stage is done, the appliance will make a sound to let you know. You will be prompted to spray cleaning agent inside.
4.		Open the appliance door.
5.		Remove the mobile shelf rack (or plate rack) and the roll-in frame.

6.		Swing the suction panel towards the inside of the cooking compartment.
7.		Spray the cooking compartment, the suction panel, the area behind the suction panel, and the cooking compartment drain with the cleaning agent inside the spray bottle.
8.		Lock the suction panel back in place.
9.		Place the roll-in frame back in and move the mobile shelf rack (or plate rack) back in.
10.		Spray the mobile shelf rack (or plate rack) and the roll-in frame with the cleaning agent inside the spray bottle.
11.		Close the appliance door.
12.		Wait for the cleaning stage to be done (approx. 10 minutes).
13.		Once the cleaning stage is done, the appliance will make a sound to let you know. You will be prompted to rinse out the cooking compartment.
14.		Open the appliance door.
15.		Thoroughly rinse the mobile shelf rack (or plate rack) and the roll-in frame with the spray head.
16.		Remove the mobile shelf rack (or plate rack) and the roll-in frame.
17.		Swing the suction panel towards the inside of the cooking compartment.

<p>18.</p>		<p>Thoroughly rinse the cooking compartment, the suction panel, the area behind the suction panel, and the cooking compartment drain with the spray head.</p> <p>WARNING! Risk of food being contaminated by cleaning agent or rinse aid if the appliance is not completely rinsed out</p> <ul style="list-style-type: none"> ▪ If the appliance does not have a pullout spray head, use an external water jet to rinse out the appliance or thoroughly wipe the cooking compartment, the accessories, and the area behind the suction panel with plenty of water and a soft cloth.
<p>19.</p>		<p>Lock the suction panel back in place.</p>
<p>20.</p>		<p>Place the roll-in frame back in and move the mobile shelf rack (or plate rack) back in.</p>
<p>21.</p>		<p>Check to make sure that everything has been cleaned properly. The cooking compartment should be visibly clean and should not give off any smells typical of food leftovers or cleaning agents.</p> <p>If additional cleaning is required, clean and rinse the cooking compartment manually or by running a cleaning profile once again.</p>
<p>22.</p>		<p>Leave the appliance door ajar in order to let the cooking compartment dry out.</p>

5.2.6 How to Clean the Cooking Compartment Without Using Cleaning Agents

For your safety when cleaning

Before starting any cleaning work, familiarize yourself with the rules, risks, and hazards specified in “*Working Safely When Cleaning* on page 98” and follow all the corresponding instructions without exception.

Procedures that you must be familiar with





You will need to be familiar with the following steps:

- Safely Opening and Closing the Appliance Door 68
- Using the Transport Trolley to Put Food Inside the Cooking Compartment and Take It Out 76
- Putting Away and Removing the Core Temperature Probe 81

Prerequisites

- You must be familiar with how to use the software to such an extent that you will be able to access and start the various cleaning profiles (please refer to the combi steamer’s operating instructions).
- All food must have been taken out from the cooking compartment. There must not be any foreign objects inside the cooking compartment.
- The cooking compartment drain must be clear. It must not be clogged or blocked by any residues. The strainer on the oven drain must be in place.
- The appliance door’s inner glass door must be properly locked in place.
- The suction panel is properly locked in place.
- The appliance door must be closed.
- **On table-top models with a mobile shelf rack:** The roll-in frame must be in place and the mobile shelf rack (or plate rack) must be inside the cooking compartment.

How to Clean the Cooking Compartment Without Using Cleaning Agents

- | | | |
|----|---|---|
| 1. |  | Open the cleaning profile and start the cleaning sequence. |
| 2. |  | Wait until the cleaning sequence is done. |
| 3. |  | Once the cleaning sequence is done, the appliance will make a sound to let you know. Follow the software’s prompts. |
| 4. |  | <ul style="list-style-type: none"> ▪ Open the appliance door and check to make sure that everything has been cleaned properly. ▪ Check the cooking compartment to make sure that no foreign objects got in during rinsing. If there are any foreign objects, remove them. ▪ If necessary, clean and rinse the cooking compartment manually or by running a different cleaning profile. |
| 5. |  | Leave the appliance door ajar in order to let the cooking compartment dry out. |

5.2.7 How to Clean the Double Glass Door

⚠ For your safety when cleaning

Before starting any cleaning work, familiarize yourself with the rules, risks, and hazards specified in “*Working Safely When Cleaning* on page 98” and follow all the corresponding instructions without exception.

Procedures that you must be familiar with





You will need to be familiar with the following steps:

- Safely Opening and Closing the Appliance Door 68
- Releasing the Inner Glass Door and Locking it Back in Place 127

Prerequisites

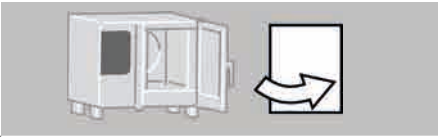
- You must have the necessary cleaning agent, common household glass cleaner, ready.
- You must have several (at least three) clean, soft cloths ready.
- The appliance door must have already cooled down to room temperature.

How to Clean the Double Glass Door

- | | | |
|----|---|--|
| 1. |  | Open the appliance door and swing the double glass door's inner pane out. |
| 2. |  | Clean both sides of the double glass door's inner pane and outer pane with a soft, clean cloth and the cleaning agent
Make sure not to scratch the glass. |
| 3. |  | Wipe both sides of the double glass door's inner pane and outer pane with a soft, clean cloth and water. |
| 4. |  | Dry both sides of the double glass door's inner pane and outer pane with a soft, clean cloth. |
| 5. |  | Swing the appliance door's inner pane back in place and lock it into place. |

5.2.8 How to Clean the Cooking Compartment Section Behind the Suction Panel

For your safety when cleaning

Before starting any cleaning work, familiarize yourself with the rules, risks, and hazards specified in “*Working Safely When Cleaning* on page 98” and follow all the corresponding instructions without exception.

Procedures that you must be familiar with



You will need to be familiar with the following steps:

- Safely Opening and Closing the Appliance Door 68
- Removing and Installing the Racks 83
- Using the Transport Trolley to Put Food Inside the Cooking Compartment and Take It Out 76
- Releasing the Suction Panel and Locking it Back in Place 123

Prerequisites

- You must supply the required cleaning agent, ConvoClean new or ConvoClean forte, in the spray bottle. Please refer to “*Supplying Cleaning Agents* on page 96.”
- The cooking compartment drain must be clear. It must not be clogged or blocked by any residues.
- **On table-top models with racks:** The left rack must have been removed.
- **On table-top models with a mobile shelf rack:** The mobile shelf rack and the roll-in frame must have been taken out from the cooking compartment.

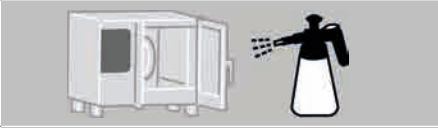
How to Clean the Cooking Compartment Section Behind the Suction Panel

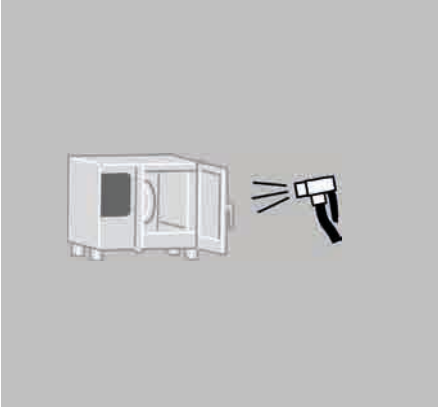
1.		Swing the suction panel towards the inside of the cooking compartment.
2.		Spray the suction panel on all sides and the area behind it with the cleaning agent in the spray bottle.
3.		Let the cleaning agent work for 10 – 20 minutes.
4.		<p>Thoroughly rinse the suction panel on all sides, the area behind it, and the entire cooking compartment with the spray head. You can repeat the cleaning sequence if there is heavy soiling.</p> <p>WARNING! Risk of food being contaminated by cleaning agent or rinse aid if the appliance is not completely rinsed out</p> <ul style="list-style-type: none"> ▪ If the appliance does not have a pullout spray head, use an external water jet to rinse out the appliance or thoroughly wipe the cooking compartment, the accessories, and the area behind the suction panel with plenty of water and a soft cloth.

5 How to Clean the Combi Steamer

5.



Lock the suction panel back in place.

6.



Leave the appliance door ajar in order to let the cooking compartment dry out.

5.2.9 How to Clean the Hygienic Plug-In Gasket Thoroughly

⚠ For your safety when cleaning

Before starting any cleaning work, familiarize yourself with the rules, risks, and hazards specified in “*Working Safely When Cleaning* on page 98” and follow all the corresponding instructions without exception.

Procedures that you must be familiar with







You will need to be familiar with the following steps:

- Safely Opening and Closing the Appliance Door 68
- Removing and Installing the Hygienic Plug-In Gasket 126

Prerequisites

- You must have the necessary cleaning agent, common household dishwashing liquid, ready.
- You must have several (at least three) clean, soft cloths ready.

How to Clean the Hygienic Plug-In Gasket Thoroughly

- | | | |
|----|---|---|
| 1. |  | Open the appliance door and remove the hygienic plug-in gasket. |
| 2. |  | Clean the hygienic plug-in gasket with a soft, clean cloth and cleaning agent in a sink. |
| 3. |  | Rinse the hygienic plug-in gasket with a soft, clean cloth and water in a sink. |
| 4. |  | Thoroughly dry the hygienic plug-in gasket with a soft, clean cloth. |
| 5. |  | Put the hygienic plug-in gasket back around the cooking compartment. |
| 6. |  | Leave the appliance door ajar in order to let the hygienic plug-in gasket dry out completely. |

5.3 Specific Cleaning Instructions

Contents

This section covers the following subjects:

	Page
Safely Using the Appliance	115
Replacing the Rinse Aid Canister	117
Replacing the Cleaning Agent Canister	119
Adding Cleaning Agent from Single-Measure Dispensing Bottles to the Inside of the Cooking Compartment	121
Releasing the Suction Panel and Locking it Back in Place	123
Removing and Installing the Hygienic Plug-In Gasket	126
Releasing the Inner Glass Door and Locking it Back in Place	127



5.3.1 Safely Using the Appliance

For your and your employees' safety

Every person (user) must read and understand the contents in the “*For Your Safety* on page 21” section before they work with or on the combi steamer for the first time. In addition, every user must follow the instructions and warnings in said section at all times.

As the combi steamer's owner, or as the owner's employee responsible for the staff who will be using the combi steamer, set the necessary rules and brief all new employees.

Every user must read and understand the safe work rules specified in this section before starting any work and follow them without exception.

Every user must read and understand the risks and hazards described in this section and in the following instructions before starting any work and follow the corresponding safety instructions without exception.

Personal protective equipment for all users

As a user, you must wear the personal protective equipment specified for your work in the “*Personal Protective Equipment* on page 46” section of “*For Your Safety*.”

Hot surfaces

▲WARNING

Risk of burns posed by high temperatures on the appliance's interior and exterior parts.

Touching any interior cooking compartment parts, the inside of the appliance door, or any parts that are or were found inside the cooking compartment during cooking may result in burns. Touching the exhaust vent and exhaust outlet may also result in burns.

- ▷ Before performing any cleaning work, wait until the cooking compartment has cooled down to a temperature lower than 60 °C or cool it down with the “Cool down” function
- ▷ Wear the required personal protective equipment.

Contact with cleaning agents

▲WARNING

Chemical burn hazard and skin, eye, and respiratory tract irritation hazard

The ConvoClean new (S) cleaning agent and the ConvoCare (S) rinse aid will cause skin, eye, and respiratory tract irritation upon direct contact. The ConvoClean forte (S) cleaning agent will result in chemical burns to the skin, eyes, and respiratory tract upon direct contact.

- ▷ Do not inhale the cleaning agents' and rinse aid's vapors or mist.
- ▷ Do not let the cleaning agents or rinse aid come into contact with your eyes, skin, or mucous membranes.
- ▷ Do not spray cleaning agents or rinse aid into a cooking compartment that is at a temperature higher than 140 °F, as doing so will cause more caustic and/or irritating cleaning-fluid vapors to be produced.
- ▷ If the canisters are connected, do not open the appliance door during the fully automatic oven cleaning process.
- ▷ If using single-measure dispensing, do not open the appliance door during the fully automatic oven cleaning process UNTIL asked to do so by the software.
- ▷ Wear the required personal protective equipment.

Leaking gas

⚠ DANGER

Explosion hazard posed by gas leaks

Gas leaks may result in an explosion in the presence of an ignition source.

- ▷ In the case of appliances on a base with casters that are connected using a flexible connecting hose, you can pull the appliance forward up to its limit to clean the case or the floor/surface below it. This limit (usually 20") will be defined by the retaining element used to mechanically secure the appliance.
- ▷ Do not pull or otherwise subject the connections to any tension

5.3.2 Replacing the Rinse Aid Canister

⚠ For your safety when using the appliance

Before starting work, read and understand the rules, risks, and hazards specified in “*Safely Using the Appliance* on page 115” and follow all the corresponding instructions without exception.

Required tools

- One empty canister (10 l) for ConvoCare rinse aid
- Enough (around 10 l) soft water (for specifications, please refer to the “*Water Quality*” sub-section of the “*Technical Data*” section in the installation manual)
- ConvoCare K concentrate (0.33 l)

Preparing ConvoCare rinse aid in the canister

To prevent undesired foaming, follow the steps below when preparing rinse aid with ConvoCare K concentrate and soft water:

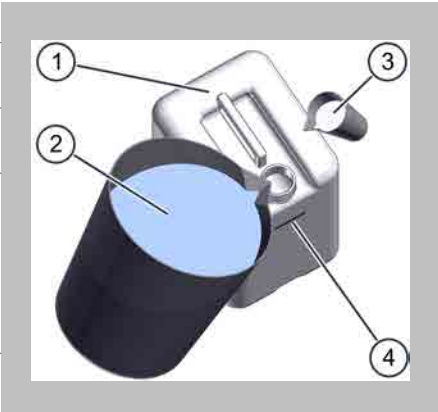
- | | | |
|----|--|--|
| 1. |  | Open the empty canister (1). |
| 2. | | Fill the canister with soft water (2) all the way to just under the 10-liter marking (4). |
| 3. | | Then carefully pour 0.33 l of ConvoCare K concentrate (3) into the canister (1). |
| 4. | | Check the liquid level inside the canister: <ul style="list-style-type: none"> ▪ If the level is below the 10-liter marking (4), carefully add the required amount of soft water (2). ▪ If the level is above the 10-liter marking (4), the rinse aid’s concentration will be lower than specified. You can still use the rinse aid if this is the case! |
| 5. | | Close the canister and mix the liquids thoroughly by shaking it. |

Replacing the rinse aid canister

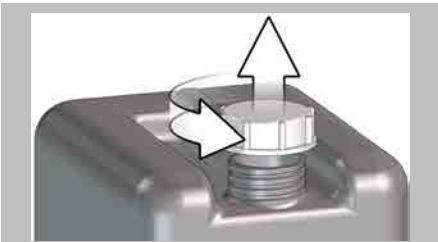
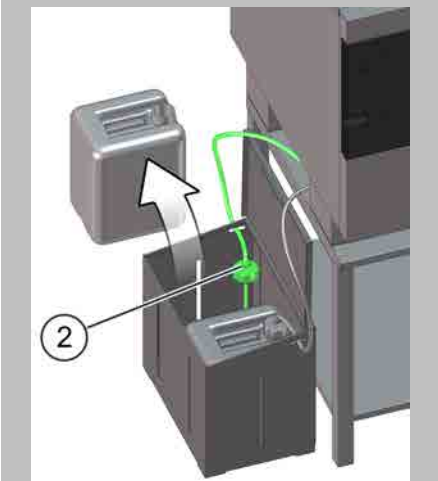
- | | | |
|----|---|--|
| 1. |  | Remove the cap from the canister in which you prepared ConvoCare rinse aid. |
| 2. |  | <ul style="list-style-type: none"> ▪ Find the canister that is connected to the rinse aid connection (F) with a (green) tube and that is located on the bottom left side of the appliance. ▪ Unscrew the (green) supply tube (2), together with the wand, from the canister you just identified. ▪ Remove the empty rinse aid canister. |

3.

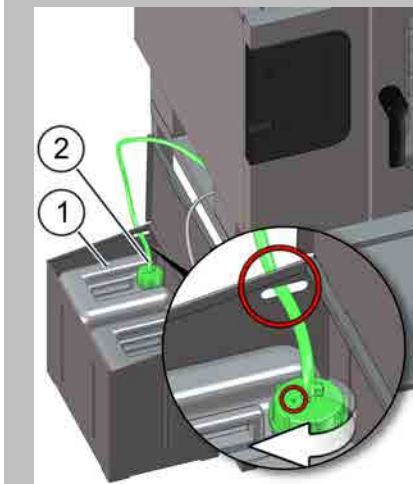

- Put the new, full canister (1) containing rinse aid in place.
- Insert the (green) supply tube, together with the wand (2), into the full canister (1) and screw it in place.
- Make sure that the tube is routed without any kinks and that the vent opening on the canister's cap is open and clear.

4.

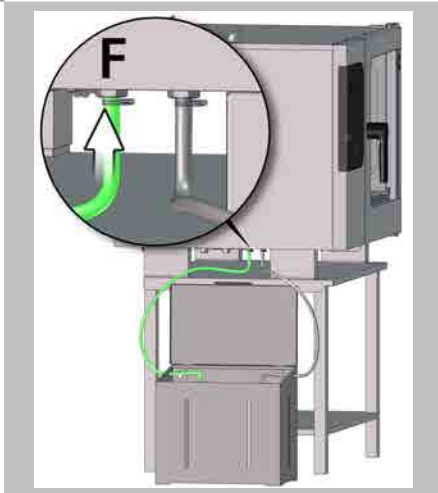

- Check to make sure that the canisters are set up correctly:
 - The canisters' location must be lower than the level at which the appliance is resting on its base.
 - The contact point between the canisters and their supporting surface must not be more than 40 inches below the bulkhead fittings.
- Check to make sure that the tube is connected to the right connection.
 - The rinse aid must go to appliance connection F (indicated by a green color).

5.3.3 Replacing the Cleaning Agent Canister

⚠ For your safety when using the appliance

Before starting work, read and understand the rules, risks, and hazards specified in “*Safely Using the Appliance* on page 115” and follow all the corresponding instructions without exception.

Required tools

- Replacement ConvoClean new or ConvoClean forte canister

Replacing the Cleaning Agent Canister

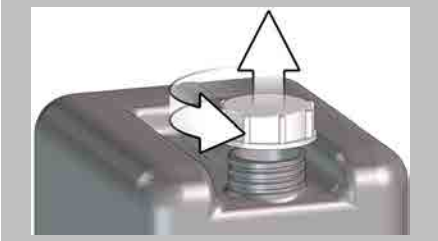
- 

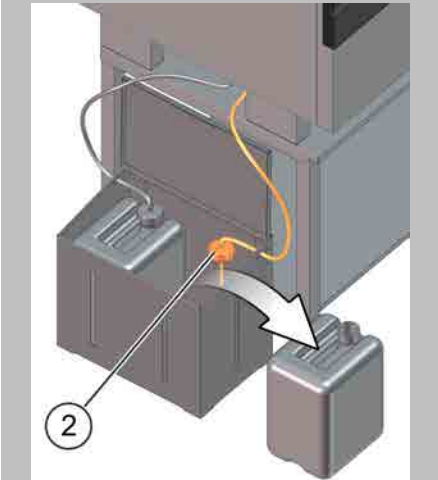
1. Remove the cap from the ConvoClean new or ConvoClean forte replacement canister.
- 
 - Find the canister that is connected to the cleaning agent connection (G) with a (red) tube and that is located on the bottom left side of the appliance.
 - Unscrew the (red) supply tube (2), together with the wand, from the canister you just identified.
 - Remove the empty cleaning agent canister.

3.



- Put the new, full canister (1) containing cleaning agent in place.
- Insert the (red) supply tube, together with the wand (2), into the full canister (1) and screw it in place.
- Make sure that the tube is routed without any kinks and that the vent opening on the canister's cap is open and clear.

4.

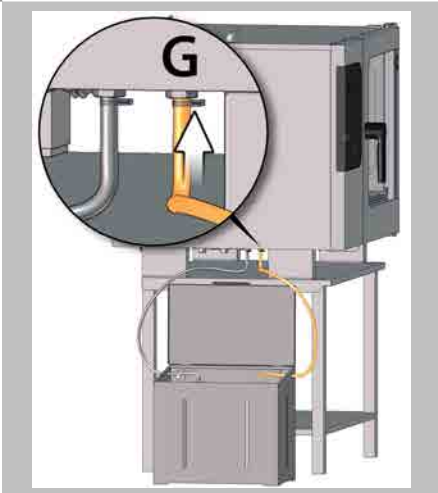

- Check to make sure that the canisters are set up correctly:
 - The canisters' location must be lower than the level at which the appliance is resting on its base.
 - The contact point between the canisters and their supporting surface must not be more than 40 inches below the bulkhead fittings.
- Check to make sure that the tube is connected to the right connection.
 - The cleaning agent must go to appliance connection G (indicated by a red color).

5.3.4 Adding Cleaning Agent from Single-Measure Dispensing Bottles to the Inside of the Cooking Compartment

For your safety when using the appliance

Before starting work, read and understand the rules, risks, and hazards specified in “*Safely Using the Appliance* on page 115” and follow all the corresponding instructions without exception.

Procedures that you must be familiar with

You will need to be familiar with the following steps:

- Safely Opening and Closing the Appliance Door 68
- Supplying Cleaning Agents 96

Prerequisites

- You must have started a cleaning profile that uses fully automatic oven cleaning with single-measure dispensing. The software has prompted you to add either cleaning agent or rinse aid from a single-measure dispensing bottle to the inside of the cooking compartment.
- You must have the necessary single-measure dispensing bottles containing cleaning agent and rinse aid ready to go as required by the cleaning program you are using. Please refer to “*Supplying Cleaning Agents* on page 96.”

Adding Cleaning Agent from Single-Measure Dispensing Bottles to the Inside of the Cooking Compartment

1.

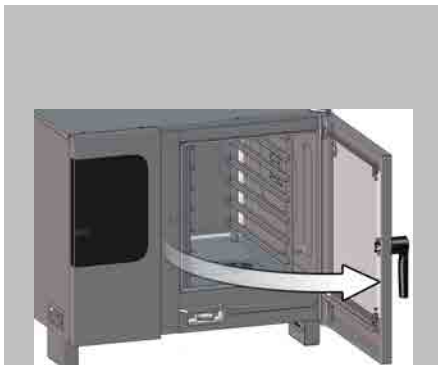

- Do not open the appliance door until you are prompted to do so by the software during the fully automatic oven cleaning sequence.
- Follow the software’s prompts.
- Depending on where in the cleaning sequence you are, grab a single-measure dispensing bottle with cleaning agent **or** a single-measure dispensing bottle with rinse aid.

WARNING! Chemical burn hazard and skin, eye, and respiratory tract irritation hazard

- Be careful not to come into contact with cleaning agent or rinse aid when dispensing the contents of the single-measure dispensing bottles into the cooking compartment.
- Wear the required personal protective equipment.

2.

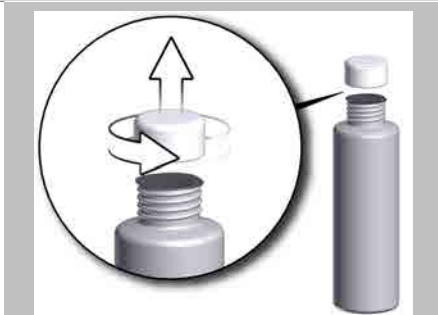

- Unscrew the single-measure dispensing bottle’s cap.
- Make sure that the seal on the bottle remains undamaged.

3.

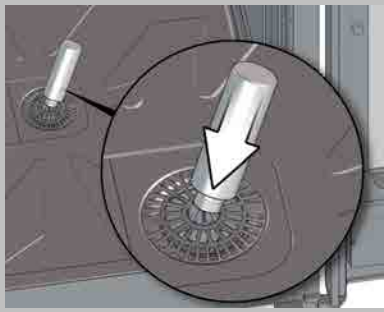

Vertically push the bottle into the pointed tip at the center of the cooking compartment drain so that the tip will pierce the seal.

4.

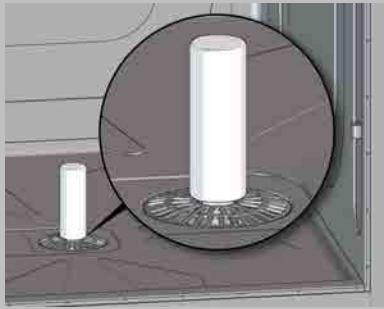

- Let the bottle sit vertically on the pointed tip for about 10 seconds so that there will be enough time for all the liquid to come out.
- Visually check whether all the liquid has come out. The single-measure dispensing bottle is made of a transparent material that makes it possible to see whether there is any liquid still inside.
- If necessary, squeeze the remaining liquid out of the single-measure dispensing bottle while it is still on the pointed tip.

5.

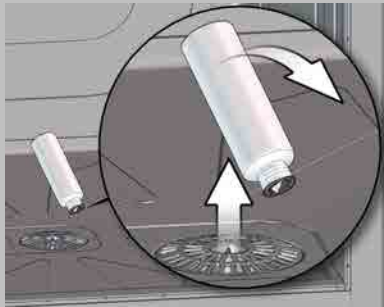

- Once you are done, carefully remove the bottle from the pointed tip.
- Remove the bottle from the cooking compartment.
- Repeat steps 2 through 5 if the software prompts you to use more than one single-measure dispensing bottle to add cleaning agent or rinse aid to the inside of the cooking compartment.

WARNING! Risk of food being contaminated by cleaning agent or rinse aid

- Make sure that the work surface does not come into contact with cleaning agent or rinse aid.
- Do not put empty single-measure dispensing bottles down on the work surface, as drops of cleaning agent or rinse aid may run down along the outside of the bottles.

6.

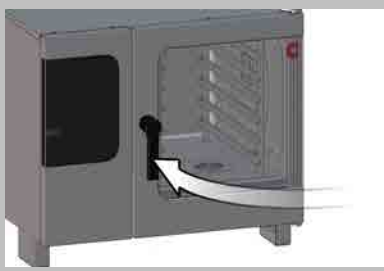

Close the appliance door.

5.3.5 Releasing the Suction Panel and Locking it Back in Place

⚠ For your safety when using the appliance

Before starting work, read and understand the rules, risks, and hazards specified in “*Safely Using the Appliance* on page 115” and follow all the corresponding instructions without exception.

Procedures that you must be familiar with

You will need to be familiar with the following steps:

- Safely Opening and Closing the Appliance Door 68
- Removing and Installing the Racks 83
- Using the Transport Trolley to Put Food Inside the Cooking Compartment and Take It Out 76

Required tools

A suitable tool, e.g., a flat blade screwdriver for releasing the latches

Prerequisites

- The cooking compartment must have cooled down to a temperature of less than 140 °F since the last time it was used.
- **On table-top models with racks:** The left rack must have been removed.
- **On table-top models with a mobile shelf rack:** The mobile shelf rack and the roll-in frame must have been taken out from the cooking compartment.

Releasing and swinging out the suction panel

1.

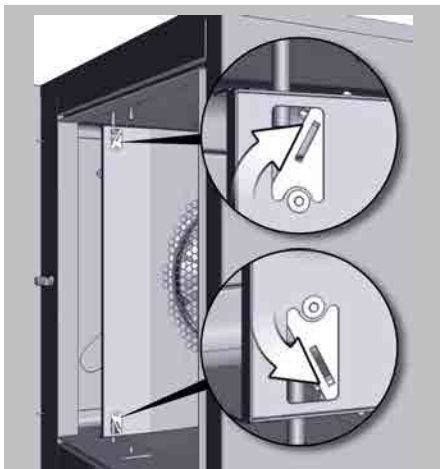

Release the upper and lower latches with the tool.

2.

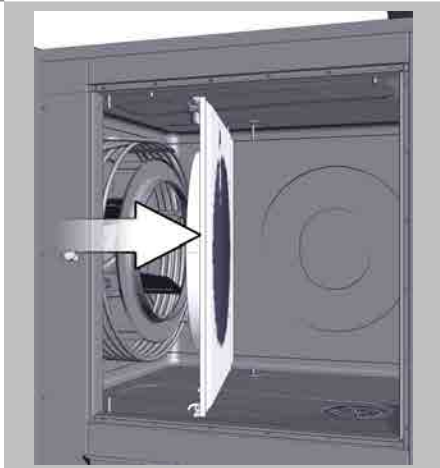

Swing the suction panel towards the inside of the cooking compartment.

Locking the suction panel in place

1.

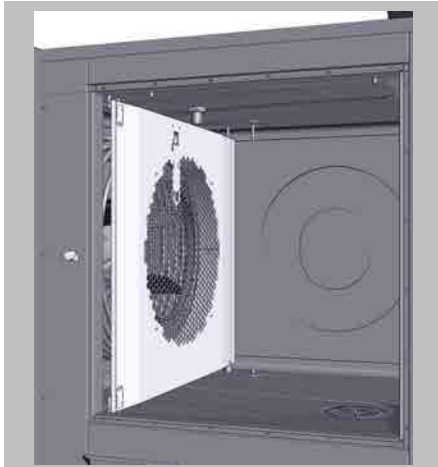

Follow the same steps used to release and swing out the suction panel, but in opposite order.

2.

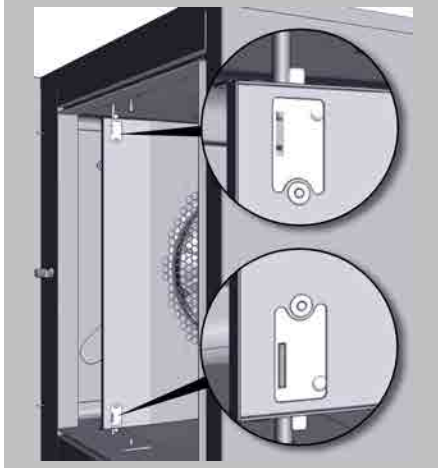

Check to make sure that the upper and lower latches are engaged.

5.3.6 Removing and Installing the Hygienic Plug-In Gasket

⚠ For your safety when using the appliance

Before starting work, read and understand the rules, risks, and hazards specified in “*Safely Using the Appliance* on page 115” and follow all the corresponding instructions without exception.

Procedures that you must be familiar with

You will need to be familiar with the following steps:

- Safely Opening and Closing the Appliance Door

68

Prerequisites

- The combi steamer must have cooled down to a temperature of less than 140 °F since the last time it was used.
- The appliance door must be open.

Removing the hygienic plug-in gasket

1.

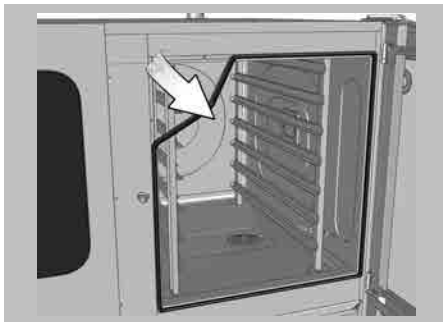

Pull out the hygienic plug-in gasket around the appliance door opening. Start from the corners.

Installing the hygienic plug-in gasket

1.

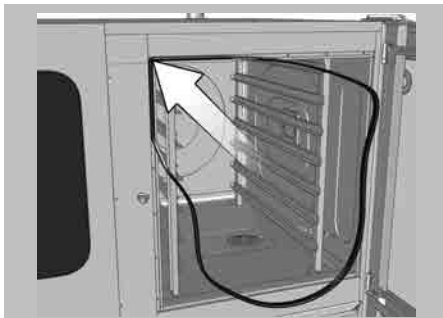

Start by putting the hygienic plug-in gasket back in place at all four corners. Start from one of the upper corners.

2.

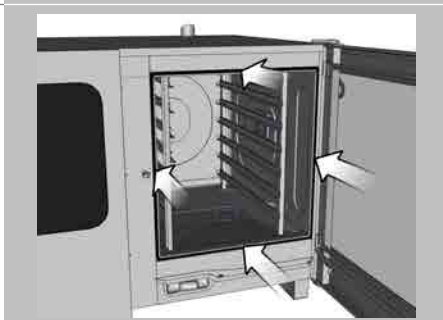

Once all four corners are in place, meticulously press the hygienic plug-in gasket into the rest of the guide. Make sure that the hygienic plug-in gasket is resting solidly against the guide and that there are no bends or kinks in it.

5.3.7 Releasing the Inner Glass Door and Locking it Back in Place

⚠ For your safety when using the appliance

Before starting work, read and understand the rules, risks, and hazards specified in “*Safely Using the Appliance* on page 115” and follow all the corresponding instructions without exception.

Procedures that you must be familiar with

You will need to be familiar with the following steps:

- Safely Opening and Closing the Appliance Door

68

Prerequisites

The cooking compartment must have cooled down to a temperature of less than 140 °F since the last time it was used.

Releasing and swinging out the inner glass door

1.  Open the appliance door.

2.  Push the upper and lower spring clips back.

3.  Swing the inner pane out.

Locking the inner glass door in place

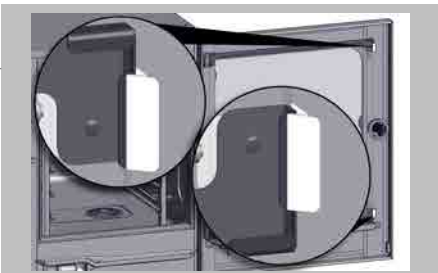
1.  Follow the same steps used to release and swing out the inner glass door, but in opposite order.

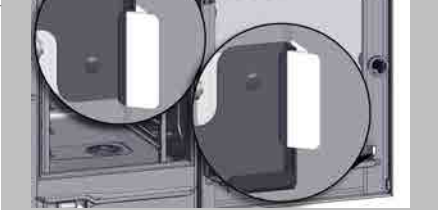
2.  Check to make sure that the upper and lower spring clips are holding the inner glass correctly in position. Do not close the appliance door until they are!

6 How to Perform Maintenance on the Combi Steamer

Purpose of this section

This section goes over the maintenance work that needs to be performed on the combi steamer, as well as the corresponding intervals.

It goes over how to handle and use the combi steamer when performing maintenance on it and what kind of steps you need to follow.

In addition, it provides an overview of potential appliance faults and errors that can occur during operation.

Contents

This section covers the following subjects:

	Page
Maintenance Basics	129
Troubleshooting	132
Maintenance work	138

6.1 Maintenance Basics

Contents

This section covers the following subjects:

	Page
Warranty Information / How to Contact Customer Service	130
Maintenance schedule	131

6.1.1 Warranty Information / How to Contact Customer Service

Warranty information

Warranty claims involving your combi steamer will only be honored if the appliance has been installed by a qualified service technician from an authorized service company as per the instructions in the installation manual. Please note that warranty claims will only be honored if the manufacturer has a copy of the fully completed checklist from the installation manual.

The warranty will be void if there is any damage that can be traced back to improper setup, installation, use, cleaning, use of cleaning agents, maintenance, repair, or descaling.

In order to get a two-year extended warranty for spare parts, the appliance needs to be registered on the manufacturer's website (www.convotherm.de) after installation.

Required information

Please have the following appliance information ready when contacting Customer Service:

- The appliance's item number (please refer to "*Identifying Your Combi Steamer* on page 9")
- The appliance's serial number (please refer to "*Identifying Your Combi Steamer* on page 9")

Contact information

Convotherm Elektrogeräte GmbH

Ovens & Advanced Cooking EMEA, Manitowoc Foodservice
 Talstraße 35
 82436 Eglfing
 Germany

Reception Desk

Phone (headquarters)	(+49) (0) 8847 67-0
----------------------	---------------------

Fax	(+49) (0) 8847 414
-----	--------------------

Website	www.convotherm.com www.manitowocfoodservice.com
----------------	--

Application Support

Hotline	(+49) (0) 8847 67-899
---------	-----------------------

e-mail	con-dl-chefshotline@manitowoc.com con-dl-anwendungsberatung@manitowoc.com
--------	--

Sales

e-mail for appliances/accessories	con.verkaufsabwicklung@manitowoc.com
-----------------------------------	--

e-mail for spare parts	convotherm-spare@manitowoc.com
------------------------	--

Customer Service

Technical Hotline (office hours)	(+49) (0) 8847 67 541
----------------------------------	-----------------------

Technical Hotline (outside office hours)	(+49) (0) 175 405 41 09
--	-------------------------

e-mail	convotherm-service@manitowoc.com
--------	--

6.1.2 Maintenance schedule

Prerequisites

Customer Service must perform maintenance work on a regular basis.

Maintenance work that can be carried out by the operator.

What needs to be serviced?	When?	Required parts
Replacing the hygienic plug-in gasket	When the hygienic plug-in gasket has cracks or is greasy	As specified in the parts list: One (1) hygienic plug-in gasket
Replacing the oven light halogen lamp	When the halogen lamp does not light up anymore in any operating state	As specified in the parts list: One (1) 12 V halogen lamp

Maintenance that must be performed by Customer Service

What needs to be serviced?	How often? / When?
General maintenance	Annually
The water treatment system needs to be readjusted	If there is a white film inside the cooking compartment
Boiler descaling	Upon request

6.2 Troubleshooting

Contents

This section covers the following subjects:

	Page
Troubleshooting – Error Codes	133
Emergency Mode	134
Troubleshooting – Problems During Operation	136

6.2.1 Troubleshooting – Error Codes

Errors and required responses

The following table lists the errors that you will be able to fix yourself under certain circumstances. If the combi steamer keeps showing the error even after you attempt to fix it, contact Customer Service. If any error messages other than the ones listed here appear, contact Customer Service.

Error No.	Error description	Required response
E01.x	Not enough water	Open the water hookup valve
E02	El. temperature too high	<ul style="list-style-type: none"> ▪ Clean the lint screen on the bottom of the appliance ▪ Clear the area around the air intake on the bottom of the appliance
E03.x	Fan fault	Check the fuse/circuit breaker in the building's load center
E34.0	Boiler pump fault	Disconnect the appliance from the outlet for approx. 10 seconds and restart it
E61.0	Cleaning: steam fault	Disconnect the appliance from the outlet for approx. 10 seconds and restart it
E62.0	Pressure switch fault	Disconnect the appliance from the outlet for approx. 10 seconds and restart it
E63.0	Pressure switch fault	Disconnect the appliance from the outlet for approx. 10 seconds and restart it
E81.0	Cooking mode error	<ul style="list-style-type: none"> ▪ Write the cooking profile again ▪ Import the cooking profile backed up on the IDM
E89.x	IDM fault	Turn off the appliance and then turn it back on
E91.x	SD error	Turn off the appliance and then turn it back on
E92.x	SD error	Turn off the appliance and then turn it back on
E96.0	Connection error	Disconnect the appliance from the outlet for approx. 10 seconds and restart it
E99	Communications dropped out	Disconnect the appliance from the outlet for approx. 10 seconds and restart it
E99.9	Initialization error	Disconnect the appliance from the outlet for approx. 10 seconds and restart it

6.2.2 Emergency Mode

Running the combi steamer in emergency mode

The combi steamer features an emergency mode in order to allow you to keep using it if there is an error or fault that cannot be fixed right away.

This mode will let you keep running the appliance (with a number of limitations) even when there is a malfunction.

Always notify Customer Service!

Prerequisites

- The appliance is malfunctioning.
- An acoustic signal is emitted.
- An error code is shown on the display.

Running the appliance in emergency mode

- 





Confirm the error being displayed and start a cooking or cleaning profile that uses an available operating mode.





Limitations

- Cooking times may be longer and cooking results may be uneven. Because of this, pay special attention to the cooking sequence and to how well-cooked your product is.
- The appliance may need to use more water than usual.
- Fully automatic and semi-automatic cleaning may not be available or may only be possible to a limited extent.
- It may not be possible to use the core temperature probe and the optional sous vide probe in certain cases.
- The only functions available will be those not affected by the fault, error, or malfunction that has occurred.

Cooking programs that can be used in emergency mode

The following table lists the errors after which the appliance can still be used in emergency mode if the error cannot be fixed right away.

Error No.					Limitations / Procedure
E01.x	-	-	Up to 284 °F		<ul style="list-style-type: none"> ▪ No boiler pre-heating ▪ Cleaning will not be possible
E02	x	Up to 284 °F	Up to 284 °F	Up to 284 °F	<ul style="list-style-type: none"> ▪ Let the appliance cool down ▪ Finish cooking the product at a lower cooking temperature and with a longer cooking time ▪ Cleaning will not be possible
E03.x	At 212 °F	-	-	-	<ul style="list-style-type: none"> ▪ Longer cooking time ▪ Uneven cooking results are possible (the food in the upper racks will be ready first)
E21.1	At 212 °F	-	-	-	<ul style="list-style-type: none"> ▪ Longer cooking time ▪ Uneven cooking results are possible ▪ Cleaning will not be possible

Error No.					Limitations / Procedure
E21.3	At 212 °F	-	-	-	Cleaning will not be possible
E22.x	x	x	x	x	The core temperature probe or sous vide probe will not work
E23.1 E23.3	-	-	x	-	<ul style="list-style-type: none"> ▪ No boiler pre-heating ▪ Cleaning will not be possible
E24.1 E24.3	At 212 °F	-	x	-	Cleaning will not be possible
E25.1 E25.3	-	-	Up to 284 °F	-	<ul style="list-style-type: none"> ▪ Increased water consumption due to continuous collector cooling ▪ Cleaning will not be possible
E26.1 E26.3	-	-	x	-	<ul style="list-style-type: none"> ▪ No boiler pre-heating ▪ Cleaning will not be possible
E28.1.1 E28.1.3	At 212 °F	-	-	-	Cleaning will not be possible
E28.2.1 E28.2.3	-	-	x	-	Cleaning will not be possible
E30.x	x	x	x	x	Only affects cleaning
E33.0	-	-	x	-	No boiler pre-heating
E34.0	x	x	x	x	<ul style="list-style-type: none"> ▪ No boiler rinsing ▪ Affects cleaning
E35.0	x	x	x	x	Affects cleaning and Crisp&Tasty
E58.0					
E59.0					
E60.0	x	x	x	x	Only affects cleaning
E61.0					
E62.0					
E63.0	-	-	x	-	<ul style="list-style-type: none"> ▪ No boiler pre-heating ▪ Cleaning will not be possible
E91.x	x	x	x	x	
E92.x	x	x	x	x	

- x Emergency mode available
- Emergency mode unavailable

6.2.3 Troubleshooting – Problems During Operation

Problems with the food being cooked

Problem	Possible cause	Required response
Irregular browning	The suction panel is not closed properly	<i>Release the suction panel and lock it back in place</i> on page 123
	The cooking compartment is not pre-heated	Pre-heat the cooking compartment
	The cooking compartment temperature is too high	Select a lower cooking temperature and cook the food longer
	The heating system is malfunctioning partially or entirely	Contact Customer Service

Problems with the appliance

Problem	Possible cause	Required response
The appliance does not respond to input for 10 – 20 seconds	Program crash	Press and hold the ON/OFF button for five seconds or disconnect the appliance from the outlet for five seconds
The appliance cannot be turned on or off anymore	The ON/OFF button is locked for three seconds	Try again after three seconds.
Water is coming out from under the appliance when the appliance door is closed	Regardless of the cause	Caution! Contamination hazard Destroy all food that has been in contact with the water.
	The drain pipe or wastewater system is clogged or constricted	<ul style="list-style-type: none"> ▪ Check the drain pipe and the on-site wastewater system and clean if necessary ▪ Use a funnel waste trap if necessary
	Non-detachable drain connection in appliances with fully automatic, automatic, or semi-automatic oven cleaning	
	The exhaust vent is clogged or covered	Remove the object clogging or covering it
	The appliance drain is clogged	Clean the appliance drain
In EB models: Water is sprayed into the cooking compartment during operation	In EB models: The automatic boiler rinsing system has not been run on a daily basis	In EB models: Empty and rinse out the boiler
There is water inside the cooking compartment	The cooking compartment drain is clogged	Flush the cooking compartment drain

Problems during cleaning

Problem	Possible cause	Required response
Black spots inside the cooking compartment	Wrong cleaning agent	<ul style="list-style-type: none"> ▪ Use ConvoClean forte for fully automatic oven cleaning with canisters ▪ Use ConvoClean forte S for fully automatic oven cleaning with single-measure dispensing ▪ Use ConvoClean forte or ConvoClean new for semi-automatic oven cleaning
	The water is too hard	Adjust the water hardness; see ' <i>Technical Data</i> ' in the installation manual
Poor cleaning results	The wrong soiling level has been set	Select a higher cleaning level
	The wrong cleaning agent was used	<ul style="list-style-type: none"> ▪ Use ConvoClean forte or ConvoClean new for fully automatic oven cleaning with canisters ▪ Use ConvoClean forte S or ConvoClean new S for fully automatic oven cleaning with single-measure dispensing ▪ Use ConvoClean forte or ConvoClean new for semi-automatic oven cleaning

6.3 Maintenance work

Contents

This section covers the following subjects:

	Page
Working Safely When Performing Maintenance	139
Replacing the hygienic plug-in gasket	140
Replacing the oven light halogen lamp	141



6.3.1 Working Safely When Performing Maintenance

For your and your employees' safety

Every person (user) must read and understand the contents in the “*For Your Safety* on page 21” section before they work with or on the combi steamer for the first time. In addition, every user must follow the instructions and warnings in said section at all times.

As the combi steamer's owner, or as the owner's employee responsible for the staff who will be using the combi steamer, set the necessary rules and brief all new employees.

Every user must read and understand the safe work rules specified in this section before starting any work and follow them without exception.

Every user must read and understand the risks and hazards described in this section and in the following instructions before starting any work and follow the corresponding safety instructions without exception.

Personal protective equipment for all users

As a user, you must wear the personal protective equipment specified for your work in the “*Personal Protective Equipment* on page 46” section of “*For Your Safety*.”

Electrical power components

⚠ WARNING

Risk of electric shock posed by live parts

Touching live parts underneath the cover or underneath the control panel may result in electric shock.

- ▷ Make sure that the cover and the control panel are properly installed.
- ▷ Make sure that all maintenance work under the covers, under the control panel, and on the power cable is performed exclusively by a qualified electrician from an authorized service company.

Hot surfaces

⚠ WARNING

Risk of burns posed by high temperatures on the appliance's interior and exterior parts.

Touching any interior cooking compartment parts, the inside of the appliance door, or any parts that are or were found inside the cooking compartment during cooking may result in burns. Touching the exhaust vent and exhaust outlet may also result in burns.

- ▷ Before performing any maintenance work, wait until the cooking compartment has cooled down to a temperature lower than 140 °F or cool it down with the “Cool down” function.
- ▷ Wear the required personal protective equipment.

Sheet metal parts with sharp edges

⚠ WARNING

Cut hazard posed by sheet metal parts with sharp edges

Working with or behind sheet metal parts with sharp edges poses a cut hazard for hands.

- ▷ Exercise caution.
- ▷ Wear the required personal protective equipment.

6.3.2 Replacing the hygienic plug-in gasket

⚠ For your safety when performing maintenance

Before starting any maintenance work, familiarize yourself with the rules, risks, and hazards specified in “*Working Safely When Performing Maintenance* on page 139” and follow all the corresponding instructions without exception.

Procedures that you must be familiar with

You will need to be familiar with the following steps:

- Safely Opening and Closing the Appliance Door 68
- Removing and Installing the Hygienic Plug-In Gasket 126

Spare parts included

As indicated in the spare parts list, the required spare part is:

- One (1) hygienic plug-in gasket

Prerequisites

Check whether the following prerequisites are met:

- The combi steamer must have cooled down to a temperature of less than 140 °F since the last time it was used.
- The appliance door must be open.
- The new gasket has been inspected for damage and is not damaged.

Replacing the hygienic plug-in gasket

To remove the old hygienic plug-in gasket and install the new one, follow the steps described in “*Removing and Installing the Hygienic Plug-In Gasket* on page 126.”

6.3.3 Replacing the oven light halogen lamp

⚠ For your safety when performing maintenance

Before starting any maintenance work, familiarize yourself with the rules, risks, and hazards specified in “*Working Safely When Performing Maintenance* on page 139” and follow all the corresponding instructions without exception.

Procedures that you must be familiar with

You will need to be familiar with the following steps:

- Safely Opening and Closing the Appliance Door 68
- Removing and Installing the Racks 83
- Using the Transport Trolley to Put Food Inside the Cooking Compartment and Take It Out 76

Spare parts included

As indicated in the spare parts list, the required spare part is:

- One (1) 12 V halogen lamp

Required tools

You will need the following tools:

- Socket wrench with a width across flats of 8 mm

Handling the halogen lamp

Always wear clean gloves when grabbing halogen lamps (alternatively, you can use a cloth). Do not touch the bulb in new halogen lamps, or halogen lamps that you will be reusing, with your bare fingers.

If the halogen lamp cannot be removed completely, e.g., the terminals are stuck, contact a service technician immediately.

Prerequisites

Check whether the following prerequisites are met:

- The combi steamer has been de-energized and locked and tagged out.
- The cooking compartment must have cooled down to a temperature of less than 140 °F since the last time it was used.
- **On table-top models with racks:** The right-hand side rack has been swung towards the inside of the cooking compartment.
- **On table-top models with a mobile shelf rack:** The mobile shelf rack and the roll-in frame must have been taken out from the cooking compartment.
- The halogen lamp has already cooled down.
- The new halogen lamp has been inspected for damage and is not damaged.

Removing the halogen lamp

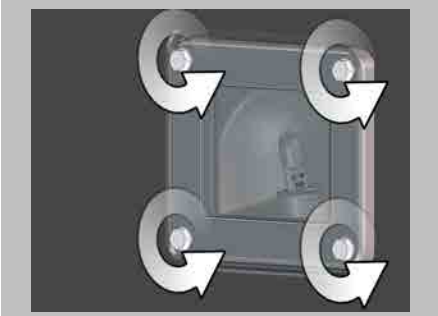
- 

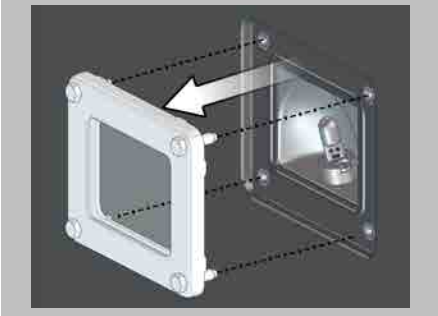
Remove the four oven light hex screws using the socket wrench. Due to its design, the assembly consisting of the screws, bezel, glass pane, seal, and bracket will remain together when the screws are unscrewed.
- 

Remove the entire assembly from the cooking compartment wall.
- 

Reach into the reflector housing through the opening on the cooking compartment wall and pull out the halogen lamp upwards in a straight line.

Installing the halogen lamp

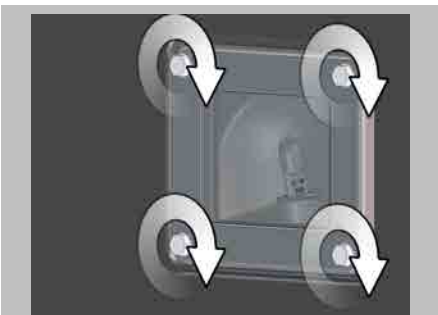
- 

Follow the same steps used to remove the halogen lamp, but in opposite order. Once you are done, remove all objects from the cooking compartment. Then rinse or wipe the cooking compartment clean.

Combi Steamer Convotherm 4 Table-Top Models

Serial No.

Item no.

Order No.

Manitowoc Foodservice is a global company dedicated to bringing value to foodservice operators by equipping them with highly individualized real-world answers that enhance menus, service, profits, and efficiency.

To learn how Manitowoc Foodservice and its leading brands can equip you, visit our global web site at www.manitowocfoodservice.com then find the regional or local resources available to you.

