

COOKING EQUIPMENT
CHARBROILER RANGE



HOBART UK,
 SOUTHGATE WAY,
 ORTON SOUTHGATE,
 PETERBOROUGH.
 PE2 6GN
 0844 888 7777
 www.hobartuk.com

Charbroiler Range - LPG Gas

BCB600-2

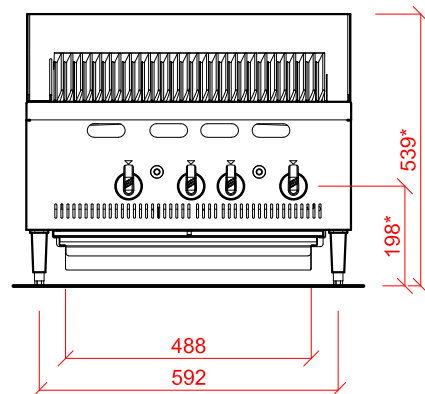
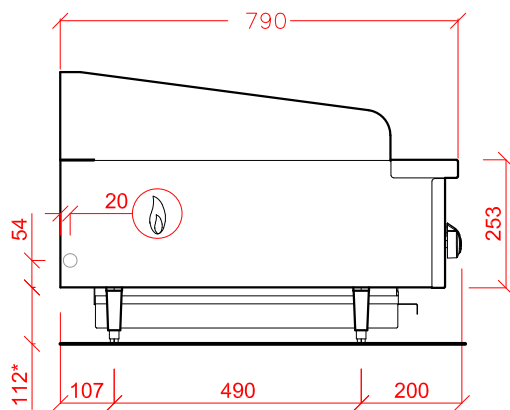
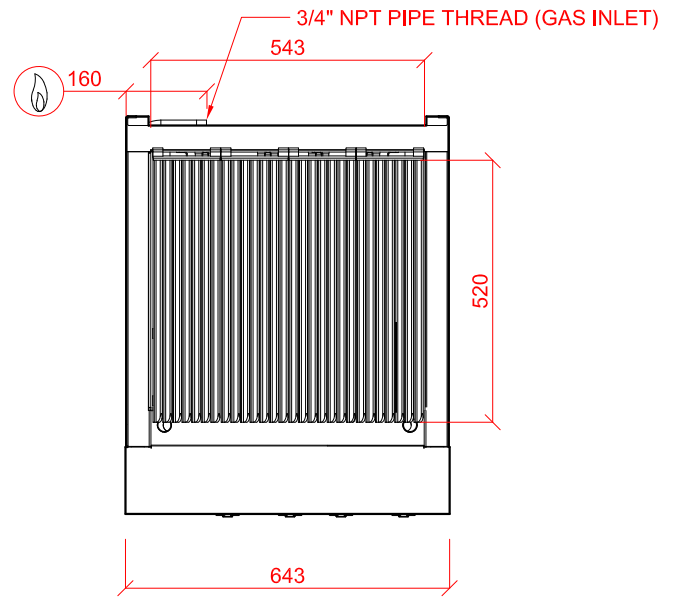

Device Number

Description

Gas

Notes

BCB600-2

GAS CHARBROILER
 - (LPG Gas).
 (WITH PIEZO IGNITION).

14.0kW /
 (47,780BTU/H)

22mm CONNECTION, 37m BAR

SPECIAL NOTE:
 INSTALLATION MUST COMPLY
 WITH CURRENT GAS SAFETY
 REGULATIONS AND BS 6173
 UNIT WEIGHT - 86kg