

WAREWASHING



Glass and dishwashers ECOMAX

G404

G504

F504

Installation and Operation Manual

*(Translation of the original operating
instructions)*

EN



OPERATING INSTRUCTIONS NOVEMBER 2017

START UP

1. Ensure the mains power is on
2. Check the chemical levels
3. Check water softener- top up salt as necessary (S models)
4. Check that the filters & strainer are in position
5. Switch on the power at the power button

TANK FILLING and WATER HEATING

1. The tank will fill with water and the GREEN light next to the power button will flash continuously whilst the tank fills up and the water is heated
2. When the GREEN light stops flashing the machine is ready to use

LOADING DISHWASHER

1. With the door open, slide the loaded basket from the entrance into the dishwasher
2. Close the door

PROGRAM SELECTION

1. Press programme button 1 or 2 for the desired wash cycle, 1 being the fastest
2. The adjacent GREEN light will move from permanently lit to continuously flashing whilst the cycle is in progress

UNLOADING

1. The GREEN programme light changes to permanently lit- the wash cycle has completed
2. Open the door
3. Slide the basket to the exit position on the door & leave to air dry
4. If the dishwasher is not going to be used straightaway, close the door to retain the heat in the water

DRAIN DOWN and CLEANING

1. Press and hold the drain button for about 3 seconds. The GREEN light will come on when the drain down programme has been activated
2. Once drained down is completed, the GREEN light will go off and the machine automatically powers off
3. Proceed with the daily cleaning procedures

SALT REPLENISHMENT

1. Remove the screw cap located in the back right section of the wash chamber and using the funnel provided fill up with salt (any spillage to be wiped away)
2. PLEASE NOTE when the machine is running during a regeneration cycle the small light will flash on the control panel. There is nothing to do, just wait for the cycle to finish. This particular wash cycle will be extended by approximately 3-5 minutes

PRIMING THE CHEMICALS

1. The machine must be turned on from the isolator however switched off at the control panel
2. Open the door
3. Hold buttons 1 & 2 together until they both light up
4. Close door
5. Press button 1 (4 times) and scroll through to number 05 (detergent priming)
6. Press button 2. 1 will display directly beneath 05
7. Press the drain button once and the detergent chemical will prime automatically
8. The light will flash underneath number 05 and stop priming when the process is complete
9. Press button 1 once and 06 will display in the control panel (rinse aid priming)
10. Press button 2. 1 will display directly beneath 06
11. Press the drain button once and the rinse aid chemical will prime automatically
12. The light will flash underneath number 6 and stop when the process is complete
13. Open and close the door to restart the machine
14. Start-up the machine and run it through 2-3 cycles and the machine will be ready for use

Publisher

HOBART GmbH
Robert-Bosch-Str. 17
77656 Offenburg
Tel. +49(0)781 600 0
Fax +49(0)781 600 23 19
E-mail: info@hobart.de
Internet: www.hobart.de

Product disclaimer

Installations and repairs carried out by non-authorized technicians or using non-genuine spare parts, and any technical alterations to the machine not approved by the manufacturer will invalidate the manufacturer's warranty and product liability.

HOBART reserves the right to make changes or improvements to its products without prior notice.

© HOBART GmbH, Offenburg 2017

Table of Contents

1	Notes on the documentation	5
1.1	Application	5
1.2	Layout of the documentation	5
1.3	Representation convention	5
2	Safety instructions and regulations	7
2.1	Safety instructions and warning notices	7
2.2	Basic safety instructions	7
2.3	Property damage	9
3	Product description	10
3.1	Intended purpose	10
3.2	Designation	10
3.3	Technical specifications	10
3.4	Conformity	11
4	Controls	12
5	Installation	13
5.1	Personnel qualification	13
5.2	Special safety instructions	13
5.3	Transporting to the installation location	14
5.4	Removing the packaging	14
5.5	Installing the machine	14
5.6	Connecting to the power supply	14
5.7	Connecting the water	15
5.8	Connecting the drain	16
6	Commissioning	17
6.1	Personnel qualification	17
6.2	Setting the water hardness (optional)	17
6.3	Filling the salt reservoir (optional)	17
6.4	Filling chemical hoses	18
6.5	Tank	19
7	Operation	20
7.1	Personnel qualification	20
7.2	Special safety instructions	20
7.3	Notes for optimum washing result	20
7.4	Preparations for washing	21
7.5	Washing	22
7.6	Switch off machine	23

Table of Contents

7.7	Executing daily cleaning	23
7.8	Executing weekly cleaning	24
8	Settings	25
8.1	Overview of operator menu	25
8.2	Opening the operator menu	25
8.3	Detergent/dosage amount	26
8.4	Rinse aid/dosage amount	26
8.5	Setting the water hardness (optional)	26
8.6	Wash cycles	27
8.7	Hose filling detergent	28
8.8	Hose filling rinse aid	28
8.9	External water treatment	29
9	Display of faults and information	33
9.1	Error	33
9.2	Information	34
10	Troubleshooting guide	35
10.1	Poor wash result	35
10.2	Other faults	36
10.3	Malfunctions	36
11	Maintenance	37
12	Disposal	38

1 Notes on the documentation

1.1 Application

This document contains the most important information for the installation and commissioning of the machine by qualified personnel, as well as the information required for day-to-day operation by the operator.

- ▶ Keep the operating instructions and all referenced documents in a safe and accessible place.
- ▶ If you sell the machine, pass on the installation and operating instructions.

1.2 Layout of the documentation

Referenced documents are all instructions that describe the installation, operation, maintenance and repair of the device, as well as additional instructions for all accessories used.

For the operator:





- Operating instructions

For the specialised tradesman:





- Installation instructions
- Circuit diagram
- Spare Parts Catalogue

1.3 Representation convention

1.3.1 Symbols used

Symbol	Meaning
	Warning of hazardous electrical voltage
	Beware of explosion
	Warning of risk of crushing
	Beware of hazardous substances

Notes on the documentation

Symbol	Meaning
	Beware of hand injuries
	Beware of slipping
	Beware of hazard area
	Useful additional information and tips

1.3.2 Representation in the text

Representation	Meaning
NOTE	Important information on machine operation, not a warning notice
▶	Step
↳	Outcome/result
–	Listing 1st level
•	Listing 2nd level





2 Safety instructions and regulations

2.1 Safety instructions and warning notices

- ▶ During machine operation, observe the general safety instructions and warning notices that precede each action.

2.1.1 Hazard levels

The hazard level is part of the safety instructions and is denoted by the signal word. Potential consequences are differentiated by the choice of signal word.

 DANGER	imminent danger: results in serious physical injury or death
 WARNING	potentially hazardous situation: can cause serious physical injury or death
 CAUTION	potentially hazardous situation: can cause minor physical injury
 NOTICE	potentially harmful situation: can cause damage to the product or other objects

2.1.2 Layout of warning notices

Warning notices are depicted with warning symbols and signal word in the corresponding safety colours.



CAUTION

Nature and source of the hazard

Explanation on the nature and source of the hazard

- ▶ Measures for averting the hazard
- ▶ additional measures for averting the hazard, where applicable

2.2 Basic safety instructions

2.2.1 Product safety

The machine conforms to state-of-the-art technology and the recognised safety regulations. Nonetheless, hazards may occur.

Operate the machine only if it is in perfect working order, and in compliance with the operating instructions.

Safety instructions and regulations

All modifications and alterations to the product are reserved for persons authorised by HOBART. Configuration is password-protected.

2.2.2 Personnel qualification

- ▶ Observe the regulations on occupational health and safety.
- ▶ Carefully read through the operation manual before use.

Activity	User group	Qualification/training
Installation/Commissioning	Qualified personnel	Authorised electrician (qualified electrician or persons who have undergone equivalent training)
	Trainees	Only under appropriate supervision and inspection
Work on the electrical system	Qualified personnel	Qualified electrician
Operation	Laymen/disabled persons	Training by the operator using the operation manual, hazard briefing
	Children from 14 years old	Training by the operator using the operation manual, hazard briefing, only under supervision
	Children from 13 years old	not permitted
Maintenance, repair	Qualified personnel	Hobart Service, or by Hobart-trained service technicians
	Trainees	Only under appropriate supervision and inspection

2.2.3 Product-specific hazards

Avoid body parts being crushed or knocked:

- ▶ Observe the instructions on the packaging for storage, lifting or transporting.

Avoid risk of explosion:

- ▶ Do not install machine in a potentially-explosive location.

Avoid electric shock, fire risk:

- ▶ Do not allow water to flow under live components.
 - Make sure the machine is correctly stored (see frost damage section 2.3).
 - Make sure that the machine does not overflow when being filled.
- ▶ Do not damage the connection cable while unpacking.
- ▶ Have the machine connected to the power supply by qualified personnel.
- ▶ Have all modifications to the machine carried out by qualified personnel.
- ▶ Have additional feed tanks mounted by qualified personnel.
- ▶ Do not operate the machine unsupervised.

Safety instructions and regulations

Avoid chemical burns, sensitisation of the skin, poisoning:

- ▶ Wear protective equipment (gloves, safety goggles, protective clothing) when handling chemicals.
- ▶ Use only suitable chemicals. Observe the manufacturer`s data.
- ▶ Have chemical sensor system set by authorised trained service technicians.
- ▶ Do not open the machine during operation, wait for the program to finish.
- ▶ Disconnect the machine from the mains prior to cleaning.
- ▶ For cleaning, wear protective equipment (gloves, safety goggles, protective clothing) when touching parts contaminated by detergent.

Avoid burns, scalds (to the hands):

- ▶ Do not open the machine during operation or the evaporation phase, wait for the programme to finish.
Otherwise, hot water could spray out.
- ▶ Disconnect the machine from the mains prior to cleaning.

Avoid slipping:

- ✓ Moisture can build up on the machine floor.
- ▶ Provide a floor covering that is guaranteed to be non-slip in case of moisture.

Residues on the washware, hygiene regulations not maintained.

- ▶ Hygiene regulations must be maintained and/or demonstrated in accordance with the national provisions.

2.2.4 Additional hazards

Potential hazards caused by operating resources to be used can be found in the enclosed safety datasheets. Workplaces must be signed accordingly.

2.3 Property damage

Avoid frost damage:

- ✓ Temperatures below 0°C lead to functional damage.
- ▶ Before storing below 0°C, empty residual water in hoses, tank and boiler.
- ▶ Prior to restart, store the machine at room temperature (min. 15°C) for 24h.

Avoid water damage:

- ▶ Do not operate the machine without supervision.
- ▶ Close on-site shut-off valves at the end of operation.

Product description

3 Product description

3.1 Intended purpose

The machine is an item of technical equipment intended solely for commercial dishwashing.

The machine is designed solely for cleaning crockery (porcelain, glass, ceramic, temperature-resistant plastics or stainless steel or similar) from the food industry.

Not for washing:

- Containers that do not come into contact with foodstuffs, such as ashtrays, candlesticks, electric appliances etc.
- Animals or textiles
- Foodstuffs intended for further consumption

3.2 Designation

The rating plate is located on the front of the machine. If you have any questions regarding service and parts, quote the serial and DSN No.

3.3 Technical specifications

Dimensions (H x W x D)	820 x 576 x 607 mm (G404: 700 x 436 x 539)
Water consumption per rinse cycle	2.3 l (G404: 2 l)
Cold or hot water connection	max. 60°C
Voltage	see rating plate
Total connected load	
Fuse protection	
Tank capacity	25 l (G404: 10 l)
Loading height	360 mm (G404: 308 mm)
Emission sound pressure level L_{pA} (Measurement uncertainty $k_{pA} = 2.5$ dB)	56 dB (A) for undercounter machine (G404: 60 dB (A))
Weight	46 kg (G404: 30 kg)

3.4 Conformity



Original

Konformitätserklärung

Declaration of Conformity / Déclaration de Conformité / Declaración de Conformidad / Dichiarazione di conformità / Conformiteitsverklaring / Deklaracja zgodności / Декларация соответствия / Uygunluk beyanı / Deklaracija o skladnosti / Izjava o skladnosti / Declaração de Conformidade / Prohlášení o shodě

Hersteller / Dokumentationsbevollmächtigter:

Manufacturer / authorized to compile the technical file:
Fabricant / autorisé à constituer le dossier technique:
Fabricante / autorizado para unificar la información técnica:
Fabbricante / Responsabile della documentazione:
Fabrikant / Geautoriseerd om de technische documentatie samen te stellen:
Producent / autoryzowany przedstawić:
Изготовитель / ответственный за составление документации:
Üretici / Dokümantasyon yetkilisi:
Proizvođač / ovlašten za sastavljanje tehničkog spisa:
Proizvajalec / pooblaščen za dokumentacijo:
Fabricante / Responsável pela documentação:
Výrobce / osoba zplnomocněná sestavením dokumentace:

HOBART GMBH / Ruediger Nuebling
Robert-Bosch-Straße 17
77656 Offenburg / Germany

Maschine:	Geschirrspülmaschine (F504)	Gläserpülmaschine (G404/G504)
Machine:	Dishwasher	Glasswasher
Machine:	Machine à laver la vaisselle	Lave verres
Máquina:	Lavavajillas	Lavavasos
Maschina:	Lavastoviglie	Lavabicchieri
Machine:	Vaatwasmachine	Glazenwasmachine
Urządzenie:	Zmywarka do naczyń	Zmywarka do naczyń ze szkła
Машина:	Посудомоечная машина	Станомоечная машина
Makine:	Tezgahalt buluşık makineleri	Bardak yıkama
Stroj:	Perilica posuda	Perilica čaša
Stroj:	Stroj za pomivanje posode	Stroj za pomivanje kozarcev
Máquina:	Máquina lava-loiça	Máquina lava-copos
Stroj:	Myčka na nádobí	Myčka na sklenice

Marke: HOBART

Trade mark/ Marque/
Marca comercial/ Marchio/ Merk/
Marka/ Марка/ Marka/ Zaštitni
znak/ Znamka / Marca/ Značka

Type:	Ecomax F504 - Serie	Cookmax F504 - Serie	Design State: FG-16-01	Serial No.: 86 71 XXXXX
	Ecomax G504 - Serie	FHE F504 - Serie		
	Ecomax G404 - Serie	FHE G404 - Serie		
	Cookmax G404 - Serie			

Hiermit bestätigen wir, dass die genannte Maschine entsprechend den nachfolgend aufgeführten Normen gefertigt und geprüft worden ist.

Par la présente, nous déclarons que la machine citée ci-dessus a été fabriquée et testée en conformité aux normes.
Por la siguiente confirmamos que la máquina mencionada ha sido fabricada conforme a las siguientes normas.
Con la presente confermiamo che la macchina indicata è stata costruita in conformità alle norme di seguito riportate.
Hierbij bevestigen wij dat de genoemde machine is gefabriceerd en getest volgens de hiervolgende voorwaarden.
Niniejszym deklaramy, że wymieniony produkt spełnia wymogi następujących norm.
Настоящим мы подтверждаем, что указанная машина изготовлена в соответствии с приведенными ниже нормами.
İşbu belge ile belirtilen makinenin aşağıda listelenen normlar doğrultusunda hazırladığımız beyan ederiz.
Ovimе потврђујемо да је горе наведени stroj произведен и тестиран суkladно sljedecim standardima.
S tem izjavljamo, da je naveden stroj izdelan in preizkušen v skladu s spodaj navedenimi standardi.
Com a presente declaramos que a máquina supracitada foi construída e inspeccionada segundo as normas referidas a seguir.
Timto potvrzujeme, že uvedený stroj byl vyroben a zkontrolován podle následujících norem.

EN 60335-2-58:2005 + Corr. 2007 + A1:2008 + A11:2010 + A2:2015 + A12:2016
EN ISO 12100:2010
EN 55014-2:2015
EN 61000-6-2:2005
EN 55014-1:2006 + A1:2009 + A2:2011
EN 61000-6-3:2007 + A1:2011
DIN SPEC 10534:2012-08

Die Maschine stimmt mit den folgenden Richtlinien überein:

The product complies with the following directives:
La machine est conforme aux directives fixées:
La máquina armoniza con las siguientes Directivas:
La macchina è conforme alle direttive seguenti:
Het product voldoet aan de volgende richtlijnen:
Urządzenie spełnia wymogi następujących dyrektyw:
Машина соответствует требованиям следующих директив:
Makine, aşağıdaki yönetmelikler ile uyumludur:
Ovaj stroj je u skladu sa sljedecim direktivama:
Stroj ustreza zahtevam sledećih direktiv:
A máquina está em conformidade com as seguintes diretivas:
Stroj je v souladu s ustanovenými následujícími směrnice:

2006/42/EC (Maschinenrichtlinie, Machinery-Directive)
2014/30/EU (EMV-Richtlinie, EMC-Directive)

Die Schutzziele der Niederspannungsrichtlinie 2014/35/EU wurden gemäß Anhang I Nr. 1.5.1 der Maschinenrichtlinie 2006/42/EC eingehalten.

Protective Goals of the Low Voltage Directive 2014/35/EU are in compliance with Appendix I No 1.5.1 of the Machinery Directive 2006/42/EC.
Les objectifs de protection de la directive sur les basses tensions 2014/35/EU ont été respectés conforme à l'annexe I Nr. 1.5.1 der de la directive relative aux machines 2006/42/EC.
Directiva de protecciones de baja tensión 2014/35/EU estan en acuerdo con el apéndice I No 1.5.1. de la directiva de maquinaria 2006/42/EC.
Gli obiettivi di protezione della direttiva per basse tensioni 2014/35/EU è stata rispettata secondo allegato I n. 1.5.1 della Direttiva per macchine 2006/42/EC.
De veiligheidsdoelstellingen van de laagspanningsrichtlijn 2014/35/EU zijn nageleefd in overeenstemming met nr. 1.5.1 van bijlage I van de machine richtlijn 2006/42/EC.
Produkt spełnia wymogi bezpieczeństwa dyrektywy niskonapięciowej 2014/35/EU, zgodnie z załącznikiem I nr. 1.5.1 dyrektywy maszynowej 2006/42/EC.
Цели, охраняемые Директивой по высоковольтному оборудованию 2014/35/EU, соблюдены в соответствии с приложением № 1.5.1 Директивы по машинному оборудованию 2006/42/EC.
Alçak Gerilim Yönetmeliği 2014/35/EU'nin koruyucu hedeflerini, Makine Yönetmeliği 2006/42/EC, ek I no. 1.5.1'e göre uymulmuştur.
Sigurnosni ciljevi direktive o niskom naponu 2014/35/EU udovoljavaju dodatku i br. 1.5.1. Direktive o strojevima 2006/42/EC.
Uspoštevani so zaščitni cilji Direktive o nizki napetosti 2014/35/EU v skladu s prilogo I, št. 1.5.1 Direktive o strojih 2006/42/EC.
Os objetivos de proteção da Diretiva de Baixa Tensão 2014/35/EU foram cumpridos de acordo com o Apêndice I, n.º 1.5.1 da Diretiva de Máquinas 2006/42/EC.
Cile ochrany dle nízkonapěťové směrnice 2014/35/ES byly splněny dle přílohy I č. 1.5.1 směrnice o strojních zařízeních 2006/42/ES.

Bestätigt durch:

Confirmed by:

Offenburg, 16.02.2017

ppa.

Harald Disch
Direktor Produktentwicklung Europa
Director Warewash Engineering Europe

Controls

4 Controls

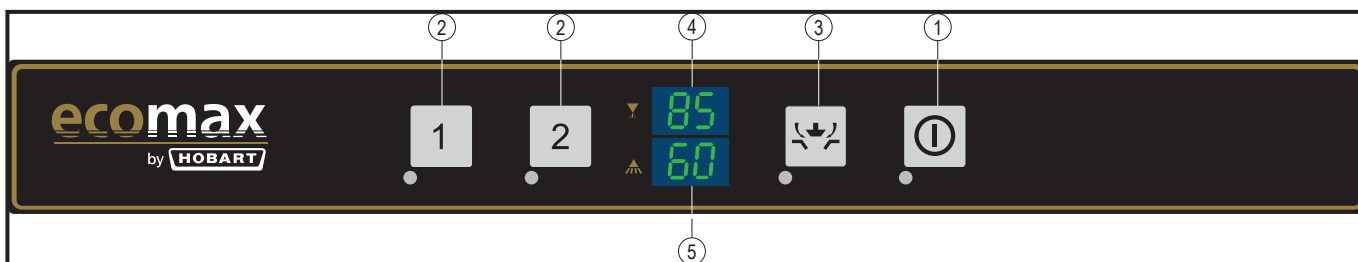

①	ON/Escape key	<p>Pressing this button switches the machine on.</p> <p>In case of operating error or faults, the machine can be switched off immediately without prior pump out by pressing this key.</p> <p>After switch off, however, the machine is not voltage free.</p>
②	Programme start keys	<p>Pressing these keys allows you to start the Short programme (1) or the Standard programme (2).</p>
③	OFF/Drain key	<p>Pressing and holding (3 seconds) this key activates the automatic self-cleaning cycle and then switches off the machine automatically. On machines with drain pump, the tank is emptied.</p> <p>After switch off, however, the machine is not voltage free.</p>
④	Temperature display, rinsing	
⑤	Temperature display, washing	

5 Installation

5.1 Personnel qualification

Installation must only be carried out by qualified personnel (see section 2.2.2).

5.2 Special safety instructions



WARNING

Risk of electric shock, fire hazard

Water (frost damage, machine overflow) flowing over live components can cause injury from electric shock or fire.

- ▶ Do not allow water to flow under live components.
- ▶ Make sure the machine is correctly stored (see frost damage section 2.3).
- ▶ Make sure that the machine does not overflow when being filled.



CAUTION

Risk of being crushed or knocked

When being lifted or transported, the machine can overturn or fall and cause injury.

- ▶ Observe the instructions on the packaging for storage, lifting or transporting.



WARNING

Risk of explosion

Installing the machine in a potentially explosive location can cause explosion and serious injury from ejected parts.

- ▶ Do not install machine in a potentially-explosive location.

NOTICE

Frost damage

Temperatures below 0°C during transport/storage cause function impairments.

- ▶ Prior to installation, store the machine at room temperature (min. 15°C) for 24h.

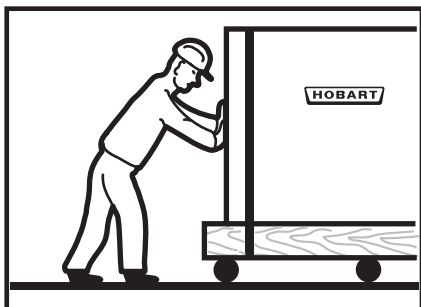

5.3 Transporting to the installation location

- ▶ Where possible transport packed on the pallet.
- ▶ Use suitable transport means (elevating truck, crane etc.).
- ▶ If using a forklift, shim the machine with wooden trusses.

5.4 Removing the packaging

CAUTION

Risk of electric shock, fire hazard

When the machine is unpacked, the connection cable can become damaged and cause injury from electric shock or fire.

- ▶ Do not damage the connection cable while unpacking the machine.
- ▶ Take cable measurement BGV A3.

- ▶ Remove packaging materials and accessories from the machine.
- ▶ Inspect the machine for possible transport damage.



5.5 Installing the machine

Wall clearance is not required.

- ▶ Align machine by turning the adjusting feet according to the spirit level.
- ▶ Distribute machine weight equally onto all feet.

NOTICE

Property damage

NOTE: Vapour may escape from the dishwasher door and damage the furniture.

- ▶ Adjacent furniture has to be protected to prevent swelling.

5.6 Connecting to the power supply

WARNING

Risk of electric shock

Failure to connect properly to the power supply can cause mortal danger from electric shock.

- ▶ Have the machine connected to the power supply only by qualified personnel.



NOTE: To guarantee the electrical safety of the machine, it must be connected to a protective earthing equipment conductor installed as specified. In addition, the machine must be connected on site to the equipotential bonding connection. The connecting screw (▽) provided for this purpose is located next to the cable inlet.

These fundamental safety requirements and the professional design of the on-site installation must be verified by a qualified electrician.

Hobart does not accept any liability for damage caused by improper installation! Any applicable local installation instructions must be observed!

The mains cable must be connected via a cut-out device (main switch or accessible plug device).

Modification to an alternative power supply is possible as per the variants on the circuit diagram. Connection diagrams are located adjacent to the connection terminals.

5.7 Connecting the water

NOTE: The machine must be operated with potable water. For water with an extremely high mineral content, an external demineralisation unit is recommended.

► If possible, connect to hot water (max. 60°C).

Water hardness:

- Machines without softener: max. 3 °d = 0.5 mmol/l.
- Machines with softener: max. 30 °d = 5.3 mmol/l.

Flow pressure:

- with integrated booster pump: flow pressure 0.8 – 6 bar.
- without integrated booster pump: flow pressure 2 - 6 bar.
- > 6 bar: provide pressure reducing valve.

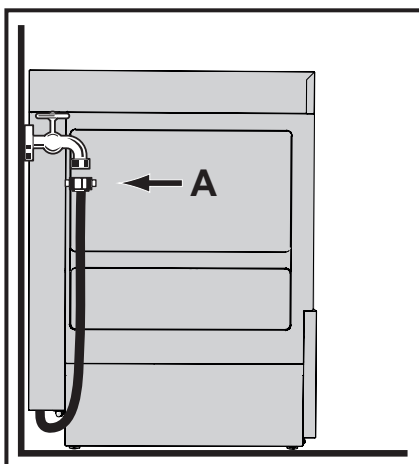

► Connect the union nut "A" (3/4" thread) of the water supply hose to the site shut off valve.

- Do not kink or cut the water supply hose.
- Any required extension must be executed using a suitable pressure hose.

5.8 Connecting the drain

Machine without drain pump:

- ▶ Ensure gravity drain.
- ▶ For these machine types, a floor drain is mandatory as the drain hose exits the machine at approx. 60 mm above floor level. Otherwise, residual water may remain in the tank and hose.

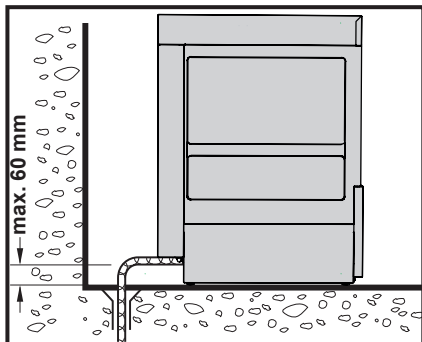

- ▶ Do not kink drain hose.

Machine with drain pump:

- ▶ The connection between machine and site drain must not exceed a max. height of 0.65 m.

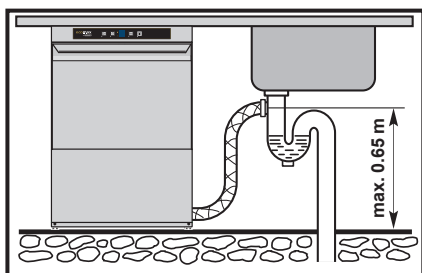

- ▶ Do not lay the drain hose loose on the ground (the hose could become frayed), but fasten it in-situ.
- ▶ Do not kink drain hose.

6 Commissioning

6.1 Personnel qualification

Commissioning must only be carried out by qualified personnel (see section 2.2.2).

6.2 Setting the water hardness (optional)

Machines with integrated softener have a water hardness setting.

NOTE: The softener must be set to the existing water hardness (ask at the local water works).

- ▶ Set hardness range according to section 8.5.

6.3 Filling the salt reservoir (optional)

NOTICE

Property damage

Accidentally filling the salt reservoir with detergent will damage the water softener.

- ▶ Do not fill the salt reservoir with detergent.



Unlike the regular salt fill, additional water has to be added during the commissioning procedure.

- ▶ Open the door.

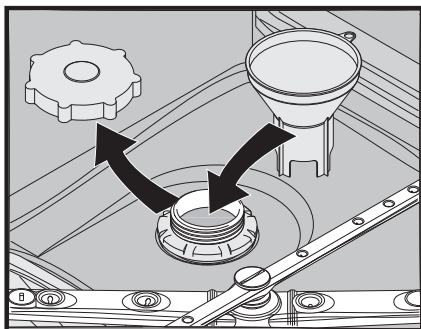

- ▶ Unscrew the salt reservoir lid and add ~1 kg of granular (2-8 mm) regenerating salt (do not use salt tablets).

- ▶ Fill up the reservoir with potable water (only at commissioning).
- ▶ Make sure the lid seal is free of dirt and salt.
- ▶ Screw lid back on and tighten.

NOTICE

Property damage

Salt residues on the tank floor cause corrosion damage.

- ▶ Remove salt residues by hand.
- ▶ On completion of the commissioning procedure, start a wash cycle to remove all traces of salt if necessary.



- ▶ If salt deficiency occurs during operation, the top display shows "SA", the bottom display shows "Lt".

- ▶ To pump out water in the tank, see section 7.6.
- ▶ Top up salt (see above). It then takes a few minutes until the display disappears.

6.4 Filling chemical hoses



We recommend the use of HOBART Hyline detergent and rinse aid.



CAUTION

Chemical burns, sensitisation of the skin, poisoning

The use of unsuitable chemicals can cause injury.

- ▶ Use only commercial detergent and rinse aid.
- ▶ Observe the manufacturer's application and safety instructions.



**! WARNING****Chemical burns, sensitisation of the skin, poisoning**

Filling the chemical container or chemical hoses with detergent or rinse aid for the first time incorrectly can cause serious injury.

- ▶ Wear protective equipment (gloves, safety goggles, protective clothing) when handling chemicals.

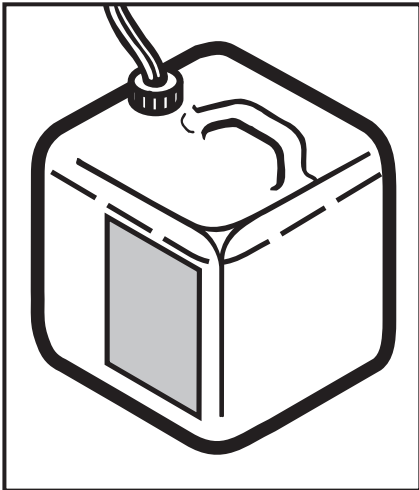

6.4.1 Provisioning external chemical canisters

Preparing the detergent:

- ✓ Suction height of dosing pump: max. 1.5 m.
- ▶ Place suction hose **without** colour marking at the suction valve at the bottom of the external reservoir.

Preparing the rinse aid:

- ✓ Suction height of dosing pump: max. 1.5 m.
- ▶ Place suction hose with **blue** marking at the suction valve at the bottom of the external reservoir.

6.5 Tank

In the case of machines without booster pump that are connected to cold water, we recommend filling and emptying the water tank once according to the instructions (see section [7.4.1](#) and [7.6](#)).

7 Operation

7.1 Personnel qualification

The machine must be operated by instructed personnel (see section 2.2.2).

7.2 Special safety instructions



CAUTION

Chemical burns, sensitisation of the skin, poisoning

If the Door is opened during operation, wash water can spurt out and cause injury.

- ▶ Do not open the Door during operation, wait for the program to finish.



WARNING

Slipping

Moisture can build up on the machine floor and cause slipping.

- ▶ Provide a floor covering that is guaranteed to be non-slip in case of moisture.

7.3 Notes for optimum washing result

The rinse result is significantly affected by the water quality. If the mineral content is high, the minerals dissolved become visible on the glasses in the form of spots and streaks during the drying process.



A HOBART trained service technician can determine the water's mineral content by measuring the electrical conductivity. Values of less than 80 $\mu\text{S}/\text{cm}$ are non-critical for rinsing glasses and cutlery. If the values are higher, we recommend the use of a HOBART HYDROLINE demineralization cartridge or a reverse osmosis unit.

If you have any questions, please contact your authorised HOBART service partner.



We recommend the use of special HOBART glass racks. HOBART racks hold the glasses in slightly inclined positions – this improves the rinse efficiency.

To avoid unpleasant smelling glasses, only chlorine-free detergent should be used for washing the glasses.

Before washing new glasses the first time with a commercial glass washer, intensive basic cleaning is mandatory to reduce the greasy film which is on most glasses for protection during production. We recommend this basic clean is carried out by hand (wear gloves) with a higher detergent concentration (minimum 10 g/l) in a sink using a brush.

7.4 Preparations for washing

7.4.1 Preparing the machine

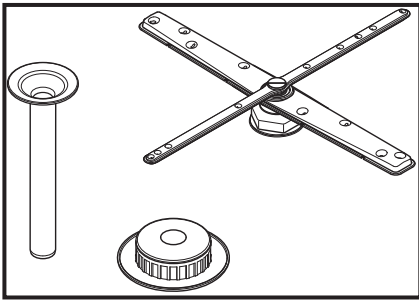

- ▶ Check correct position of wash/rinse arms, strainer, stand pipe and tank cover if fitted.

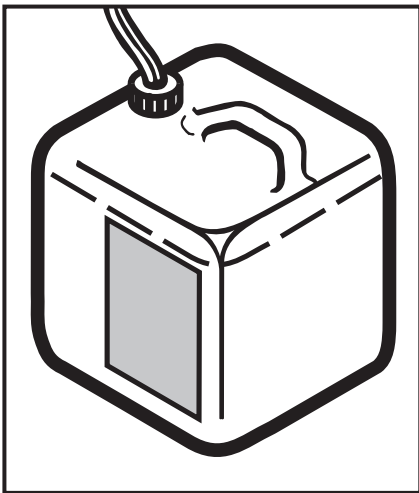

- ▶ Open site shut-off valve.
- ▶ Turn on main switch or insert the plug.
- ▶ Check level of detergent and rinse aid container.

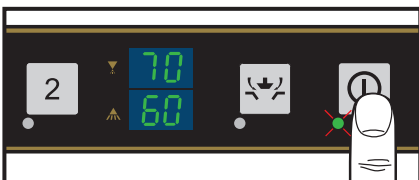

- ▶ Close Door.
- ▶ Press the ON/Escape key ①.

- ↳ During the filling and heating processes, the key LED flashes. This process can take several minutes.
- ↳ As soon as the LED is permanently lit, the machine is ready for operation.

7.4.2 Preparing the washware

- ▶ Remove large food scraps.
- ▶ Place washware face down in the rack.

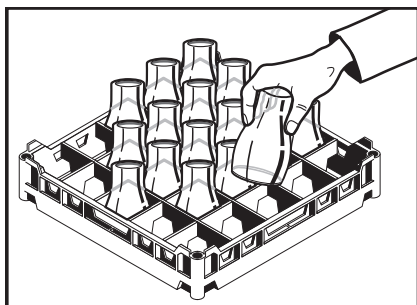

- ▶ Rinse off washware.

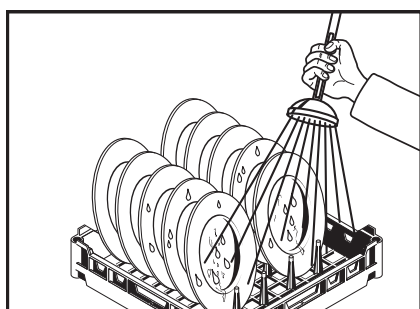

7.5 Washing

- ▶ Machines without dosing unit: Add detergent to the tank.
- ▶ Slide rack into the machine and close the door.

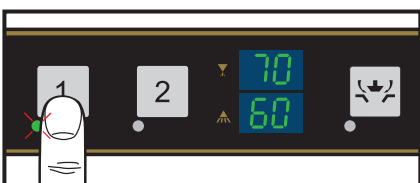
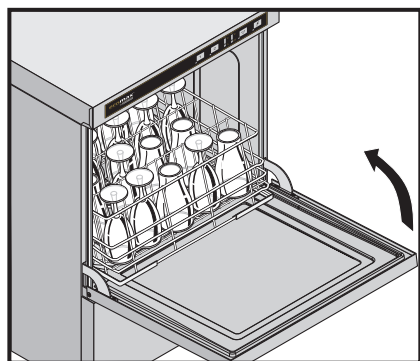

- ▶ Start either the Short or Standard programme.

Short programme = for slight dirt deposits

Standard programme = for normal dirt deposits

↳ While the program is running, the LED of the corresponding programme key flashes.

↳ As soon as the LED lights up permanently, the rinsing process is complete.

- ▶ Open the door and remove the rack.
- ▶ Allow the wash ware enough time to dry.

7.6 Switch off machine

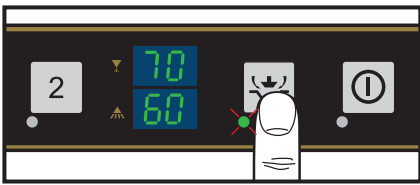
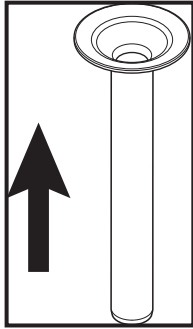

- ▶ Versions with stand pipe: Pull.

- ▶ Close Door.
- ▶ Press and hold the Drain key ③ (min. 3 seconds).

↳ During pump out, the Drain key LED flashes.



During pump out, the machine interior is cleaned automatically. On machines with drain pump, the tank is emptied. At the end of the program, the machine switches off automatically. Then remove any coarse food residues.

- ✓ When the machine has switched off:
 - ▶ Turn off main switch or remove the plug.
 - ▶ Close on-site shut-off valve.

7.7 Executing daily cleaning

NOTICE

Property damage

The use of unsuitable agents can cause corrosion damage.

- ▶ Do not use any chloric, acidic or metal-containing additives to clean the machine.
 - ▶ Do not use metal brushes.
-
- ▶ Open the door, remove strainer and standpipe if fitted. Rinse under running water. **Make sure that food debris does not enter pump intake!**



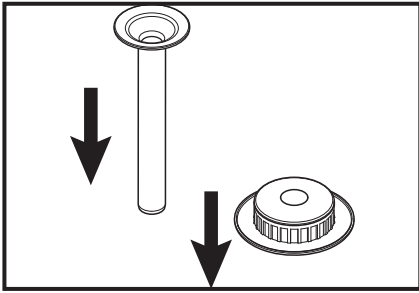

- ▶ Clean machine interior.
- ▶ Replace strainer and stand pipe if necessary.

- ▶ Leave the door open for ventilation.

7.8 Executing weekly cleaning

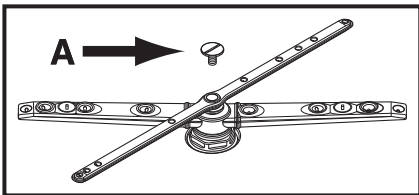

- ▶ Loosen the fastening screws (A) counter-clockwise.

- ▶ Removing and cleaning wash and rinse arms:
- ▶ Replace all parts.

8 Settings

8.1 Overview of operator menu

Submenu	Function
Detergent/dosage amount	Setting
Rinse aid/dosage amount	Setting
Water hardness	Setting
Wash cycles	Display
Hose filling detergent	For commissioning and replacement of the canister.
Hose filling rinse aid	For commissioning and replacement of the canister.
External water treatment	Total capacity display Setting the total capacity Remaining capacity display Resetting the counter Activate/deactivate

8.2 Opening the operator menu

NOTE: Possible only when the machine is switched off.

- ▶ Open Door.
- ▶ Press the Short programme key (1) and the Standard programme key (2) at the same time.

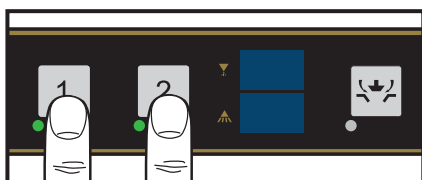

- ↳ The menu opens, key LEDs illuminate.
- ↳ The first submenu item "1" appears as soon as the door is closed.

If the menu is opened again, the display switches off and the entered settings are saved.

So the setting sequence described below can be interrupted at any time.

- ▶ Press the Short programme key (1) to scroll through the menus.

8.3 Detergent/dosage amount

Only relevant for integrated detergent/dosing units.

- ▶ Top display shows "01"
- ▶ The bottom display shows the current dosage value, default setting: 2.5 g/l

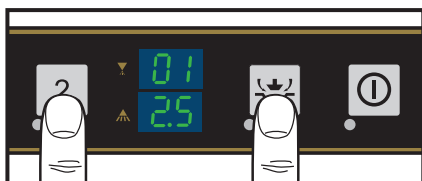

- ▶ To adjust the detergent/dosing quantity, increase using the Standard programme key (2) or reduce using the Drain key. The selected value (0-9.5 g/l) will be saved automatically.

- ▶ Make settings according to the recommendations of the detergent supplier.
- ▶ Open the door to escape and exit the menu.

8.4 Rinse aid/dosage amount

- ▶ Open menu (see section 8.2).
- ▶ Press the Short programme key (1) until the top display shows "02".
- ▶ The bottom display shows the current dosage value, default setting: 0.3 g/l.

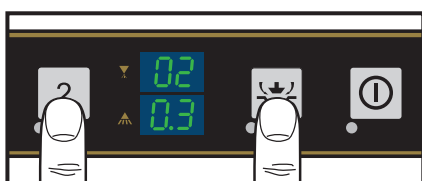
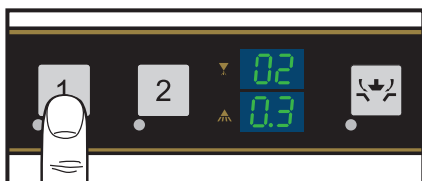

- ▶ To adjust the rinse aid/dosage quantity, increase using the Standard programme key (2) or reduce using the Drain key. The selected value (0-2 g/l) is automatically saved.

- ▶ Making settings according to the instructions of the rinse aid supplier.
- ▶ Open the door to escape and exit the menu.

8.5 Setting the water hardness (optional)

Only relevant with integrated softener.

NOTE: The softener must be set to the existing water hardness (ask at the local water works).

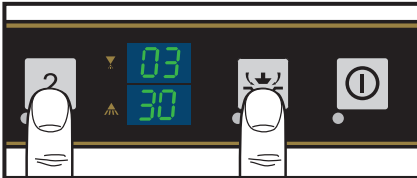
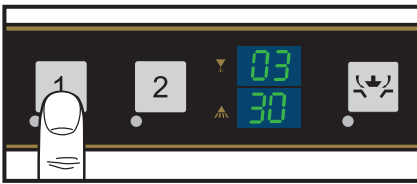

- ▶ Open menu (see section 8.2).
- ▶ Press the Short programme key (1) until the top display shows "03".
- ▶ The bottom display indicates the set degree of hardness in °d.
- ▶ To adjust the degree of hardness, increase using the Standard programme key (2) or reduce using the Drain key. The selected value (1-30) is automatically saved.

- ▶ Open the door to escape and exit the menu.

8.6 Wash cycles

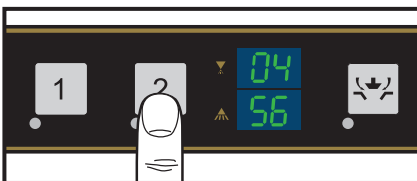
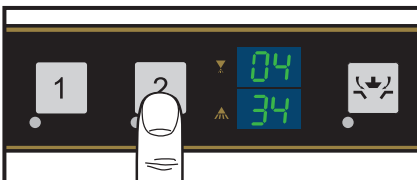
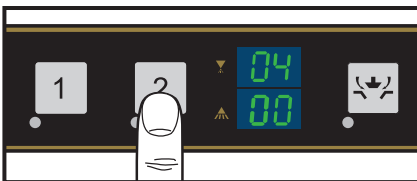

- ▶ Open menu (see section 8.2).
- ▶ Press the Short programme key (1) until the top display shows "04".
- ▶ Due to the bottom display being limited to 2 places, the value (max. 6 places) is shown as follows:
e.g. for wash programmes 003456.
- ▶ Pressing the Standard programme key (2) displays the first two places.
- ▶ The next two places are shown when the Standard programme key (2) is pressed.
- ▶ The last two places are shown when the PROGRAMME key is pressed.
- ▶ If the key is pressed once again this then shows the first display, etc.
- ▶ Open the door to escape and exit the menu.

8.7 Hose filling detergent

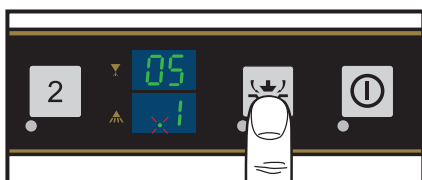
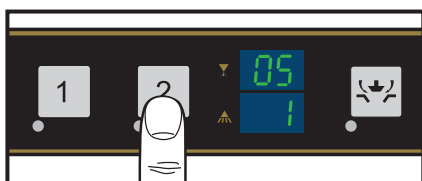
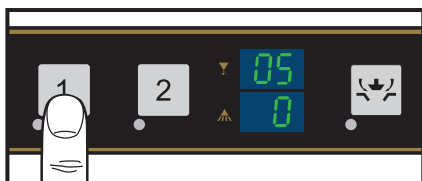

- ▶ Open menu (see section 8.2).
- ▶ Press the Short programme key (1) until the top display shows "05".

↳ Bottom display shows "0".

- ▶ Using the Standard programme key (2) to set the bottom display to "1".

- ▶ Press the Drain key.

↳ Hose filling starts for approx. 60 seconds.

↳ Item in bottom display flashes.

- ▶ Filling is completed when the flashing stops.
- ▶ Open the door to escape and exit the menu.

There is no need to wait until the end once the filling process has been activated. The filling of the rinse aid hose can also start in parallel.

8.8 Hose filling rinse aid

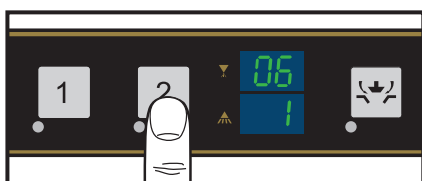
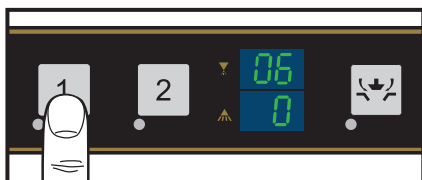

- ▶ Open the Settings menu (see section 8.2).
- ▶ Press the Short programme key (1) until the top display shows "06".

↳ Bottom display shows "0".

- ▶ Using the Standard programme key (2) to set the bottom display to "1".

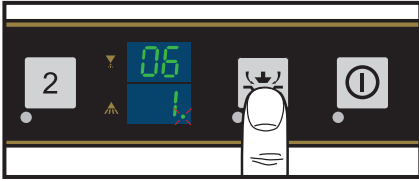

- ▶ Press the Drain key.

- ↳ Hose filling starts for approx. 120 seconds.
- ↳ Item in bottom display flashes.

- ▶ Filling is completed when the flashing stops.
- ▶ Open the door to escape and exit the menu.

8.9 External water treatment

Relevant only when activated (see section [8.9.5](#))

When using external water treatment (e.g. demineralisation cartridge or reverse osmosis), the capacity in litres (default setting 14000) can be monitored.

8.9.1 Total capacity display

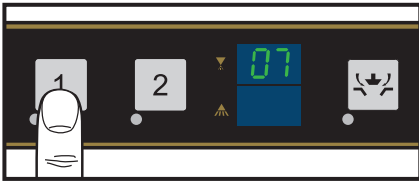

- ▶ Open menu (see section [8.2](#)).
- ▶ Press the Short programme key (1) until the top display shows "07".

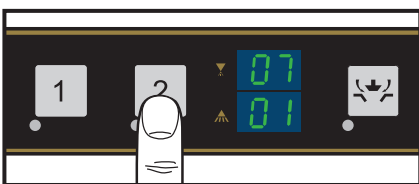

- ▶ Due to the bottom display being limited to 2 places, the value (max. 6 places) is shown as follows:
- ▶ Pressing the Standard programme key (2) displays the first two places.

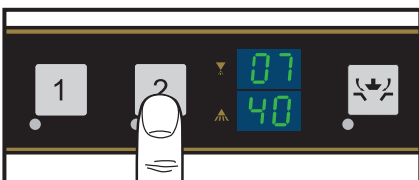

- ▶ The next two places are shown when the Standard programme key (2) is pressed.

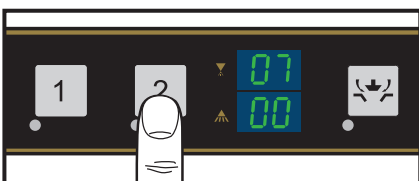

- ▶ The last two places are shown by pressing the Standard programme key (2).

- ▶ If the key is pressed once again this then shows the first display, etc.
- ▶ Open the door to escape and exit the menu.

8.9.2 Setting the total capacity

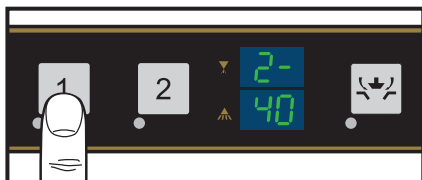
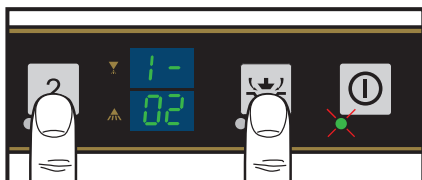
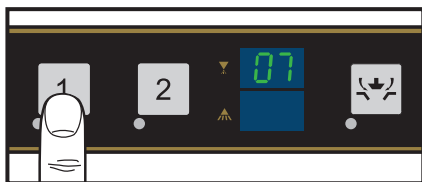

- ▶ Open menu (see section 8.2).
- ▶ Press the Short programme key (1) until the top display shows "07".

- ▶ Due to the bottom display being limited to 2 places, the value (max. 6 places) is shown as follows:
- ▶ The first two places are shown by pressing the ON/Escape key.

- ▶ To adjust the first two places, use the Standard programme key (2) to increase or the Drain key to reduce.

↳ The ON/Escape key LED flashes

- ▶ The next two places are shown when the Short programme key (1) is pressed.

- ▶ Set the first two places in the same way.
- ▶ The last two places are shown by pressing the Short programme key (1).

- ▶ Set the first two places in the same way.
- ▶ When the ON/Escape key is pressed for 3 sec. the entire value is saved.

↳ The ON/Escape key LED illuminates for 3 sec.

- ▶ The first display is shown again when the Short programme key (1) is re-pressed.
- ▶ Open the door to escape and exit the menu.

8.9.3 Residual water capacity display

The residual water capacity counts backwards from the set capacity value and can be showed as follows:



- ▶ Open menu (see section 8.2).
- ▶ Press the Short programme key (1) until the top display shows "08".

- ▶ Display and Settings of the value as section 8.9.1 + 8.9.2.

8.9.4 Resetting the residual water capacity

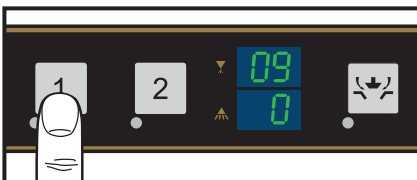

- ▶ Open menu (see section 8.2).
- ▶ Press the Short programme key (1) until the top display shows "09".

↳ Bottom display shows "0".



- ▶ Set the bottom display to "1" by pressing the Standard programme key (2).

↳ The ON/Escape key LED flashes.



- ▶ The total capacity is reset again by pressing the ON/Escape key for 3 sec.

↳ The ON/Escape key LED illuminates for 3 sec.

- ▶ Open the door to escape and exit the menu.

8.9.5 Activate/deactivate

This must be deactivated to use the capacity monitoring for external water treatment.

- ▶ Open menu (see section 8.2).

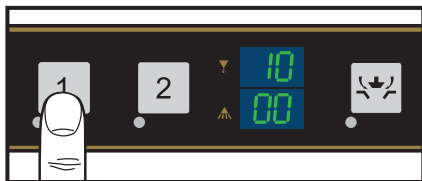

- ▶ Press the Short programme key (1) until the top display shows "10".

- ↳ Bottom display shows the currently set water treatment:
 - ↳ "00" = deactivated
 - ↳ "01" = demineralisation cartridge
 - ↳ "02" = reverse osmosis system

- ▶ Set using the Standard programme key (2) or Drain key.

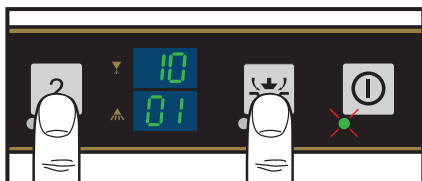

- ↳ The ON/Escape key LED flashes.

- ▶ The value is saved by pressing the ON/Escape key for 3 sec.



- ↳ The ON/Escape key LED illuminates for 3 sec.

- ▶ Open the door to escape and exit the menu.

9 Display of faults and information

9.1 Error

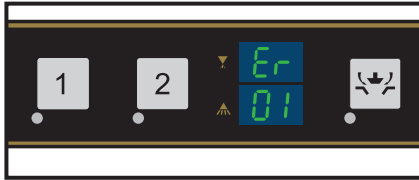

- ▶ “Er” appears in the top display.

- ▶ The error code is shown in the bottom display (see table).

Error code	Reason	Remedy
01	Boiler sensor temperature exceeds setpoint.	Contact your HOBART Service Partner.
02	Boiler sensor temperature below setpoint.	Contact your HOBART Service Partner.
03	Hot water tank thermostop in wash programme.	Contact your HOBART Service Partner.
05	Tank sensor temperature exceeds setpoint.	Contact your HOBART Service Partner.
06	Tank sensor temperature below setpoint.	Contact your HOBART Service Partner.
07	Total value of pressure sensor for boiler exceeded.	Contact your HOBART Service Partner.
08	Total value of pressure sensor for boiler below setpoint.	Contact your HOBART Service Partner.
09	Total value of pressure sensor for tank exceeded.	Contact your HOBART Service Partner.
10	Total value of pressure sensor tank below setpoint.	Contact your HOBART Service Partner.
12	Water level regulation in wash tank failed.	Contact your HOBART Service Partner.
13	Filling programme monitor pressure sensor tank.	Pump out machine.
14	Wash tank draining in pump out programme for pressure sensor tank.	Clean the drain hose if necessary and pump-out the machine again.
17	Filling monitoring by impeller sensor.	Check water supply.
18	Filling monitoring by measuring the water level in the boiler.	Check water supply.
21	Filling programme aborted.	Close door.
28	Fill level of wash tank too low at programme start.	Top up water and then run the wash programme.
29	Capacity of external water treatment unit exhausted.	Replace part or full desalination cartridge.

Display of faults and information

9.2 Information

Error code	Reason	Remedy
SA Lt	Regenerating salt depleted.	Refill regenerating salt (see section 6.3).



- ▶ If salt deficiency occurs during operation, the top display shows “SA”, the bottom display shows “Lt”.

10 Troubleshooting guide

10.1 Poor wash result

Fault type	Possible cause	Remedy
Washware not clean.	Wash arm stiff (must rotate easily by hand).	Remove wash arms and clean them thoroughly. Also check water outlet from machine to wash arm is clear.
	Wash arm nozzles are clogged (visual check).	Remove wash arm, remove cleaning caps and rinse wash arm thoroughly until all soiling is removed. Replace cleaning caps.
	Rinse nozzles clogged (usually by lime deposit).	Remove rinse arms and descale them in separate container. Check site softening system for function.
	Detergent concentration is too low or too high.	Check detergent concentration setting.
	Coarse strainer clogged.	Remove, empty and clean strainer.
	Fine strainer clogged or obstructed by lime deposits.	Remove fine strainer. If heavily soiled, soak in a vinegar solution. Then clean it thoroughly with a brush until the pores are free. The fine strainer should generally be cleaned daily (see operating instructions).
	Wrong programme selected for heavily soiled washware.	Select programme with longer wash cycle.
Washware or glasses dry poorly.	Rinse aid dosing too low.	Increase concentration (see operating instructions).
	Washware still greasy.	Detergent concentration too low: increase (see operation instructions). Check if detergent is appropriate. If not, choose a stronger one. Drain contaminated water and refill machine. Ensure better pre-scrapping of the washware.
	Rack is not suitable for type of dishes (sloping).	Use appropriate racks to create a sloping position which allows water to drain away from cavities.
	Washware remains in the machine too long at the end of wash cycle.	Remove washware as soon as cycle is completed to enable it to dry.

Troubleshooting guide

Fault type	Possible cause	Remedy
Streaks and spots on washware or glasses.	Rinse aid concentration too high (stripe or bubble formation).	Reduce concentration (see operating instructions).
	Hard water or high mineral content.	Check water quality. Every local water works holds data on the composition of the water they supply and will provide these on request. Reference values: Ideal calcium value: 0 – 3°d (total hardness). Ideal mineral content value: for glasses, max. conductivity 100 µS/cm, for dishes, still viable to max. 400 µS/cm.
	Rack is not suitable for type of dishes (sloping).	Use appropriate racks to create a sloping position which allows water to drain away from cavities.
	Inadequate rinse aid dosing causes stains.	Increase rinse aid concentration (see operating instructions).
	Machines with integrated softener: use of wrong salt (e.g. tablets).	Do not use salt tablets.

10.2 Other faults

Fault type	Potential causes	Remedy
Glasses are totally or partially cloudy.	Surface of glasses is rough and porous, this is called glass corrosion.	Use new glasses, this is not caused by a malfunction on the machine.
Glass/dish breakage.	Use of unsuitable dish or glass racks.	Use suitable racks.

10.3 Malfunctions

Fault type	Potential causes	Remedy
Machine switches off suddenly during operation.	Machine coupled to a maximum system or locked against other current consumers.	Have machine connected separately (electrician!).
	A site fuse has tripped.	Check site fuses.
	Temperature sensor/pressure transmitter, boiler or tank defective.	Contact your Service Partner.

11 Maintenance



In order to maintain the warranty, as well as a permanently safe, efficient, and trouble-free operation of the machine(s), the required maintenance must be carried out by authorized service technicians.

We therefore recommend the conclusion of an inspection and maintenance contract, which guarantees qualified support by specially trained service technicians according to a time schedule based on the operating conditions.

Genuine spare parts must be used for repairs and wearing part replacements. Wearing parts include dosing hoses, rinse arm bearings, etc.

In Germany, your HOBART machines are governed by the Ordinance on Industrial Health and Safety and must be inspected by a qualified electrician in accordance with the intervals specified by the Institute for Work and Health of the German Social Accident Insurance [DGUV V3 (BGV A3)].

Disposal

12 Disposal



The machine operator is responsible for disposing of the machine and its operating materials correctly and in accordance with environmental regulations. Observe the national and local legal provisions and regulations.

HOBART GmbH
ecomax by HOBART
Robert-Bosch-Str. 17
77656 Offenburg
Deutschland
Tel.: +49 (0)1803 66 29
Fax: +49 (0)1803 63 29.600-23 19
E-Mail: info@ecomaxbyhobart.de
Internet: www.ecomaxbyhobart.de

HOBART Export
Robert-Bosch-Str. 17
77656 Offenburg
Germany
Phone: +49 (0)781.600-2820
Fax: +49 (0)781.600-2819
E-Mail: info-export@hobart.de
Internet: www.hobart-export.com

Hobart UK.
Southgate Way,
Orton Southgate,
Peterborough
PE2 6GN
United Kingdom
Tel.: +44 (0)844 888 7777
Republic of Ireland: +353 (0)1246 0248
Fax: +44 (0)1733 361 347
E-mail: sales@hobartuk.com
Internet: www.hobartuk.com

Compagnie HOBART SAS
Allée du 1er mai
77183 Croissy Beaubourg
FRANCE
Tel: +33 (0)1 64 11 60 00
Fax: +33 (0)1 64 11 60 10
E-mail: contact@hobart.fr
Internet: www.hobart.fr

Hobart Nederland BV
Pompmolenlaan 12
3447 GK Woerden
Telefoon +31 (0)348 462626
Fax: +31 (0)348 430117
E-mail: info@hobartnederland.nl
Internet: www.hobartnederland.nl

Hobart Foster Belgium bvba/sprl
Industriestraat 6
1910 Kampenhout
Telefoon +32 (0) 16.60.60.40
Fax +32 (0) 16.60.59.88
E-mail: info@hobart.be
Internet: www.hobart.be

Hobart Norge
Gamle Drammenvei 120
N-1363 Høvik
Tlf.: +47-67109800
Fax.: +47-67109801
E-post: post@hobart.no
Hjemmeside: www.hobart.no

Hobart Scandinavia ApS
Håndværkerbyen 27
2670 Greve
Danmark
Tlf.: +45 4390 5012
Fax.: +45 4390 5002
E-mail: salg@hobart.dk
Internet: www.hobart.dk

Hobart Sweden/Finland
Tel: +46 8 584 50 920
E-mail: info@hobart.se
Internet: www.hobart.se

Australia
Hobart Food Equipment
Unit 1 / 2 Picken Street,
Silverwater NSW, 2128
Tel: +61 1800 462 278
Fax: +61 02 9714 0222
E-mail: sales@hobartfood.com.au
Internet: www.hobartequipment.com.au

HOBART China
15th Floor, Building A
New Caohejing International Business
Center
391 Gui Ping Road
Shanghai, 200233
Telephone: +86 (0)21 34612000
Fax: +86 (0)21 34617166
Internet: www.hobartchina.com

HOBART Korea LLC
7th Floor, Woonsan Bldg, 108, Bangi-dong
Songpa-gu, Seoul 138-050
Korea
Telephone: +82 2 34 43 69 01
Fax: +82 2 34 43 69 05
E-mail: contact@hobart.co.kr
Internet: www.hobart.co.kr

HOBART (Japan) K.K.
6-16-16 Minami-Oi, Shinagawa-ku,
Tokyo 140-0013
Japan
Telephone: +81 3 5767 8670
Fax: +81 3 5767 8675
E-mail: info@hobart.co.jp
Internet: www.hobart.co.jp

Hobart International (S) Pte Ltd
158, Kallang Way, #06-03/05
Singapore 349245
Telephone: +65 6846 7117
Fax: +65 6846 0991
E-mail: enquiry@hobart.com.sg
Internet: <http://www.hobart.com.sg>

Hobart Thailand
43 Thai CC Tower Building,
31st FL, Room No. 310-311,
South Sathorn Rd., Yannawa,
Sathorn, Bangkok, 10120
Thailand
Telephone: +66(0)2-675-6279-81
Fax: +66(0)2-675-6282
E-mail: enquiry@hobarthailand.com
Internet: <http://www.hobarthailand.com>

ITW India Pvt Ltd.
501-502 Vipul Trade Centre
Sector 48 Sohna Road
Gurgaon 122001
Telephone: +91 124 4245430
Fax: +91 124 4245432