

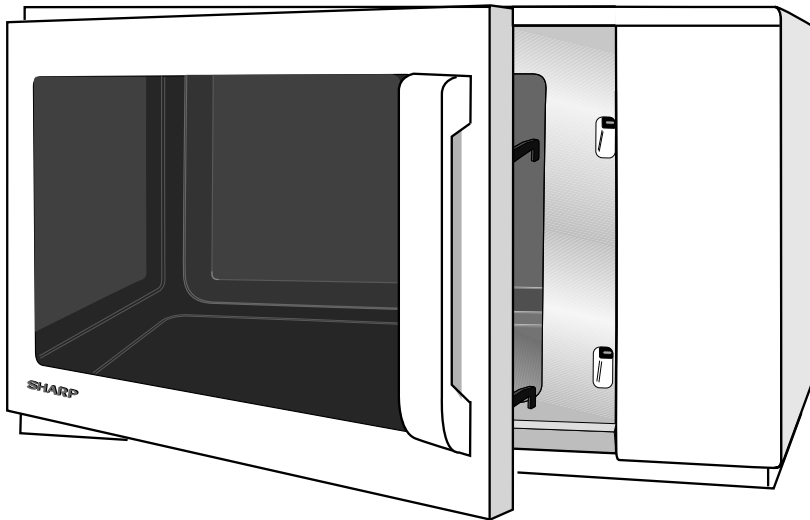

SHARP



Model

R-24AT
R-22AT

COMMERCIAL MICROWAVE OVEN OPERATION MANUAL

(with terms of Guarantee)

OPERATION MANUAL

This operation manual contains important information which you should read carefully before using your microwave oven.

IMPORTANT: There may be a serious risk to health if this operation manual is not followed or if the oven is modified so that it operates with the door open.

INTELLIGENT THINKING



OVEN

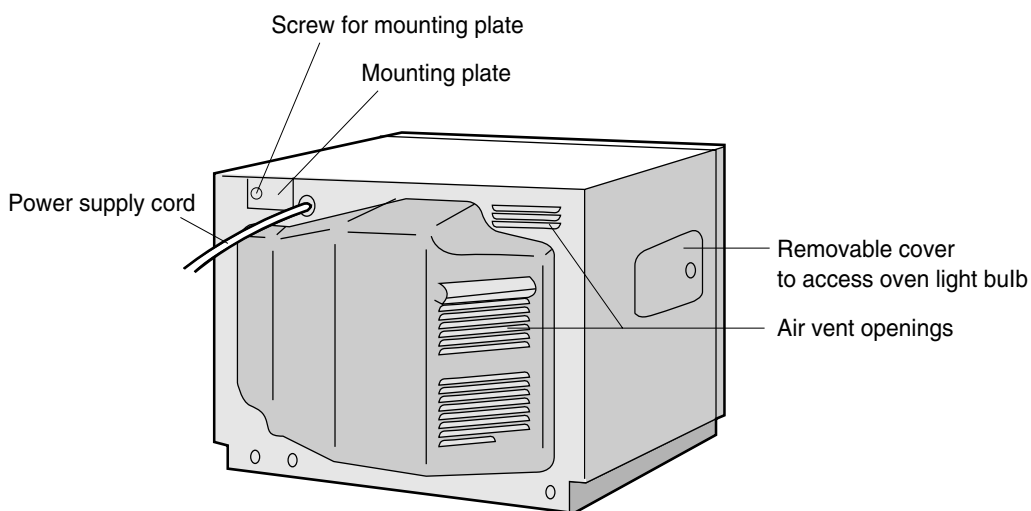
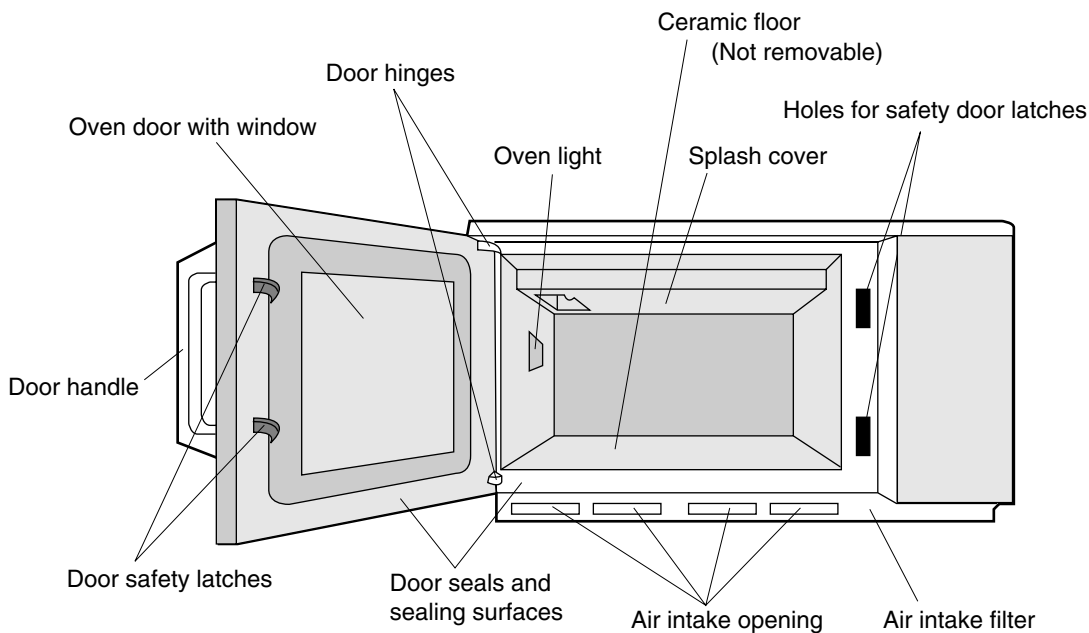

ACCESSORIES:

Check to make sure the following accessories are supplied:

- Operation manual
- Menu Sticker
Enter cooking times or dish menus in this sticker and attach to the control panel.
- Caution sheet (Special Instructions and Warnings: part number TCAUHA257WRR0)



CONTROL PANEL

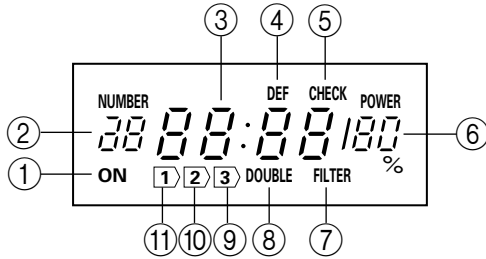

DISPLAY AND INDICATORS

- ① Heating indicator:
This indicator shows heating in progress
- ② Memory number indicator
- ③ TIME display
- ④ EXPRESS DEFROST indicator
- ⑤ Check mode indicator
- ⑥ POWER LEVEL display:
Percentage of microwave power is indicated
- ⑦ Filter indicator
- ⑧ Double quantity mode indicator
- ⑨ 3rd sequence indicator
- ⑩ 2nd sequence indicator
- ⑪ 1st sequence indicator

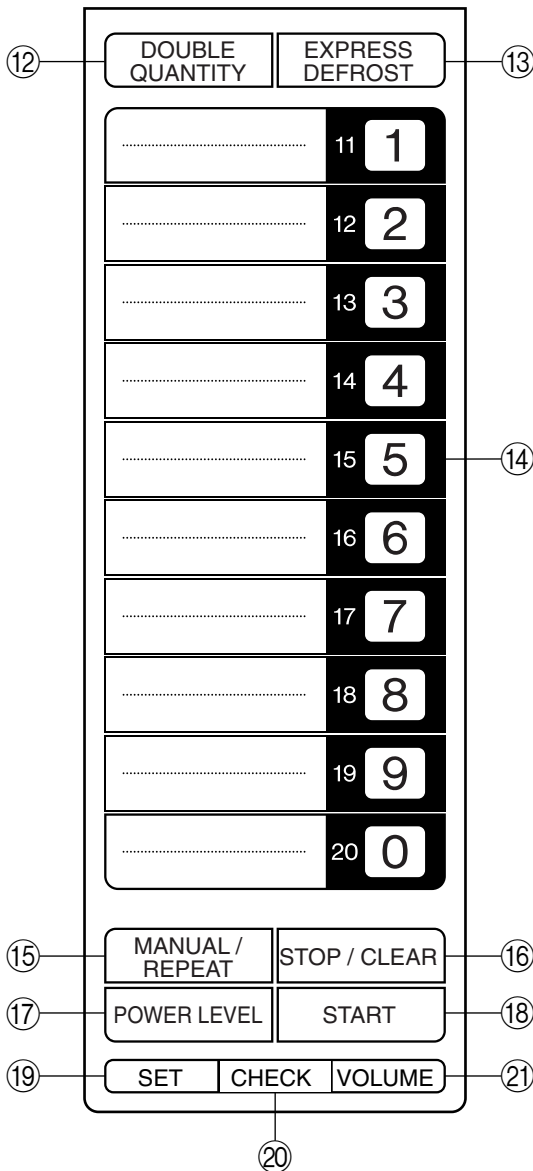

OPERATING PADS

- ⑫ Double quantity pad
- ⑬ EXPRESS DEFROST pad
- ⑭ NUMBER pads for time and memory programming
- ⑮ MANUAL/REPEAT pad
- ⑯ STOP/CLEAR pad; Press to stop operation of oven and clear remaining heating time
- ⑰ POWER LEVEL pad for setting variable power level
- ⑱ START pad. Press to operate oven after door is closed and time is set
- ⑲ SET pad for setting memory
- ⑳ CHECK pad for checking memory
- ㉑ VOLUME pad for setting sound level

OVEN FEATURES



C ONTENTS

○ Oven Features with Control Panel	1 - 2
○ Contents	3
○ Important Safety Instructions	4
○ Installation	4 - 5
○ Before Operation	6
○ How to Operate the Oven:	
Memory Cooking	6
Note for memory cooking	6
Memory programme entry	7
Cooking with memory	8
Memory check	9
Manual Cooking	10
Note for manual cooking	10
Time cook	10
Multiple sequence cooking	11
Repeat cook	11
Express defrost	11
Other Convenient Features	12
Counter check	12
Counter clear	13
Information with error messages	13
Information for filter indicator	13
○ Cooking Advice:	
Suitable Cookware	14
Food Handling & Preparation	15
Advice for Defrosting	16
Advice for Reheating	17
○ Charts:	
Defrosting Chart	18 - 19
Cooking Chart	20 - 22
Reheating Chart	23 - 27
○ Cleaning & Maintenance	28
○ Troubleshooting	29
○ To replace the mains plug	30
○ Calling for Service	30
○ Specifications	Back Cover



I MPORTANT SAFETY INSTRUCTIONS

IMPORTANT: PLEASE READ CAREFULLY AND KEEP FOR FUTURE REFERENCE.

Oven Use:

- The oven is for food preparation only. Never operate when empty.
- Do not leave or store anything inside the oven when not in use.
- Never attempt to use the oven with the door open. It is important not to tamper with the door safety latches. This may result in exposure to microwave energy.
- Never operate the oven with any object caught in the door sealing surfaces, this again may cause microwave leakage.
- Do not insert fingers or objects in the holes of the door latches or air vent openings as this may damage the oven and cause an electric shock.
- If water or food drops inside the air vent openings switch off the oven immediately, unplug it and call a Service Technician appointed by SHARP.
- Never attempt to move the oven while it is operating.
- Do not use the oven near a steamer or a fryer.
- Always wipe up spills on the ceramic floor and splashes on the walls after cooking. If you leave grease on the ceramic floor and walls it may overheat, smoke or even catch fire when next using your oven.

- After each use wipe the splash cover on the ceiling of the oven with a soft damp cloth to remove any splashes. If you leave grease on the splash cover it may overheat, smoke or even catch fire when next using your oven.

⚠ WARNING:

Only allow children to use the oven without supervision when adequate instruction has been given so that the child is able to use the oven in a safe way and understands the hazards of improper use.

Pacemaker: If you have a heart pacemaker, consult your doctor or the pacemaker manufacturer prior to oven use.

Fire: If food overheats, starts to smoke or burn: Keep the oven door closed; turn the oven off; switch off the power at the socket and disconnect the plug from the socket. Failure to follow this procedure may result in fire and oven damage.

Liquids: Take care when microwaving liquids and beverages. To prevent delayed eruptive boiling of liquid and possible scalding: Stir liquid prior to and during heating/reheating, let liquid stand in the oven at the end of cooking.

I NSTALLATION

⚠ WARNING:

Inspect the Oven:

Check the oven carefully for damage before and regularly after installation.

- **Make sure the door closes properly, that it is not misaligned or warped.**
- **Check the hinges and door safety latches are not broken or loose.**
- **Ensure the door seal and sealing surfaces are not damaged.**
- **Inspect the oven interior and door for dents.**

Caution Sheet:

Always keep the caution sheet (Special Instructions and Warnings) close to the oven for your reference.

Important:

If any damage is apparent, do not operate the oven in any way. Contact your dealer or an authorised Service Technician appointed by SHARP.

- 1 Remove all packing materials. Remove the protective film (blue film) from the outer case cabinet (if covered). Do not remove the plastic film from the inside of the oven window as this protects it from dirt.
- 2 Place oven on a secure, level surface, strong enough to take the oven weight, plus the heaviest item likely to be cooked in the oven.
- 3 Ensure there is a minimum free space above the oven of 25 cm.
- 4 Do not place the oven where heat, moisture or high humidity are generated, (for example, near or above a conventional oven) or near combustible materials (for example, curtains). Do not block or obstruct air vent openings, as obstructions may ignite due to the emission of hot air.
- 5 Make sure the power supply cord is undamaged (See Installation next page) and that it does not run under the oven or over any hot or sharp surfaces.



- 6 The socket must be readily accessible so that it can be easily unplugged in an emergency.
- 7 Do not use the oven outdoors.
- 8 Two ovens can be installed together by placing one on top of another. Follow these instructions.
- 8-1) Place the oven A and position the oven B on top of the oven A as shown in the figure A.
- 8-2) Remove the single screw (a) holding the mounting plate A to the rear cabinet of the oven A. And remove the mounting plate A.
- 8-3) Remove the single screw (b) from the rear cabinet of the oven B, as shown in the figure A.
- 8-4) Reinstall the mounting plate A to the rear cabinet of the oven B with the single screw (b) removed, as shown in the figure A.
- 8-5) Hold the mounting plate A to the rear cabinet of the oven A with the single screw (a), as shown in the figure A.
- 8-6) Remove the screw (a) holding the mounting plate B to the rear cabinet of the oven B. And remove the mounting plate B from the oven B. See the figure A.
- 8-7) Install the screw (a) to its position again.
- 8-8) Remove the screw (c) from the oven A.
- 8-9) Remove the screw (d) from the oven B.
- 8-10) Turn the removed mounting plate B over and then using the removed screw (c) and (d), attach the mounting plate B, as shown in the figure A.

Figure A

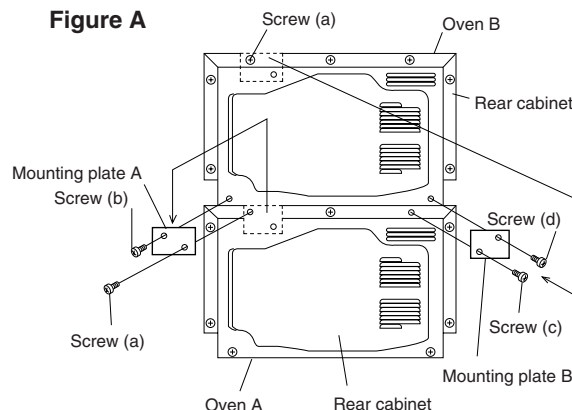
**WARNING:**

In situations where two ovens are installed together by placing one on top of another,

- 1) Use the two mounting plates for fixing the two ovens.
- 2) Make sure that the power supply cord is not caught between the two ovens.
- 3) Do not install more than one oven on top of another.
- 4) Do not lose the removed screws.

WARNING:

It is hazardous for anyone other than a Service Technician, approved by SHARP to carry out any service or repair operation which involves the removal of a cover which gives protection against exposure to microwave energy.

BUILDING-IN-KIT

This oven is not designed to be built into a kitchen unit.

IMPORTANT! ELECTRICAL CONNECTION

- Do not allow water to come into contact with the power supply cord or plug.
- Insert the plug properly into the socket as the plug may otherwise overheat and catch fire.
- Do not connect other appliances to the same socket using an adaptor plug as it may cause the wiring to overheat and catch fire.
- If the plug or socket is loose or the power supply cord is damaged, do not operate the oven, it must be replaced by the special power cord. Contact your dealer or a Service Technician appointed by SHARP. A defective plug, power supply cord or socket may overheat and catch fire during operation or cause an electrical shock.

- When removing the plug from the socket always grip the plug, never the mains lead as this may damage the power supply cord and the connections inside the plug.
- The product is fitted with a non-rewireable (moulded) plug. Should it not be suitable for the socket outlet in your kitchen, remove the plug and fit an appropriate type, observing the wiring code given in "To replace the mains plug" on page 30.

The fuse from a cut-off plug should be removed and the plug disposed of in safe manner. Under no circumstances should the cut-off plug be inserted into a socket outlet as serious electrical shock may occur. The plug must not be used without the fuse cover fitted.

When replacing the plug please ensure that you use a BSI or ASTA approved plug to BS1363, this should be fitted with a brown coloured 13 amp fuse approved by BSI or ASTA to BS1362. If you have any doubt about electrical connection seek the help of a qualified electrician.

WARNING
THIS APPLIANCE MUST BE EARTHED.

To wire an appropriate plug, follow the wiring code given in "To replace the mains plug" on page 30.



BEFORE OPERATION

- When you first connect the microwave oven to an electrical socket, the digital display will show .
- You can input the pads only when the door is closed.
- Oven lamp and fan motor work for 1 minute whenever the door is opened or after cooking.
- The programme or check mode is cancelled when any pads are not pressed for more than 3 minutes.
- will appear on the display after the time reaches zero. It will disappear when the oven door is opened or the STOP/CLEAR pad is pressed.

VOLUME AND SOUND SETTING

There are three preset volume levels of two different sounds for your oven.

To set the volume and sound, press the SET pad twice within 2 seconds and then continue pressing the VOLUME pad until you hear the desired volume and sound.

Note: 1. The volume will decrease as you are pressing the VOLUME pad. After the lowest level, the

volume will start again at the maximum level and the sound will change to another one at the same time.

2. The audible signal will not sound when the SET pad is pressed once, however an audible signal will sound when the SET pad is pressed twice.

STOPPING THE OVEN

- If you wish to stop the oven during cooking:
 1. Press the STOP/CLEAR pad once.
 2. Open the door (except memory cooking).

To start the oven again, close the door and press the START pad within 1 minute.
- If you open the door during memory cooking, the programme is cancelled.
- If you wish to cancel a programme during cooking, press the STOP/CLEAR pad twice.
- If you wish to erase a mistake during programming, press the STOP/CLEAR pad once.

HOW TO OPERATE THE OVEN

Introduction: Microwaves are absorbed by water, sugar and fat in food and cause them to vibrate. This creates heat by friction, in the same way your hands get warm when you rub them together.

Outer areas of food are heated by microwave energy, and remaining portions by conduction. It is, therefore, important to **turn**, **rearrange** or **stir** food to ensure even heating. Where recommended, allow food to **stand**, this

is not optional but necessary to ensure thorough cooking and is particularly important for dense food, such as joints of meat.

Microwaves pass through non-metallic dishes and utensils and heat the food inside the dishes. Microwaves are reflected by metal. The oven is lined with metal and has a fine metallic mesh in the door to prevent microwave leakage. Metallic dishes are not suitable for microwaving.

MEMORY COOKING

NOTE FOR MEMORY COOKING

- This oven has 20 memory banks (1-20) which can store cooking programmes.
- The memory banks 1-10 have been programmed previously as shown in the table. These preprogrammed memory banks can be changed individually if required.
- In addition for all memory banks a magnification factor 1.8 for the double quantity is stored. The stored magnification factor can also be changed individually if required.
- Information in these memory banks is not lost due to power interruptions. If the power goes off, the oven does not need to be reprogrammed. No batteries are necessary for this type of memory.
- If you want to memorize or check the programme or cook using memory 11-20, press the desired NUMBER pad twice within 1 second.

Memory No.	Cook Time	Output Power
1	5 sec.	100%
2	10 sec.	100%
3	20 sec.	100%
4	30 sec.	100%
5	40 sec.	100%
6	50 sec.	100%
7	1 min.	100%
8	1 min. 15 sec.	100%
9	1 min. 30 sec.	100%
10	2 mins.	100%

To check the stored programmes please refer to "Memory check" on page 9.

To change the stored programmes please refer to "Memory programme entry" on pages 7-8.



MEMORY PROGRAMME ENTRY

You can change memory programmes for 20 memory banks. One, two or three sequences can be programmed. See cooking sequence chart on top of page 11 for time maximums.

MEMORIZING TIME AND POWER LEVEL

* Example : If you want to set 4 minutes at 60% as the 1st sequence and 2 minutes at 30% as the 2nd sequence for 1 serving in the memory 1.

Step	Action	Press pad	Display
1	Select set mode.	X 2 within 2 sec.	
2	Select memory number.		
3	Press MANUAL/REPEAT pad.		
4	Enter desired cooking time for 1st sequence. (4 minutes)	X 1 X 2	
5	Press POWER LEVEL pad.		
6	Enter desired power level for 1st sequence. (60%)		
7	Press MANUAL/REPEAT pad.		
8	Enter desired cooking time for 2nd sequence. (2 minutes)	X 1 X 2	
9	Press POWER LEVEL pad.		
10	Enter desired power level for 2nd sequence. (30%)		
11	Press SET pad twice to complete the setting.	X 2	

- Note:
1. If the cooking time is over the max. time, the display will show "EE9". See page 13.
 2. If your programmed time is over max. time at Double Quantity, you cannot use Double Quantity for the memory. You can cook only 1 serving.
 3. It is not necessary to press POWER LEVEL pad for 100%.
 4. At step 1, the audible signal will not sound when the SET pad is pressed once but an audible signal will sound when the SET pad is pressed twice.





CHANGING THE TIMING REQUIRED BY THE MAGNIFICATION FACTOR FOR DOUBLE QUANTITY

The magnification factor for double quantity is preset 1.8 times the single quantity cooking time, but you can alter this constant to suit your needs if the food needs more or less cooking time.

* Example: If you want to change the magnification factor to 1.67 in memory 1.

Step	Action	Press pad	Display
1	Select set mode.	X 2 within 2 sec.	
2	Press DOUBLE QUANTITY pad.		
3	Select memory number.		
4	Press MANUAL/REPEAT pad.		
5	Set the magnification factor (1.67).	 	
6	Press SET pad twice to complete the setting.	X 2	

- Note:
1. In case you want to change the magnification factor it must be set for each key separately.
 2. The magnification can be set from 0.00 to 9.99.
 3. At step 1, the audible signal will not sound when the SET pad is pressed once but an audible signal will sound when the SET pad is pressed twice.

COOKING WITH MEMORY

* Example: To cook using memory 1, which was programmed for 10 seconds at 100%.

Step 1

Select memory number.



The programme will start after 1 second.

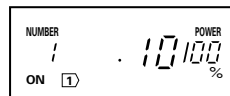

COOKING DOUBLE QUANTITY WITH MEMORY

* Example: To cook 2 servings by memory 1, (In this case the constant for double quantity is 1.8).

Step 1

Select double quantity cooking mode.

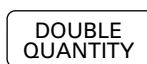

Step 2

Select memory number.

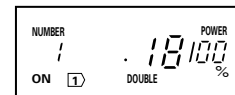

The programme will start after 1 second.

- Note:
1. If the cooking time of double quantity is over the max time (see page 10), the display will show "EE9".
 2. Double quantity means best time for cooking double quantity; it is not double the time.
 3. The "MEMORY" cooking system does not require the use of the START pad. MEMORY cannot be used to start the oven if a program is already on display.





MEMORY CHECK

You can check the information programmed into the memory.

CHECKING TIME AND POWER LEVEL

* Example: If you want to know the information that you have programmed into memory 1, this memory has been programmed for 4 minutes at 60% as the 1st sequence and 2 minutes at 30% as the 2nd sequence.

Step	Action	Press pad	Display
1	Select check mode.	<input type="button" value="CHECK"/>	
2	Select memory number. <input type="text" value="1"/>	<input type="text" value="1"/>	 Repeat
3	Cancel check mode.	<input type="button" value="CHECK"/>	

Note: When is displayed at Step 2, the memory is not set.

CHECKING THE MAGNIFICATION FACTOR FOR DOUBLE QUANTITY

* Example: If you want to know the magnification factor for double quantity in MEMORY 1. (1.67 is programmed.)

Step	Action	Press pad	Display
1	Select check mode.	<input type="button" value="CHECK"/>	
2	Select double quantity cooking mode.	<input type="button" value="DOUBLE QUANTITY"/>	
3	Select memory number. <input type="text" value="1"/>	<input type="text" value="1"/>	
4	Cancel check mode.	<input type="button" value="CHECK"/>	

Note: Magnification factor 1.80 for the double quantity is stored in all memories unless changed.



MANUAL COOKING

Your oven can be programmed for up to 3 cooking sequences and has 11 preset microwave power levels.

COOKING TIME

Cooking Sequence	Microwave power level that can be used.	Cooking time that can be used.
1 Stage only	0-100%	Max. 30 minutes
2 or 3 Stages	0-40% all stages	Max. 30 minutes any stage Max. 60 minutes for two stages Max. 90 minutes for three stages
	50-100%	Max. 30 minutes all stages

Note: If the oven is used with the power level above 40% on any stage, the maximum cooking time is 30 minutes in total.

POWER LEVEL

This model has 11 power levels. Use correct number pad after pressing POWER LEVEL pad.

Microwave POWER level	100%	90%	80%	70%	60%	50%	40%	30%	20%	10%	0%
Number pads	NONE	9	8	7	6	5	4	3	2	1	0

NOTE FOR MANUAL COOKING

- It is not necessary to press POWER LEVEL pad for 100%.
- If the cooking time is over the max. time, the display will show "EE9". See page 13.
- During cooking mode, the oven stops when the door is opened, and the programme is cancelled if the START key is not pressed within 1 minute after the door is closed.

TIME COOK

* Example: Suppose you want to cook for 2 minutes and 30 seconds at 50%.

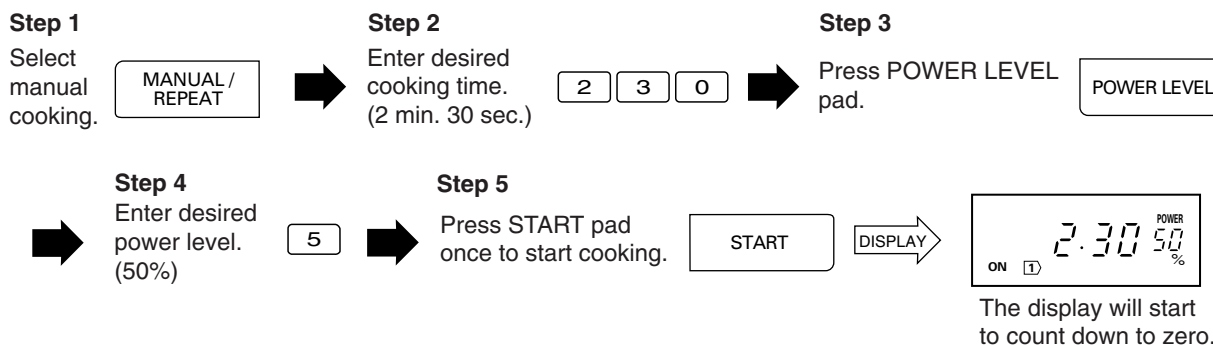



MULTIPLE SEQUENCE COOKING

* Example: To cook for 5 minutes at 70% and then continue to cook for 20 minutes at 30%.

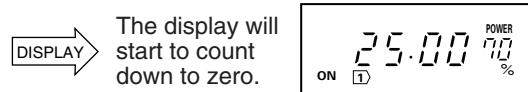
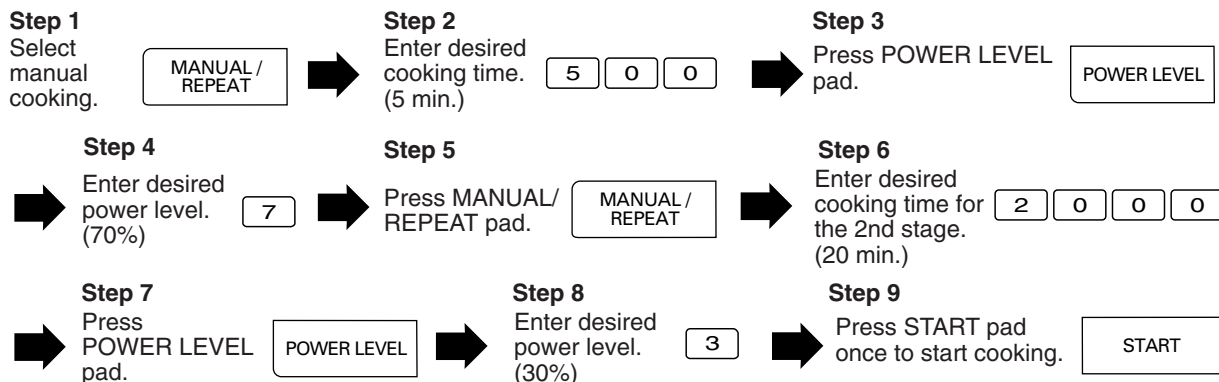

Note: When you press START pad, the display will show the total cooking time.

REPEAT COOK

Your oven can remember the last manual programme.

* Example: To cook with the last programme, which was programmed for 2 minutes and 30 seconds at 50%.

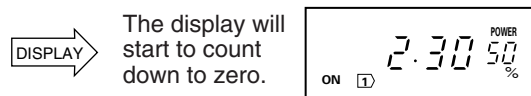
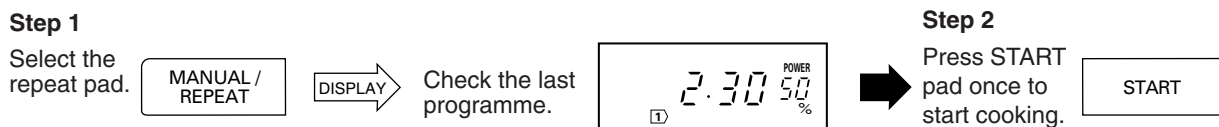

EXPRESS DEFROST

You can defrost the food listed on the Express Defrost chart on page 19 easily by using the EXPRESS DEFROST pad. The oven is pre-programmed with a time/power level cycle so that the food listed on the chart is defrosted evenly and faster.

Select the food from the chart and then calculate total defrosting time from the chart. Then enter the time you have calculated and start the oven.

* Example: To defrost 450g (1lb.) beef steak for 3 minutes in the R-22AT, (2 minutes 30 seconds in the R-24AT).

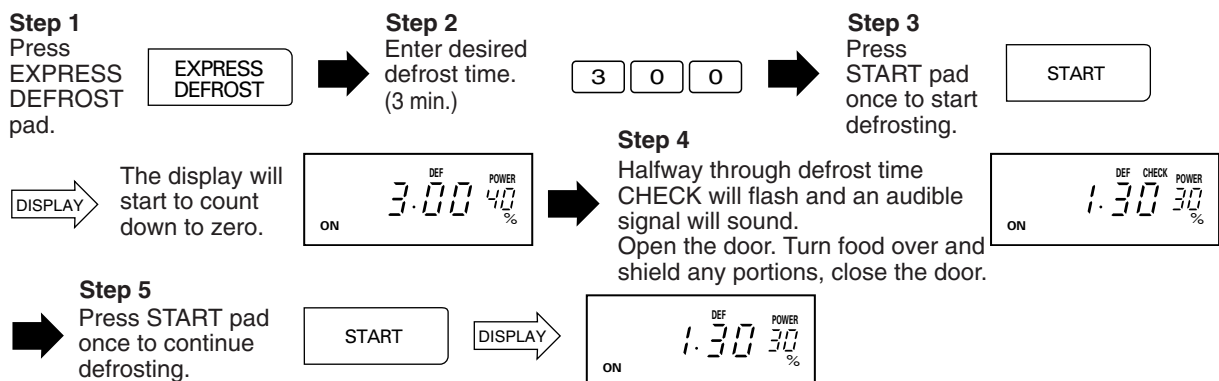

TIPS: Allow foods to stand a few minutes after defrosting to equalize the temperature for better cooking results. Check food after standing. If additional time is needed, continue to defrost with 20% power and additional time. Foods that are the same thickness throughout defrost better. If foods have varied thickness, it may be necessary to shield the thin edges with small flat pieces of aluminum foil to prevent overdefrosting. For foods not listed in the chart refer to the manual defrost chart on pages 18-19.



OTHER CONVENIENT FEATURES

COUNTER CHECK

Set counter to "0" before using oven for the first time. See page 13. With this feature you can check how many times the oven was used.

* Example: Suppose you want to know the total operated times and the number operated by each memory/function.
 If the oven was operated 8268 times and memory 1 was used 513 times and memory 12 was used 228 times, and manual cooking was used 3339 times, and Express Defrost was used 856 times.

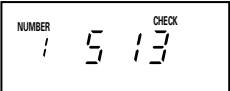
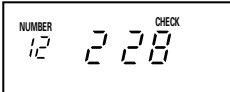
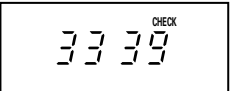
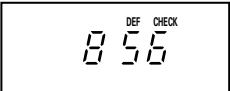
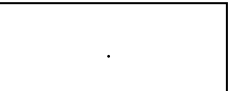
Step	Action	Press pad	Display
1	Select check mode for total usage.	CHECK X 2	 (Total times used)
2	To check memory 1 usage, press NUMBER pad 1 .	1	 (Times memory 1 used)
	To check memory 12 usage, press NUMBER pad 2 twice.	2 X 2	 (Times memory 12 used)
	To check manual cooking usage, press MANUAL/REPEAT pad.	MANUAL / REPEAT	 (Times manual cooking used)
	To check EXPRESS DEFROST usage, press EXPRESS DEFROST pad.	EXPRESS DEFROST	 (Times EXPRESS DEFROST used)
3	Cancel check mode.	CHECK	

Note: Each counter can count the times up to 9999, and then it will return to 0 if it is over 9999.



COUNTER CLEAR

Each number of times can be cleared.

* Suppose you want to clear the times of memory 1.

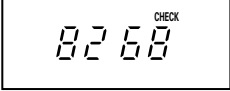
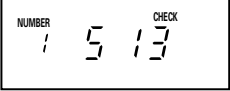
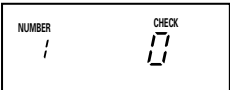
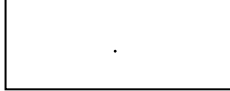
Step	Action	Press pad	Display
1	Select check mode.	<input type="button" value="CHECK"/> X 2	 (Total times used)
2	Press NUMBER pad <input type="button" value="1"/> .	<input type="button" value="1"/>	 (Times memory 1 was used)
3	Press SET pad.	<input type="button" value="SET"/>	
4	Cancel check mode.	<input type="button" value="CHECK"/>	

Note: 1. To clear times of manual cooking, press MANUAL/REPEAT pad at Step 2 instead of NUMBER pad.
 To clear times of EXPRESS DEFROST cooking, press EXPRESS DEFROST pad at Step 2 instead of NUMBER pad.
 2. To clear total using times, miss out Step 2.

INFORMATION WITH ERROR MESSAGES

If ERROR messages are displayed, follow the instructions below.

ERROR MESSAGES	
EE1 EE2 EE3 EE6 EE8 EE0 EE10 EE16	Please contact your dealer or an authorized service agent because the oven is malfunctioning.
EE7	Exhaust air temperature is too high. Check that nothing is blocking the vent openings and air intake openings or that room temperature is too hot or that oven cavity is empty during operation. Correct, press STOP/CLEAR pad and try again after a few minutes.
EE9	Cooking time exceeds the max. time. Press STOP/CLEAR pad and programme again.
EE17	Magnetron temperture is too high. Press STOP/CLEAR pad and try again after a few minutes.

INFORMATION FOR FILTER INDICATOR

1. Clean the air intake filter when the FILTER indicator ligfts up. See page 28. The FILTER indicator will light up when the oven has been operated for about 200 hours in total.
2. To cancel FILTER indicator press the START pad. The oven will start to count the operation time automatically again when the FILTER indicator is cancelled.



COOKING ADVICE



WARNING - Always attend the oven when in use.









Carefully follow the SHARP Operation Manual at all times. If you exceed recommended cooking times and/or use power levels that are too high, food may overheat, burn, and in extreme circumstances, catch fire and damage the oven.

- The microwave power level will default to 100% unless you press the **POWER LEVEL** button for the desired setting. Take care when heating foods with high sugar or fat content, e.g, Christmas pudding, mince pies and fruit cakes. Before use, check that utensils are suitable for use in microwave ovens.
- **Lids:** Always remove lids from food jars and containers before using them in the oven. If you do not, steam and pressure will build up inside and the container may explode. Take care when heating contents in babies bottles, see page 15.
- Do not cook eggs in their shell as they will explode. **Do not** heat canned potatoes in the microwave oven as they may burst.

For microwaving, use only those utensils suitable for microwave cookery as indicated below.

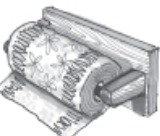
A variety of cookware can be used for microwaving. Round/oval dishes rather than square/oblong ones are recommended, as food in the corners tends to overcook.

SUITABLE COOKWARE

COOKWARE	SUITABLE FOR MICROWAVING
<p>Heat resistant glass, (e.g. Pyrex®, Fire King®, Corning Ware ®).</p> 	<p>YES</p>
<p>Microwave-safe plastic cookware.</p> 	<p>YES</p>
<p>Microwave cling film , microwave roasting bags.</p> 	<p>YES Microwave cling film and bags must be vented for steam to escape, pierce in 4-5 places. Do not use plastic or metal ties as they may melt or catch fire due to 'arcing'.</p>
<p>Heat resistant china and ceramics.</p> 	<p>YES Except for dishes with metallic decoration.</p>
<p>Disposable containers: Thin plastic, paper, straw and wooden containers.</p> 	<p>YES Always attend the oven closely. Look at the oven from time to time when cooking or reheating food in disposable containers of plastic, paper or other combustible material. Only use for warming food. Pay special attention as over-heating may cause a fire in your oven.</p>
<p>Kitchen paper.</p> 	<p>YES Always attend the oven closely. Only use to absorb fat and moisture when warming food. Pay special attention as overheating may cause a fire in your oven.</p>
<p>Browning dishes & self-heating packages.</p> 	<p>YES Always place on an up-turned plate on the turntable to prevent heat stress. Follow manufacturer's instructions. Be careful as these become very hot. Popcorn: Only use microwave popcorn within recommended packaging (follow popcorn manufacturer's instructions). Never use oil unless the manufacturer recommends and never cook for longer than instructed.</p>
<p>Metal cookware.</p> 	<p>NO</p>
<p>Aluminium foil & foil containers, made from "Microfoil®".</p> 	<p>YES Use small pieces of aluminium foil to shield food from overheating. Keep foil at least 2cm from the oven walls. Foil containers are not recommended unless specified by the manufacturer, e.g. MicroFoil®, follow instructions carefully.</p>





⚠ Face & Hands: Always use oven gloves to remove food or cookware from the oven. Stand back when opening the oven door to allow heat or steam to disperse. When removing covers (such as cling-film), opening roasting bags or popcorn packaging, direct steam away from face and hands.

Check the temperature of food and drink and stir (before serving). Take special care when serving food to babies, children or the elderly. the contents of feeding bottles and baby food jars should be stirred or shaken and the temperature checked before consumption to avoid burns.

FOOD HANDLING & PREPARATION

Stir, turn & stand



For even cooking stir, turn or rearrange food during cooking. Where recommended, leave food to stand after cooking or defrosting.

Initial temperature



The initial temperature of food affects the amount of cooking time needed, for example, chilled food requires more cooking than food at room temperature. The temperature of the container is not a true indication of the temperature of the food or drink. Cut into foods with fillings, for example, jam doughnuts, to release heat or steam.

Piercing



Food with skin (e.g. potatoes, apples, fish, sausages, chicken), or with membrane (e.g. egg whites/yolks), must be pierced in several places before cooking or reheating. If not, steam will build up and may cause food to explode.

Arrangement



Place thickest parts of food on the outside of the dish, e.g. place the meaty ends of chicken drumsticks on the outside of the dish.

Covering

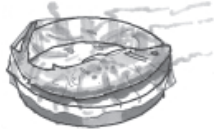

Fish, vegetables and certain other foods benefit from being covered during microwave cookery, follow recommendations where given and use vented microwave cling film or a suitable lid.

Size & shape



Food size and shape affect the amount of cooking time needed. When cooking more than one portion of the same food ensure they are of a similar size and shape.

Density & quantity



Food density and quantity affect the amount of cooking time needed, for example, potatoes require more cooking than peas; four potatoes will take longer to cook than two.

Composition & quality



Food high in fat or sugar (Christmas pudding, mince pies) requires less heating time and should be watched, over-heating can lead to fire. Use good quality ingredients for microwaving. Economical cuts of meat can be used for casseroles.

Hygiene



Food hygiene standards (storage, handling and preparation) apply to microwaving. Always store convenience foods as recommended by the food manufacturer and keep no longer than the "Use By" date.



ADVICE FOR DEFROSTING

Meat joints

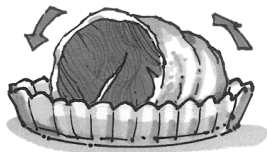

Place in a flan dish, turn over at least 4-5 times during defrosting, shield any warm areas with small, flat pieces of foil. After defrosting, wrap in foil and allow meat to stand for 1-2 hours, until thoroughly defrosted.

Poultry

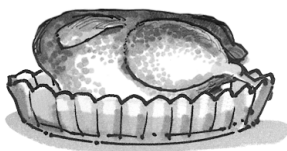

Place in a flan dish, turn over at least 3-4 times during defrosting, shield any warm areas with small, pieces of foil. After defrosting, wrap in foil and allow poultry to stand for 1-2 hours, until thoroughly defrosted.

NOTE: Do not defrost poultry with giblets.

Steak, Chops & Chicken Portions



Place in a flan dish, separate during defrosting and turn over at least 2-3 times. Shield if necessary.

Cubed & Minced Meat



Place in a bowl, remove defrosted parts and turn over at least 3-4 times during defrosting.

Whole fish & Fillets



Place in a flan dish, separate and turn over at least twice during defrosting. Shield if necessary.

Prepacked Frozen Foods



Remove packaging, including any foil and place in a suitable dish.

NOTES:

- To defrost food, use either 30% or 10% microwave power.
- Shield warm areas with small pieces of foil if necessary.
- It is important to turn food over, separate (where appropriate) and rearrange to ensure even defrosting.
- Standing time is necessary after defrosting to ensure thorough defrosting.



ADVICE FOR REHEATING



WARNINGS:

Oil & Fat: Never heat oil or fat for deep frying as this may lead to overheating and fire. Stand back when opening the oven door to allow heat or steam to disperse. When removing covers (such as cling-film), opening roasting bags or popcorn packaging, direct steam away from face and hands.

Never heat liquids in narrow-necked containers, as this could result in the contents erupting from the container and may cause burns.

- Remove food from foil or metal containers before reheating.
- Reheating times will be affected by the shape, depth, quantity and temperature of food together with the size, shape and material of the container.
- To avoid overheating and fire, special care must be taken when reheating foods with a high sugar or fat content, for example, mince pies, Christmas pudding.
- Canned potatoes should not be heated in the microwave oven, follow the manufacturers' instructions on the can.

Plated meals



Remove any poultry or meat portions, reheat these separately, see below. Place smaller items of food to the centre of the plate, larger and thicker foods to the edge. Cover with vented microwave cling film and reheat on 50%, stir/rearrange halfway through reheating. Ensure thoroughly reheated before serving.

Casseroles



Cover with vented microwave cling film or a suitable lid, reheat on 50%. Stir frequently to ensure even reheating.

Poultry portions



Place thickest parts of the portions on the outside of the dish, cover with microwave cling film and reheat on 70%. Turn over halfway through reheating.

NOTE: Ensure poultry is thoroughly reheated, before serving.

Sliced meat



Cover with vented microwave cling film and reheat on 50%. Rearrange at least once to ensure even reheating.

NOTE: Ensure meat is thoroughly reheated before serving.

Pies



Place pies on plate or in a flan dish. Reheat meat pies on 70% and fruit pies on 50%.

Vegetables



Cover with vented microwave cling film or suitable lid and reheat on 50%. Stir at least once during reheating.



D E Frosting Chart

MANUAL DEFROSTING

FOOD	DEFROSTING TIME		MICROWAVE POWER LEVEL	METHOD
	R-24AT	R-22AT		
Beef, Lamb & Pork Joints (uncooked)	8 mins /450g (1lb)	13-14 mins	LOW (10%)	<ol style="list-style-type: none"> Place on a large plate. Turn over 4-5 times during defrosting. After defrosting, wrap in foil and leave to stand for 1-2 hours or until thoroughly defrosted. <p>NOTE: If necessary, small pieces of aluminium foil can be used to shield small areas of meat which may become warm during defrosting.</p>
Whole Poultry (uncooked)	6-7 mins /450g (1lb)	13 mins	LOW (10%)	As above
Minced Beef (uncooked)	3-4 mins /450g (1lb)	5-6 mins	MEDIUM LOW (30%)	<ol style="list-style-type: none"> Place on a plate or in a flan dish. Turn over 2-3 times during defrosting, removing defrosted mince each time. After defrosting, cover any frozen mince remaining with aluminium foil for 15-20 minutes or until thoroughly defrosted.
Sausages (uncooked)			LOW (10%)	<ol style="list-style-type: none"> Place on a large plate, in a single layer if possible. Turn over 2-3 times during defrosting and separate if necessary. After defrosting, cover with aluminium foil and leave to stand for 15-20 minutes or until thoroughly defrosted.
	Thick Thin	8-9 mins 5-6 mins		
Bacon (uncooked)	5-6 mins /450g (1lb)	7-8 mins	LOW (10%)	<ol style="list-style-type: none"> Place on a plate. Separate and re-arrange 3-4 times during defrosting. After defrosting, cover with aluminium foil and leave to stand for 5-10 minutes or until thoroughly defrosted.
Sausage Rolls Large (cooked)	1-2 mins for 8 rolls, 375g (13oz) Total weight	3-4 mins	LOW (10%)	<ol style="list-style-type: none"> Place on a large plate. Turn over and re-arrange halfway through defrosting. After defrosting, cover with foil and leave to stand for 15-30 minutes or until thoroughly defrosted.
Quiche (cooked)	5-6 mins /450g (1lb)	7-8 mins	LOW (10%)	<ol style="list-style-type: none"> Place on a large plate. After defrosting, cover with foil and leave to stand for 15-30 minutes or until thoroughly defrosted.
Meat Pie (cooked)	4 mins /450g (1lb)	6-7 mins	LOW (10%)	As above.
Fruit Pie/Crumble (cooked)	3-4 mins /450g (1lb)	5-6 mins	LOW (10%)	As above.
Sponge Pudding (cooked)	2-3 mins /450g (1lb)	3-4 mins	LOW (10%)	As above.



DEFROSTING CHART

FOOD	DEFROSTING TIME		MICROWAVE POWER LEVEL	METHOD
	R-24AT	R-22AT		
Bread Sliced	2-3 mins /800g (1 ³ / ₄ lb) loaf	3-4 mins	MEDIUM LOW (30%)	<ol style="list-style-type: none"> 1. Arrange and separate slices on the turntable. 2. Turn over, separate and re-arrange twice during defrosting. Remove defrosted slices each time. 3. After defrosting, cover with foil for 5-10 minutes or until thoroughly defrosted.
Bread Buns	1-2 mins for 6 buns	2-3 mins	LOW (10%)	<ol style="list-style-type: none"> 1. Place on turntable. 2. Turn over & re-arrange halfway through defrosting. 3. After defrosting, cover with foil and leave to stand for 10-15 minutes or until thoroughly defrosted.
Rice (cooked)	3 ¹ / ₂ mins /450g (1lb)	4-5 mins	MEDIUM LOW (30%)	<ol style="list-style-type: none"> 1. Place in a large bowl. 2. Break up during defrosting, removing defrosted rice each time. 3. After defrosting, cover any frozen rice remaining with foil and leave to stand for 10-15 minutes or until thoroughly defrosted.

NOTES:

- Prior to defrosting, food is frozen approx. -18°C.
- If it is necessary to shield small areas of food, use small pieces of foil.
- Only use food which is thoroughly defrosted, use a professional food thermometer to ensure acceptable temperatures have been achieved throughout.

EXPRESS DEFROST

This is specially designed for smaller cuts of food. The following items are to be used on the express defrost programme.

1. Beef Steak
2. Lamb Chops
3. Pork Chops
4. Chicken Legs
5. Fish Fillets

The oven is pre-programmed with a time and power level cycle so that the food listed above is defrosted better and faster.

BASIC IDEAS FOR EXPRESS DEFROST

- i/ Always allow food to stand for approx. 30-45 minutes after defrosting to equalise the temperature and to produce better defrosting results.
- ii/ Check food after standing. If the item is not thoroughly defrosted, continue to defrost on 20% power for additional time.
- iii/ Choose foods that are the same thickness throughout. This will produce better defrosting results. Foods which vary in thickness may require shielding with small flat pieces of tin foil to prevent over-defrosting.
- iv/ For foods not listed in the chart refer to the manual defrosting chart.
- v/ When freezing chicken legs, steak, chops and fish, freeze separately in single flat layers and if necessary interleave with freezer plastic to separate layers. This will ensure even defrosting.

FOOD	METHOD	TIME PER 450g / 1lb	
		R-24AT	R-22AT
Steak Pork, lamb chops Chicken Legs	<ol style="list-style-type: none"> 1. Position the food with thinner parts in centre in a single layer, if pieces are stuck together separate as soon as possible. 2. Turn over, rearrange after the audible sound. After defrosting stand for 15-45 minutes. 	2 ¹ / ₂ mins	3 mins
Fish Fillets	<ol style="list-style-type: none"> 1. Position the food in a single layer. 2. Shield any thinner parts with foil if necessary. 3. If pieces are stuck together separate as soon as possible. 4. Turn over, rearrange after the audible sound. 5. After defrosting allow to stand for 15-45 mins. 	2 ¹ / ₂ mins	3 mins



C OOKING CHART

FOOD	COOKING TIME		MICROWAVE POWERLEVEL	METHOD
	R-24AT	R-22AT		
Beef: Medium (Topside, Silverside) Chilled (5°C)	7-8 mins	9-10 mins /450g (1lb)	MEDIUM HIGH (70%)	<ol style="list-style-type: none"> 1. Place fat side down in a flan dish. 2. Turn over halfway through cooking and remove juice. 3. After cooking, wrap in foil and leave to stand for 8 minutes before serving.
Lamb, medium (fillet, shoulder, leg) Chilled (5°C)	7-8 mins	9-10 mins /450g (1lb)	MEDIUM HIGH (70%)	As above.
Pork (loin, leg) Chilled (5°C)	7-8 mins	12-13 mins /450g (1lb)	MEDIUM HIGH (70%)	As above.
Poultry (whole) (max.3.5kg(8lb) Chilled (5°C)	5-6 mins	8-9 mins /450g (1lb)	MEDIUM HIGH (70%)	<ol style="list-style-type: none"> 1. Place breast side down in a flan dish. 2. Turn over halfway through cooking and remove juice. 3. After cooking, wrap in foil and leave to stand for 10 minutes before serving.
Chicken Portions Legs Breast Chilled (5°C)	4-5 mins 6-7 mins	5-6 mins 8-9 mins /450g (1lb)	MEDIUM HIGH (70%)	<ol style="list-style-type: none"> 1. Place best side down in a single layer in a flan dish. 2. Turn over halfway through cooking, & remove juice. 3. After cooking, wrap in foil and leave to stand for 5 minutes before serving.
Minced Beef Chilled (5°C)	4 mins	5 mins /450g (1lb)	MEDIUM HIGH (70%)	<ol style="list-style-type: none"> 1. Place in a large bowl. 2. Stir 2-3 times during cooking. 3. After cooking cover bowl with foil and leave to stand for 2-3 minutes before serving.
Bacon Chilled (5°C)	2 mins	3-4 mins for 8 rashers	HIGH (100%)	<ol style="list-style-type: none"> 1. Place in a single layer on a large plate. 2. Turn over halfway through cooking. 3. Leave to stand for 1 minute before serving.
Burgers (Thick) Chilled (5°C)	2 mins	4 mins for 4 burgers/450g(1lb)	HIGH (100%)	As above
Sausages (thick) Chilled (5°C)	2 mins	3 mins for 8 sausages	HIGH (100%)	As above
(thin) Chilled (5°C)	2 mins	3-4 mins for 12 sausages		
Sliced Gammon Chilled (5°C)	4 mins	5 mins for 1 slice/250g(9oz)	MEDIUM HIGH (70%)	As above



C OOKING CHART

FOOD	COOKING TIME		MICROWAVE POWERLEVEL	METHOD
	R-24AT	R-22AT		
Fish Fillet/ Steaks Chilled (5°C)	3 mins	4-5 mins /450g (1lb)	HIGH (100%)	<ol style="list-style-type: none"> Place in a single layer in a large flan dish, cover with microwave cling film and pierce in 4-5 places. Leave to stand for 2-3 minutes before serving.
Trout (whole) Chilled (5°C)	3 mins	4-5 mins /450g (1lb)	MEDIUM HIGH (70%)	As above.
Rice/Pasta Room (20°C)	6-7 mins	9-10 mins for 200g (70oz)	MEDIUM HIGH (70%)	<ol style="list-style-type: none"> Place Rice/Pasta in a 2.5 litre casserole dish. Add three times the volume of boiling water to quantity of rice. Do not cover. Stir 3 times during cooking. Stand for 2-3 minutes before rinsing in boiling water and serving.
Jacket Potatoes Room (20°C)	4-5 mins	6 mins for 2 potatoes	HIGH (100%)	<ol style="list-style-type: none"> Pierce each potato in several places. Place on the edge of the turntable. Stand for 3-4 minutes before serving.
Corn on the Cob Room 20°C Frozen -18°C	Fresh: 2-3 mins	4 mins for 2 cobs Frozen: 4-5 mins	HIGH (100%)	<ol style="list-style-type: none"> Place in a dish, add 60ml (4tbsp) water. Cover with microwave cling film pierce in 4-5 places. Turn over halfway through cooking. Stand for 1-2 minutes before serving.
Beans (green) Fresh: 20°C Frozen: -18°C	Fresh: 2 mins	3-4 mins for 225g (8oz) Frozen: 2-3 mins	HIGH (100%)	<ol style="list-style-type: none"> Place in a dish, add 30ml (2tbsp) water. Cover with microwave cling film and pierce in 4-5 places. Stir halfway through cooking. Stand for 1-2 minutes before serving.
Broccoli Fresh: 20°C Frozen: -18°C	Fresh: 2 mins	3-4 mins for 225g (8oz) Frozen: 3 mins	HIGH (100%)	As above
Carrots (sliced) Fresh: 20°C Frozen: -18°C	Fresh: 2 mins	4 mins for 225g (8oz) Frozen: 3 mins	HIGH (100%)	As above
Carrots (baby, whole) Fresh: 20°C Frozen: -18°C	Fresh: 2 mins	4 mins for 225g (8oz) Frozen: 3 mins	HIGH (100%)	As above
Cauliflower Fresh: 20°C Frozen: -18°C	Fresh: 2 mins	3-4 mins for 225g (8oz) Frozen: 3 mins	HIGH (100%)	As above



C OOKING CHART

FOOD	COOKING TIME		MICROWAVE POWERLEVEL	METHOD
	R-24AT	R-22AT		
Peas <i>Fresh: 20°C</i> <i>Frozen: -18°C</i>	Fresh: 1-2 mins for 225g (8oz)	2-3 mins for 225g (8oz)	HIGH (100%)	<ol style="list-style-type: none"> Place in a dish, add 30ml (2tbsp) water. Cover with microwave cling film and pierce in 4-5 places. Stir halfway through cooking. Leave to stand for 1-2 minutes before serving.
New potatoes <i>Room 20°C</i>	4 mins	6-7 mins for 450g (1lb)	HIGH (100%)	<ol style="list-style-type: none"> Place in a large dish, add 60ml (4tbsp) water. Cover dish with microwave cling film and pierce in 4-5 places. Stir halfway through cooking. Leave to stand for 1-2 minutes before serving.
Mushrooms (fresh) <i>Room 20°C</i>	1 min	2 mins for 225g (8oz)	MEDIUM HIGH (70%)	<ol style="list-style-type: none"> Chop or leave whole as desired. Place in dish, cover with microwave cling film and pierce in 4-5 places. Stir halfway through cooking.
Tomatoes (fresh) <i>Room 20°C</i>	1 min	2 mins for 225g (8oz)	MEDIUM HIGH (70%)	<ol style="list-style-type: none"> Slice or quarter as desired. NOTE: If you wish to leave whole, pierce in several places. Place in a dish or on a plate, cover with microwave cling film and pierce in 4-5 places. Leave to stand for 1-2 minutes before serving.
Scrambled Egg <i>Chilled 5°C</i>	2 mins	3 mins	HIGH (100%)	<ol style="list-style-type: none"> Place 6 eggs (size 3), 150ml ($\frac{1}{4}$ pint) milk, 15g ($\frac{1}{2}$oz) butter, salt and pepper in a bowl and beat thoroughly until smooth. Beat 3 times during cooking until desirably set. Leave to stand for 30 seconds before serving.

NOTES

- Only serve food which is thoroughly cooked, use a professional food thermometer to ensure acceptable temperatures have been reached throughout.
- Hygiene - see Food Handling & Preparation, Page 15
- When cooking joints of meat small pieces of aluminium foil can be used to shield small areas of meat if they start to overcook.
- During standing time food should be covered. If covered during cooking, leave covered. If cooked uncovered, cover with foil.
- The cooking times given above are provided as a guide only. Cooking times will vary according to food weight, quality and initial temperature. Please ensure that food is thoroughly cooked before serving.



R EHEATING CHART

FOOD	TEMP	QUANTITY	METHOD	REHEATING TIME ON HIGH (100%)	
				R-24AT	R-22AT
BREAKFAST					
Porridge	Chilled	125g (5oz)	Place in a bowl, uncovered	35 sec	1 min
Scrambled Egg	Chilled	125g (5oz)	Place on a plate, uncovered	30 sec	50 sec
Scrambled Egg with bacon or sausage	Chilled	175g (6oz)	As above	50 sec	1 min 20 sec
Bacon	Chilled	4 rashers	As above	25 sec	45 sec
Sausages - thick	Chilled	4	As above	35 sec	55 sec
Sausages-thin	Chilled	8	As above	35 sec	55 sec
Smoked Haddock	Chilled	175g (6oz)	As above	45 sec	1 min 20 sec
Mushrooms	Chilled	100g (4oz)	Place in a bowl, uncovered	15 sec	30 sec
Fresh Tomatoes	Chilled	100g (4oz)	As above	15 sec	30 sec
HOT SANDWICHES					
Chickenburger	Chilled	135g (5oz)	Place on a plate, uncovered	35 sec	45 sec
Hamburger	Chilled	125g (5oz)	Place on a plate, uncovered	35 sec	45 sec
Cheeseburger	Chilled	175g (6oz)	As above	35 sec	45 sec
Hot Dog	Chilled	175g (6oz)	As above	35 sec	50 sec
Bacon	Chilled	175g (6oz)	As above	35 sec	50 sec
Sausage	Chilled	225g (8oz)	As above	50 sec	55 sec
Beef	Chilled	175g (6oz)	As above	35 sec	45 sec
PREPARED DISHES					
Lasagne	Chilled	300g (11oz)	1. Place on a plate, cover with cling film 2. Stand covered for 2-3 minutes	2 mins 15 sec	3 mins
Chilli con Carne & Rice	Chilled	325g (12oz)	As above	2 mins	3 mins
Curry & Rice	Chilled	300g (11oz)	As above	2 mins	3 mins
Shepherds Pie	Chilled	300g (11oz)	As above	1 min 15 sec	2 mins
Stew & Dumplings	Chilled	400g (14oz)	As above	2 mins 30 sec	3 mins



R EHEATING CHART

FOOD	TEMP	QUANTITY	METHOD	REHEATING TIME ON HIGH (100%)	
				R-24AT	R-22AT
PREPARED DISHES					
Bangers & Mash	Chilled	325g (12oz)	Place on a plate, cover with cling film	1 min 15 sec	2 mins 15 sec
Duck à l'orange	Chilled	540g (1lb 4oz)	As above	3 mins 15 sec	4 mins
Spaghetti Bolognese	Chilled	300g (11oz)	As above	1 min 15 sec	2 mins 15 sec
Chicken in a sauce	Chilled	300g (11oz)	As above	2 mins 30 sec	3 mins 15 sec
Beef Stroganoff & Rice	Chilled	375g (13oz)	As above	2 mins 30 sec	2 mins 40 sec
BBQ Ribs	Chilled	375g (13oz)	As above	2 mins	3 mins
Rice/Pasta	Chilled	225g (8oz)	As above	45 sec	1 min 30 sec
SAVOURY BREAD AND PASTRY					
Dinner Roll(s)	Chilled	1	Place on the turntable, uncovered	5 sec	10 sec
		2	As above	10 sec	20 sec
Croissant(s)	Chilled	1	As above	4 sec	9 sec
		2	As above	6 sec	11 sec
Garlic Bread	Chilled	250g (9oz)	As above	20 sec	40 sec
Pizza Slice	Chilled	125g (5oz)	Place on a plate, uncovered	25 sec	40 sec
	Frozen	100g (4oz)	As above	50 sec	1 min 5 sec
Pizza - small	Chilled	75g (3oz)	As above	15 sec	30 sec
	Frozen	100g (4oz)	As above	50 sec	1 min 5 sec
Pizza - large	Chilled	400g (14oz)	As above	1 min	1 min 30 sec
	Frozen	400g (14oz)	As above	2 mins	3 mins 40 sec
Meat Pie - small	Chilled	125g (5oz)	1. Place on a plate, uncovered 2. Stand for 2-3 minutes	30 sec	50 sec
Meat Pie - large	Chilled	450g (1lb)	1. Place on a plate, uncovered 2. Stand for 3-4 minutes	1 min 10 sec	1 min 50 sec
Quiche - slice	Chilled	125g (5oz)	1. Place on a plate, uncovered 2. Stand for 2-3 minutes	30 sec	30 sec
Quiche - whole	Chilled	540g (1lb 4oz)	1. Place on a plate, uncovered 2. Stand for 3-4 minutes	1 min 30 sec	2 mins



R EHEATING CHART

FOOD	TEMP	QUANTITY	METHOD	REHEATING TIME ON HIGH (100%)	
				R-24AT	R-22AT
SAVOURY BREAD AND PASTRY					
Cornish Pastie(s) (175g)(6oz) each	Chilled	1	Place on a plate, uncovered	35 sec	55 sec
		2	As above	1 min 10 sec	1 min 50 sec
Sausage Roll(s) 75g (3oz) each	Chilled	1	Place on a plate, uncovered	15 sec	30 sec
		2	As above	25 sec	40 sec
CANNED FOODS					
Baked Beans	Room	450g (1lb)	Place in a bowl, cover with cling film, stir halfway through cooking	1 min 30 sec	2 mins 10 sec
Sausage & Beans	Room	450g (1lb)	As above	2 mins 10 sec	3 mins
Soup - thick/thin	Room	425g (15oz)	As above	1 min 50 sec	2 mins 30 sec
Hot Dogs	Room	425g (15oz)	Place in a bowl, cover with cling film	1 min 45 sec	2 mins 30 sec
Peas	Room	550g (1lb 4oz)	Place in a bowl, cover with cling film, stir halfway through cooking	2 mins 10 sec	3 mins
Sweetcorn	Room	325g (12oz)	As above	1 min 30 sec	2 mins
Carrots - whole, sliced	Room	540g (1lb 4oz)	As above	2 mins 30 sec	3 mins 20 sec
Tomatoes	Room	400g (14oz)	As above	2 mins 30 sec	3 mins
Asparagus	Room	350g (12oz)	As above	1 min 50 sec	2 mins 30 sec
Green Beans	Room	300g (11oz)	Place in a bowl, cover with cling film, stir halfway through cooking	2 mins 30 sec	3 mins
FRESH VEGETABLES					
Green Beans	Chilled	125g (5oz)	Place on a plate, uncovered	30 sec	40 sec
Broccoli	Chilled	125g (5oz)	Place on a plate, uncovered	30 sec	40 sec
Carrots - sliced	Chilled	125g (5oz)	Place on a plate, uncovered	30 sec	40 sec
Cauliflower	Chilled	125g (5oz)	Place on a plate, uncovered	30 sec	40 sec
Corn on the Cob	Chilled	200g (7oz)	Place on a plate, uncovered	1 min 10 sec	1 min 45 sec
Peas	Chilled	100g (4oz)	Place on a plate, uncovered	30 sec	45 sec



R EHEATING CHART

FOOD	TEMP	QUANTITY	METHOD	REHEATING TIME ON HIGH (100%)	
				R-24AT	R-22AT
FRESH VEGETABLES					
Jacket Potatoes	Chilled	250g (9oz)	Place on the turntable, uncovered	1 min	1 min 45 sec
New Potatoes	Chilled	225g (8oz)	Place on a plate, uncovered	1 min	1 min 45 sec
Brussels Sprouts	Chilled	225g (8oz)	Place on a plate, uncovered	30 sec	40 sec
MEAT PORTIONS					
Chicken Portions Leg Breast	Chilled	1 (300g)(11oz)	Place on a plate, cover with cling film	1 min	1 min 30 sec
	Chilled	1 (400g)(14oz)	Place on a plate, cover with cling film	1 min 30 sec	2 mins
Lamb Chops	Chilled	3 (225g)(8oz)	Place on a plate, cover with cling film	1 min 30 sec	2 mins
Pork Chop	Chilled	1 (125g)(5oz)	Place on a plate, cover with cling film	50 sec	1 min 30 sec
Sliced Meat with Gravy	Chilled	1 (225g)(8oz)	Place on a plate, cover with cling film	1 min 30 sec	2 mins 10 sec
Gammon-sliced	Chilled	1(250g)(9oz)	Place on a plate, cover with cling film	55 sec	1 min 20 sec
Trout	Chilled	1(200g)(7oz)	Place on a plate, cover with cling film	1 min	1 min 30 sec
Salmon Steak	Chilled	1(200g)(7oz)	Place on a plate, cover with cling film	1 min	1 min 30 sec



R EHEATING CHART

FOOD	TEMP	QUANTITY	METHOD	REHEATING TIME ON HIGH (100%)	
				R-24AT	R-22AT
SWEET PORTIONS					
Fruit Crumble	Chilled	175g (6oz)	Place in a bowl, uncovered	35 sec	45 sec
Fruit Crumble with custard	Chilled	275g (10oz)	Place in a bowl, uncovered	1 min	1 min 30 sec
Fruit Pie	Chilled	175g (6oz)	Place in a bowl, uncovered	35 sec	45 sec
Fruit Pie with Custard	Chilled	275g (10oz)	Place in a bowl, uncovered	50 sec	1 min
Sponge Pudding	Chilled	125g (5oz)	Place in a bowl, uncovered	20 sec	35 sec
Sponge Pudding with Custard	Chilled	225g (8oz)	Place in a bowl, uncovered	45 sec	1 min 10 sec
Suet Pudding	Chilled	175g (6oz)	Place in a bowl, uncovered	20 sec	35 sec
Suet Pudding with Custard	Chilled	275g (10oz)	Place in a bowl, uncovered	45 sec	1 min 10 sec
Chocolate Fudge Cake	Chilled	125g (5oz)	Place on a plate, uncovered	15 sec	30 sec

NOTES

- Only serve food which is thoroughly reheated, use a professional food thermometer to ensure acceptable temperatures have been reached throughout.
- Temperatures referred to in this chart are: *Room*, approx. 20°C, *Chilled*, approx. 5°C, and *Frozen*, approx. -18°C
- Hygiene - see Food Handling & Preparation, Page 15
- During standing time (where recommended) food should be covered. If covered during reheating, leave covered. If reheated uncovered, cover with foil.
- The reheating times given above are provided as a guide only. Reheating times will vary according to food weight, quality and initial temperature. Please ensure that food is thoroughly reheated before serving.



C LEANING & MAINTENANCE

WARNING

- Do not allow grease or dirt to build up on the door seals and adjacent parts as this may prevent the door from closing correctly and may cause a leakage of microwaves. To clean use a mild detergent solution on a soft damp cloth.
- DO NOT OPERATE the oven without the splash cover in place.
- DO NOT REMOVE the splash cover UNLESS THE POWER CORD IS REMOVED FROM THE OUTLET because the rotary antenna, which is located on the ceiling, operates for 1 minute after the door is opened and injury could occur.
- Keep the ceramic floor clean at all times. If you leave grease or fat in the cavity, it may overheat, smoke or even catch fire when next using the oven.
- Never use spray cleaners, oven pads or abrasive scourers as these damage the surface of the oven.
- Do not remove the ceramic floor from the oven.
- Do not use commercial oven cleaners, abrasive or harsh cleaners or scouring pads on any part of your microwave oven.
- Do not sprinkle water onto the oven directly. It may cause electric shock, leakage of electricity or damage of the oven.

OVEN INTERIOR

Clean the microwave oven cavity, at the end of each day with a damp soft cloth for hygienic reasons. For heavier soil, use mild soap applied with a soft damp cloth wipe clean ensuring all soap is removed. Make sure that the soap or water does not penetrate through the small vents in the walls which may cause damage to the oven. Take

care not to let soapy water drip through the small holes in the oven walls. Excess water spillage through these holes will cause damage to the oven interior. It is important that the door seals and sealing surfaces are kept clean at all times, wipe regularly with a damp cloth.

The ceramic floor should be kept clean at all times. Minor spills may be wiped with a damp cloth.

SPLASH COVER

AT LEAST ONCE A WEEK, REMOVE THE SPLASH COVER AND WASH BOTH SIDES OF IT IN A MILD DETERGENT SOLUTION. A BUILD UP OF GREASE MAY OVERHEAT AND BEGIN TO SMOKE AND MAY BURN THE SPLASH COVER. THE SPLASH COVER IS LOCATED IN THE TOP OF THE OVEN AND MAY EASILY BE REMOVED. REMEMBER TO UNPLUG THE POWER CORD.

Removal:

- Remove two thumb screws (A) as shown in Fig.1.
- Remove the splash cover from the oven.

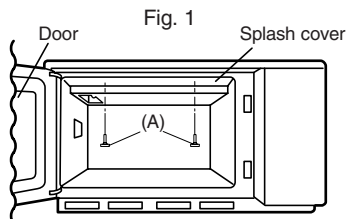

Reinstall:

- Insert two projections of the cover (B) into the holes of the oven cavity backplate as shown in Fig. 2.
- Secure the cover to the oven ceiling with two thumb screws (A) as shown in Fig. 1.

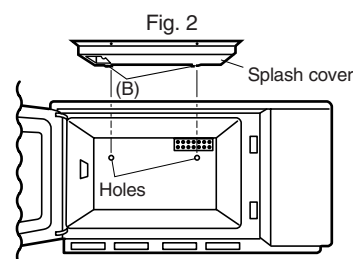

OUTER CABINET

Wipe the outside cabinet with a mild detergent solution on a soft cloth. The control panel must be wiped clean whilst the door is open, therefore inactivating the oven. Keep the air intake filter clean. Clean the air intake filter once every two weeks.

Remove the air intake filter by pulling the two (2) clips on the sides of the filter.

Wash the air intake filter in mild soapy water, rinse and dry with a soft cloth.

After cleaning re-install the air intake filter.

Do not operate the oven without the air intake filter in place.

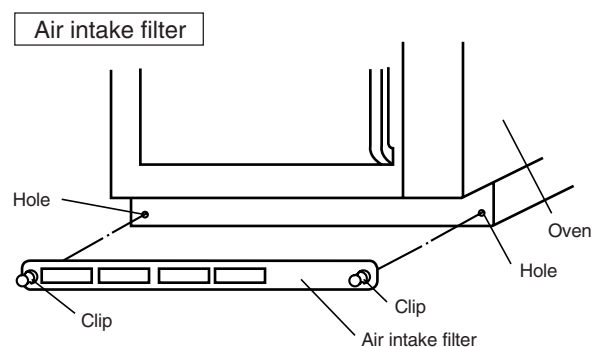



TROUBLESHOOTING

If you think the oven is not working properly there are some simple checks which you can carry out yourself before you call for an engineer. This will help prevent unnecessary service calls if the fault is something simple.

Simply answer "YES" or "NO" to the following questions:

- 1 Do the oven lamp and fan motor come on for 1 minute when you open the door? **YES/NO**

Put half a cup of water on the ceramic floor in the oven and close the door. Cook for 1 minute at 100%.

- 2 Does the oven lamp come on? **YES/NO**
 3 Does the fan motor work? (Check by placing your hand above the air vent openings) **YES/NO**
 4 After 1 minute does the "Beep" signal sound? **YES/NO**
 5 And did the heating indicator "ON" go out? **YES/NO**
 6 Is the water in the cup hot? **YES/NO**

If you answer "NO" to any question first check that the oven is plugged in properly and the fuse has not blown, if there is no fault with either, check against the troubleshooting chart below.

⚠ WARNINGS:

• **Never adjust, repair or modify the oven yourself, or allow anyone other than a Service Technician, appointed by SHARP to carry out the service.**

- The door seal stops microwave leakage during oven operation, but does not form an airtight seal. It is normal to see drops of water, light or feel warm air around the oven door. Food with a high moisture content will release steam and cause condensation inside the door which may drip from the oven.
- Repairs & Modifications: Do not attempt to operate the oven if it is not working properly.
- Outer Cabinet & Lamp Access: Never remove the outer cabinet. This would be very dangerous due to high voltage parts inside which must **never** be touched, as this could be fatal, As your oven has a removable cover over oven light bulb, it is possible for you to replace the light bulb yourself with care. The light bulb can be purchased from Sharp Electronics (U.K.) Ltd. See page 30. Unplug the oven before replacing the light bulb.

PROBLEM	POSSIBLE CAUSE
Draught circulates around the door.	When oven is working, air circulates within the cavity. The door does not form an airtight seal so air may escape from the door.
Condensation forms in the oven, and may drip from the door.	The oven cavity will normally be colder than the food being cooked, and so steam produced when cooking will condense on the colder surface. The amount of steam produced depends on the water content of the food being cooked. Some foods, such as potatoes have a high moisture content. Condensation trapped in the door glass should clear after a few hours.
Flashing or arcing from within the cavity when cooking.	Arcing will occur when a metallic object comes into close proximity to the oven cavity during cooking. This may possibly roughen the surface of the cavity, but would not otherwise damage the oven.
Arcing potatoes.	Ensure all "eyes" are removed and place in a heat resistant flan dish or similar.
After setting the time, the oven does not start.	Check the door is closed properly.
Oven cooks too slowly.	Ensure correct power level has been selected.
Oven makes a noise.	The microwave energy pulses ON/OFF during cooking/defrosting.
Outer cabinet is hot.	The cabinet may become warm to the touch - keep children away



T O REPLACE THE MAINS PLUG

The wires in the mains cable are colour coded as shown opposite:

As the colours of the cores in the mains lead of your oven may not correspond with the coloured marking identifying the terminals in your plug, connect the wires as shown:

Make sure the terminal screws are tight and the cable is held securely by the cable grip where it enters the plug. Like most appliances in your home, your oven must be connected to a single phase 230-240 Volt, 50Hz alternating current supply.

If you do not make the proper electrical connections you might damage the oven or injure yourself. Neither SHARP nor the supplier will be liable if this happens.

green and yellow stripes = **EARTH**
 blue = **NEUTRAL**
 brown = **LIVE**

- The green and yellow wire to the plug terminal marked E or \equiv or coloured green or coloured green and yellow.
- The blue wire to the plug terminal marked N or coloured black or coloured blue.
- The brown wire to the plug terminal marked L or coloured red or coloured brown.

⚠ WARNING:

**THIS APPLIANCE MUST BE EARTHED.
 IF YOU HAVE ANY DOUBTS ABOUT YOUR
 ELECTRICAL SUPPLY ASK A QUALIFIED
 ELECTRICIAN.**

C ALLING FOR SERVICE

- If you are unable to resolve a problem using the checks covered on the last few pages, **do not attempt to service this microwave oven yourself.**
- Contact the dealer or supplier from whom the oven was purchased in order to obtain service. Where this is not possible, please contact the SHARP Customer Information Centre, telephone: 08705 274277 (office hours).
- For general information & assistance with oven queries, please contact our
Customer Information Centre:
U.K.: 08705 274277 (office hours)
Ireland: 01 676 0648 (office hours)
Website: <http://www.sharp.co.uk/support>
- Replacement accessories may be obtained from our main parts distributor Willow Vale Electronics Ltd. Telephone: 0121 766 5414



SPECIFICATIONS:

AC Line voltage	Single phase 230-240V, 50Hz
AC Power required	R-24AT : 2.9kW R-22AT : 2.4kW
Output power	R-24AT : 1900W (IEC 60705) R-22AT : 1500W (IEC 60705)
Microwave frequency	2450MHz* (Class B/Group 2)
Outside dimensions	510(W) x 335(H) x 470(D) mm (Single) 510(W) x 670(H) x 470(D) mm (Two ovens stacked)
Cavity dimensions	330(W) x 180(H) x 330(D) mm
Oven capacity	0.7 cu.ft (20 litres)
Cooking uniformity	Rotary antenna system
Weight	Approx. 33kg

* This is the classification of ISM (Industrial Scientific and Medical) equipment described in the International Standard CISPR 11.



- This oven complies with the requirements of Directives 89/336/EEC and 73/23/EEC as amended by 93/68/EEC.
- As part of a policy of continuous improvement, we reserve the right to alter design and specification without notice.
- No part of this publication may be reproduced, stored in a retrieval system or transmitted in any form, electronic, mechanical, photocopied, recorded, translated or other means without prior permission from SHARP Electronics (U.K.) Ltd.
- The illustrations, technical information and data contained in this publication to our best knowledge, were correct at the time of going to print. The right to change specifications, at any time, without notice, is reserved as part of our policy of continuous development and improvement.

SHARP

SHARP ELECTRONICS (U.K.) Ltd

Manchester, U.K.

U.K.: 08705 274277 (office hours)

Ireland: 01 676 0648 (office hours)

Website: <http://www.sharp.co.uk/support>

Printed with soy ink
recycled paper

Printed in Japan.

TINSEA821WRR0-K24