



DF618 - Silverlink 600 Electric Counter-top Twin Tank Fryer - 2 Baskets - W 600 mm - 2 x 9.0 kW

The Silverlink 600 Electric Twin Tank Counter Top Fryer not only provides greater versatility, but also increased power capable of delivering 60kg of chips per hour.

- ✓ Two independently operated fryer tanks for greater versatility, increased power delivers 60kg of chips per hour
- ✓ Front mounted controls for safety
- ✓ Hinged elements to give easy access during cleaning
- ✓ Cool zone collects cooking debris - gives cleaner cooking results and saves money by prolonging the life of the oil
- ✓ Thermostatically controlled to give accurate cooking temperatures throughout cooking. Fail-safe top temperature cut out ensures safe operation.
- ✓ Fully moulded 304 stainless steel tank and heavy duty nickel plated baskets for the most demanding of operations
- ✓ Front drain off tap for easy removal of cooking oil

Specifications

Summary

Range Name	Silverlink 600
Power Type	Electric
Unit Type	Counter-top
Available in UK Only	No
UK Warranty	2 Years Parts and Labour Warranty
Export Warranty	Contact your local dealer
GTIN Code	5056105104650

Power and Performance

Total Power kW	2 x 9.0
Temperature Range °C	130 - 190
IP Rating	IP33
Temperature Control	Mechanical

Key Specifications

Capacity Litres	2 x 9.0
Number of Baskets	2
Number of Tanks	2
Gravity Filtration	No
Pumped Filtration	No
Drain Location	Front-mounted

Weights and Dimensions

Unit Height (External) mm	330
Unit Width (External) mm	600
Unit Depth (External) mm	632
Net Weight Kg	27

Supply Connections

Requires Installation	Yes
Requires Electrical Supply	Yes
UK 3 Pin Plug	No
Requires Hardwiring	Yes
Electrical Supply Rating Watts	2 x 9,000
Single Phase Amps	2 x 39.0
Single Phase Voltage	230
Three Phase Amps	L1=2 x 13.0 ; L2=2 x 13.0 ; L3=2 x 13.0
Three Phase Voltage	400

Shipping

Packed Weight Kg	33
Packed Height cm	49.5
Packed Width cm	70
Packed Depth cm	70

Available Accessories

BA96	BASKET SPUN DFSMALL
CC6	Silverlink 600 Free-standing Ambient Open-Top Pedestal with Doors - W 600 mm
CN6	Silverlink 600 Free-standing Ambient Open-Top Pedestal without Doors - W 600 mm
HC6	Silverlink 600 Free-standing Heated Open-Top Pedestal with Doors - W 600 mm - 0.5 kW

Available Accessories

- HCL6** Silverlink 600 Free-standing Heated Pedestal with Legs and Doors - W 600 mm - 0.5 kW
- SLS6** Silverlink 600 Free-standing Floor Stand - for units W 600 mm

Technical Picture

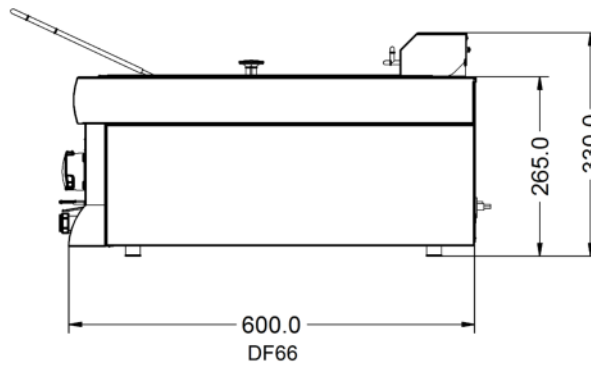
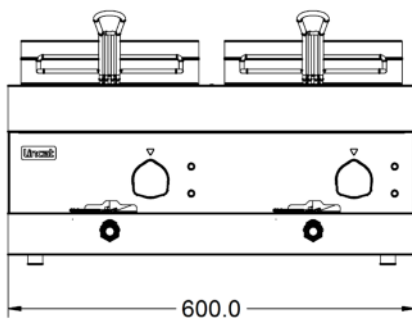
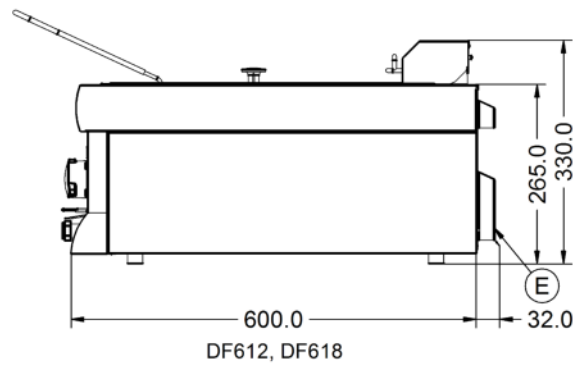
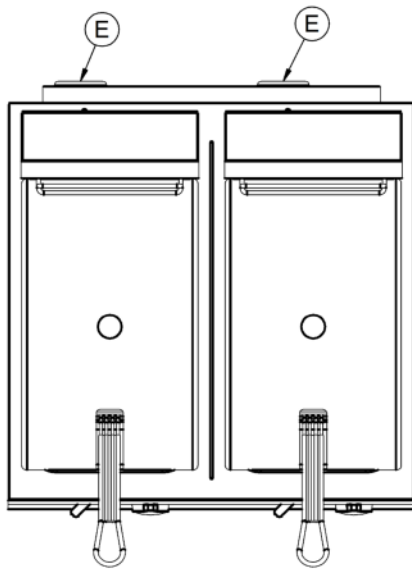



Lincat Limited

Whisby Road,
Lincoln, LN6 3QZ,
United Kingdom

Company No: 2175448

A member company of



Customer Care

Tel: +44 1522 875500
Email: care@lincat.co.uk

Export Customers

Tel: +44 1522 503250
Email: export@lincat.co.uk

Opening Hours

Monday – Friday:
8.30am – 5pm