

Instruction manual

Chamber machine P300

MCB01



Serial number:

.....

Service address:

Manufacturer:

MULTIVAC
Sepp Haggenmüller GmbH & Co. KG
Bahnhofstraße 4
D-87787 Wolfertschwenden, Germany
Tel.: 0049 8334 601 0

www.multivac.com

Date: 11.06.2014

The reproduction, distribution and utilization of this document as well as the communication of its contents to others without express authorization is prohibited. Offenders will be held liable for the payment of damages. All rights reserved in the event of the grant of a patent, utility model or design.

Contents

Important information on the manual	5
Machine documentation	5
Changes not covered in the manual	5
Symbols used	6
1 Safety.....	8
1.1 General safety instructions.....	8
1.1.1 Target group.....	8
1.1.2 Unauthorised modifications and manufacture of spare parts.....	10
1.2 EC Conformity.....	11
1.3 Intended use	11
1.3.1 Electromagnetic compatibility (EMC)	12
1.3.2 Non-ionising radiation	12
1.4 Reasonably foreseeable incorrect use.....	12
1.5 Warning against incorrect use.....	12
1.6 Residual risks.....	13
1.7 Obligations of the operating company.....	13
1.7.1 Creating the operating directive	13
1.7.2 Monitoring obligation.....	13
1.7.3 Making the selection of personnel.....	14
1.7.4 Training the personnel	14
1.7.5 Providing personal protective equipment.....	14
1.7.6 Avoiding hazards.....	14
1.7.7 Providing the installation location.....	14
1.7.8 Provide power supply.....	15
1.7.9 Observe the requirements for the gas supply	15
1.7.10 Avoiding hygiene risks	16
1.7.11 Checking the packs.....	17
1.7.12 Pump protection function	18
1.7.13 Testing pressure equipment.....	18
1.8 Danger zones.....	18
1.8.1 Chamber lid.....	20
1.8.2 Vacuum pump.....	20
1.8.3 Electrical system	20
1.9 Safety devices.....	20
1.10 Machine labelling	20
2 Description.....	22
2.1 Construction of the machine	22
2.2 Optional equipment.....	22
2.2.1 Gas flushing system.....	22

2.3	Control terminal.....	23
2.4	Display	24
2.5	Process sequence.....	25
2.6	Times which have to be set.....	26
2.7	Technical specifications	27
3	Start-up.....	31
3.1	Setting up the machine and starting it up.....	31
4	Operation	41
4.1	Opening and closing the chamber lid.....	41
4.2	Switching on the machine	42
4.3	Switching off the machine	42
4.4	Setting the times	43
4.5	Packing products.....	43
4.6	Aborting evacuation	46
4.7	Aborting packaging procedure	46
4.8	Working with recipes	47
4.8.1	Load recipe	47
4.8.2	Save recipe	47
4.9	Perform pump protection function	47
5	Adjustment work and setup	49
5.1	Insert and remove the sloping insert	49
6	Cleaning	50
6.1	Notes on cleaning	50
6.1.1	Instructions for creating company cleaning guidelines.....	50
6.1.2	Instructions for maintaining the machine's value	51
6.1.3	Instructions on the handling of cleansers.....	52
6.1.4	Instructions on the handling of disinfectants	52
6.1.5	Instructions on the handling of anti-corrosion agents and lubricants	53
6.1.6	Instructions on the handling of cleaning devices.....	53
6.2	Cleaning recommendations	53
6.3	Care products table.....	56
7	Maintenance.....	59
7.1	Maintenance schedule	59
7.2	Service recommendation	60
7.2.1	Vacuum pump - Perform the pump protection function.....	60
7.2.2	Entire machine - Visual inspection.....	60
7.2.3	Entire machine - Alkaline cleaning and disinfection	61
7.2.4	Entire machine - Perform a wipe test.....	61
7.2.5	Entire machine - Acidic cleaning and disinfection	61
7.2.6	Connections - Visual inspection	61
7.2.7	Vacuum pump - Checking oil level, topping up	61
7.2.8	Vacuum pump - Oil change.....	62
7.2.9	Vacuum pump - Exchanging the air de-oiling element.....	62
7.2.10	Entire machine - Check the age.....	62

7.3	Replace the sealing bar	62
7.3.1	Remove the sealing bar	62
7.3.2	Install the sealing bar	63
7.4	Repair counter-pressure bar	63
7.5	Open and close the housing	65
7.5.1	Open housing	65
7.5.2	Close housing	67
7.6	Change the oil in the vacuum pump.....	68
7.6.1	Drain oil	68
7.6.2	Filling the vacuum pump with oil.	70
7.7	Change the air de-oiling element	72
7.8	Change chamber lid gasket	74
7.9	Check the chamber for leaks	75
8	Troubleshooting	77
8.1	Faults with diagnostic message	77
8.2	Faults without diagnostic message	77
9	Shutdown, transport, storage	80
9.1	Shutting down the machine.....	80
9.2	Transporting the machine	80
9.2.1	Transporting the machine	80
9.3	Storing the machine	81
10	Disposal	82
10.1	Disposing of the machine.....	82
10.2	Dispose of operating materials.....	82
10.2.1	Disposing of oil and grease.....	82
10.2.2	Disposing of packaging materials	83
10.2.3	Dispose of chemicals	83
11	Spare parts.....	85
	MULTIVAC branch offices.....	87

Important information on the manual

Read the manual carefully before you begin working with the machine.

- This manual is an integral component of the unit. Keep the manual for future reference.
- Do not work with the machine until you have read through the manual and completely understood its contents.
- Please contact MULTIVAC as soon as possible if there is something you do not understand in the manual! Your comments will help us to further improve the manual.
- Do not start up the machine if there are any visible defects!
- Only trained persons are permitted to install, operate and service the machine. The operating company is responsible for the qualifications and training of operating personnel.
- If you sell, transfer ownership or lend the machine to others, you must provide the manual along with it!

For reasons of clarity, some illustrations show the machine without the prescribed safety devices. Operating the machine without the safety devices is prohibited.



Injury hazard!

Altered, damaged, defective or incorrectly applied or missing safety devices will render the danger zones unprotected.

Unprotected danger zones can cause serious or even fatal injuries.

- Do NOT alter the safety devices.
- Use only MULTIVAC spare parts and accessories.
Before switching on the machine each time:
 - Check that all safety guards close completely and prevent reaching into the danger zones.
 - Check that only those safety devices are used which are suitable for the machine equipment.
 - Check that all safety devices are functional and in a technically flawless condition.

Machine documentation

- Instruction manual.
- EU Declaration of Conformity



Info

The complete scope of delivery is listed in the order confirmation.

Changes not covered in the manual

Continuous development is the foundation for ensuring that our machines are technically advanced and of high quality. For this reason,

you may discover slight deviations between the specifications in the manual and your machine. We also cannot rule out errors. The specifications, figures and descriptions in this manual do not constitute a legal contract between the manufacturer and customer.

Symbols used

Warnings draw your attention to hazards. Warnings are displayed in the following form:



Danger from electrical shock!

Used to indicate that serious danger of electrical shock is imminent. Ignoring this danger can cause serious or even fatal injuries.

- Observe the notices for avoiding danger.



Immediate danger!

Used to indicate that serious danger is imminent. Ignoring this danger can cause serious or even fatal injuries.

- Observe the notices for avoiding danger.



Dangerous situations!

Used to indicate dangerous situations. Non-observance can cause serious or even fatal injuries.

- Observe the notices for avoiding danger.



Potentially dangerous situations!

Used to indicate potentially dangerous situations. Ignoring this danger can cause injuries.

- Observe the notices for avoiding danger.

NOTICE Danger of material damage!

Used to indicate potentially dangerous situations. Ignoring these situations can cause material damage.

- Observe the notices for avoiding danger.

Information that contributes to a better understanding of how the machine functions is shown in the following form:



Info

Indicates information on special features deserving your attention.

Instructions to follow are displayed in the following form:

- Press key A.
- Release screw B.

➤ Press key C.

- Enumerated items are marked with bullet points.
 - Dashes are used to mark sub-items of enumerated lists or sequences of steps to be taken.

1 Safety

1.1 General safety instructions

The machine incorporates the latest technological principles. Nevertheless, potential hazards for persons, the machine and other materials cannot be entirely excluded.

- Before you start up the machine, read through the instruction manual and follow the instructions contained therein.
- Keep the instruction manual near the machine for future reference.
- Observe the safety and accident prevention regulations valid in your country.

1.1.1 Target group

The persons, who work with or at the machine, must have as a minimum requirement the following capabilities, knowledge and competence:

- The persons are authorized by the company operating the machine to carry out those tasks, which they perform with or at the machine.
- The persons are at least 14 years old.
- The persons know the danger zones of the machine and the accident prevention regulations.
- The persons know how they should behave in an emergency situation.
- The persons have been given instruction about the machine and are familiar with the handling of it.
- The persons have read and understood the operating directive.
- The persons have read and understood the instruction manual of the machine.
- The persons have been informed about the possible hygiene risks.

The persons, who put the machine into service, or adjust and set it up, or who are responsible for maintenance work and eliminating faults, must have the following capabilities, knowledge and competence:

- Due to their professional training, knowledge and experience, as well as their familiarity with the relevant regulations, the persons are able to assess the tasks assigned to them and to recognize potential hazards.
- The persons can read and interpret technical texts and technical drawings or plans.
- The persons are familiar with the handling of computer-controlled machines.
- The persons can install components and modules for technically complex systems.

- The persons can ensure that the machine remains capable of operation.
- The persons can perform maintenance work and inspections.

The persons, who carry out work on electrical components, must have as a minimum requirement the following capabilities, knowledge and competence:

- Due to their professional training, knowledge and experience, as well as their familiarity with the relevant regulations, the persons are able to assess the tasks assigned to them and to recognize potential hazards.
- The persons have been trained as qualified electricians and are able to prove this.
- The persons have up-to-date knowledge and experience in the electrical area, and they have actively practised these skills in recent years.

The persons, who carry out work on gas supplies, must have as a minimum requirement the following capabilities, knowledge and competence:

- Due to their professional training, knowledge and experience, as well as their familiarity with the relevant regulations, the persons are able to assess the tasks assigned to them and to recognize potential hazards.
- The persons have been trained in handling gas supplies and are able to prove this.
- The persons have up-to-date knowledge and experience in gas supplies, and they have actively practised these skills in recent years.



Injury hazard!

Operating the machine in a negligent and inattentive manner is very dangerous.

Negligent handling, inattentiveness and a disorderly work area can cause serious injuries.

- Do NOT operate the machine if you are tired or under the influence of alcohol or medication.
 - Work attentively and with care.
 - Wear personal protective equipment.
 - Keep the work area clean and orderly.
 - Only carry out work for which training has been given.
-

NOTICE **Danger of material damage!**

Improper use of the machine can damage it. Damage can cause faults in the machine, which in turn can result in reject packs.

- Do NOT overload the machine.
- Clean and service the machine on a regular basis.
- Check if the machine is in full working order prior to starting work.
- Do NOT start the machine if you notice defects, damage or a change in the operating behaviour of the machine.
- Have faults and damage repaired immediately by an authorised technician.
- Repairs and service work should only be carried out by an authorised technician.

1.1.2 Unauthorised modifications and manufacture of spare parts

Genuine MULTIVAC spare parts and accessories provide the highest level of safety for personnel. Parts and equipment from other manufacturers have not been tested by MULTIVAC and are therefore not approved. The use of such components can alter the properties of the machine and thereby impair safe operation.



Injury hazard!

It is very dangerous to use third-party parts. The use of third-party parts endangers safe operation and can cause serious injuries.

- Do NOT perform any unauthorised modifications or conversions.
- Do NOT modify or remove any protective or safety devices.
- Use only MULTIVAC spare parts and accessories.

The manufacturer disclaims any liability for damage caused by the use of third-party parts or unauthorised modifications.



**Choose the Original
Choose Success!**

Fig. 1: Pro Original

The lubricants recommended by MULTIVAC are ideally matched to the individual modules of the machine.

NOTICE **Danger of material damage!**

The use of unsuitable lubricants can increase the wear of the machine and lead to corrosion of the transport chains. This can damage the machine.

- Only use recommended lubricants for the transport chains.

1.2 EC Conformity

In the design and construction of packaging lines, packaging machines or auxiliary packaging machines, the following regulations have been observed:

- EC Machinery Directive 2006/42/EC.
- EC Electromagnetic Compatibility Directive 2004/108/EEC (exception: industrial trucks such as lift trucks and die changing trolleys).
- Regulation 1935/2004/EC on materials and articles intended to come into contact with food.

The safety objectives of the EC Low Voltage Directive 2006/95/EC are complied with in accordance with point 1.5.1 of Annex I to the EC Machinery Directive 2006/42/EC (exception: industrial trucks such as lift trucks and die changing trolleys).

Agent authorised to compile the relevant technical documentation according to Directive 2006/42/EC:

MULTIVAC Sepp Haggenmüller GmbH & Co. KG
Department of Technical Services
Bahnhofstraße 4
87787 Wolfertschwenden, Germany

Manufacturer:

MULTIVAC Sepp Haggenmüller GmbH & Co. KG
Bahnhofstraße 4
87787 Wolfertschwenden, Germany

Managing Director:

H.-J. Boekstegers

1.3 Intended use

The machine is a piece of technical equipment to be used exclusively as a working appliance. The machine may only be operated by persons older than 14 years of age.

Use the machine only to pack products in pre-made film pouches.

The film pouches are closed with a seal seam.

For specifications, see Technical specifications.

Any other use is considered improper and can endanger persons, the product and the machine.

1.3.1 Electromagnetic compatibility (EMC)

The machine has been designed for use in residential, business and industrial areas (without a separate power substation, it can be connected directly to the public mains). Operation can be impaired when used in an industrial environment.

1.3.2 Non-ionising radiation

The machine produces unintended non-ionising radiation. This is only emitted by electrical operating equipment as a function of its inherent technical nature. e.g. from electric motors, high voltage wires, magnetic coils. There are moreover no strong permanent magnets built into the machine. Any effect on active implants can therefore be excluded with a high degree of probability as long as a safety distance of 30 cm is maintained between the implant and the field source. Active implants can be: heart pacemakers, defibrillators etc.

1.4 Reasonably foreseeable incorrect use

The following work methods are not in accordance with regulations and therefore are prohibited:

- Operating in an atmosphere capable of explosion.
- Inserting or packing of highly flammable, combustible or explosion-prone products.
- Packing of dust-forming or powder-forming material.
- Gas flushing of film pouches with explosive gas mixtures (e.g. oxygen proportion over 21 %).
- Use of the chamber lid as a storage, working or cutting surface.
- Cleaning of the chamber lid with cleaning agents which have an abrasive effect (e.g. abrasive household liquid cleaner, scouring pads, steel wool etc).
- Aseptic packing of products.



Info

Misuse will exclude any liability on behalf of the manufacturer. In such a case, the operating company is solely responsible.

1.5 Warning against incorrect use

- Incorrect operation
For example: sealing times that are too short or too long and therefore result in improperly sealed packs which in turn damage the product.
- Neglecting the following work tasks:
 - Inspections.

- Cleaning work.
- Maintenance work.
- Use of third-party parts, i.e. parts that are not MULTIVAC spare parts.
- Operation under prohibited ambient conditions.

1.6 Residual risks

The safety instructions in this manual serve as guidelines for trained operating personnel in safe working practice with the machine. The manufacturer cannot however foresee all possible product-related hazards. This is why the safety instructions and warnings on the machine and in this manual cannot be considered exhaustive. The operating company and operating personnel remain ultimately responsible for safety.

1.7 Obligations of the operating company

1.7.1 Creating the operating directive

The machine and operating materials are a potential source of hazards. The operating company is obliged to draw up an operating directive. The operating directive regulates the handling of hazardous machines or operating materials, as well as laying down rules for behaviour in the case of an emergency. The required information can be found in the following documents:

- The EC directives for worker protection.
- National legislation.
- Accident prevention regulations.
- The machine instruction manual.

1.7.2 Monitoring obligation

The operating company is obliged to continuously monitor the condition of the entire machine, for example:

- Visible defects or damage.
- Changes in the operating behaviour.
- Age of the machine.

The operating company is obliged to ensure, that the machine is no longer operated when it is older than 19 years. The correct functioning of the safety functions for the electronic components can no longer be guaranteed after this age. The year of manufacture on the type plate of the machine serves as the starting point for assessing the age. In order to be able to operate the machine after this, the operating company must commission the manufacturer to check the safety functions of the machine.

**Info**

Do NOT start up the machine, if there are visible defects or if the machine is older than 19 years.

1.7.3 Making the selection of personnel

The operating company has to choose the personnel according to the tasks to be carried out, see Section 1.1.1 "TARGET GROUP". The operating company has to order and authorise the personnel for the tasks to be carried out.

**Info**

Trainees or other persons receiving instructions may only operate the unit under the constant supervision of an experienced technician.

1.7.4 Training the personnel

The operating company is responsible for ensuring, that the personnel is trained and instructed in accordance with the tasks, which have been assigned to them. The following measures can for example contribute to the training and instruction:

- Provide an operating directive, which is comprehensible to the personnel.
- Instruct personnel on how to handle the machine correctly.
- Make the machine instruction manual accessible to the personnel. If necessary, order an instruction manual from the manufacturer in the appropriate official language.
- Inform the personnel about measures for avoiding hygiene risks.
- MULTIVAC offers appropriate training courses.

1.7.5 Providing personal protective equipment

The operating company must ensure that the operators wear the required personal protective equipment (foot protection, head gear, gloves, etc.) in accordance with the national directives which apply. In Europe the directive 89/656/EEC specifies the minimum mandatory requirements for the use of personal protective equipment.

1.7.6 Avoiding hazards

The operating company must check, whether there are special hazards during operation, e.g. through hazardous fumes. The operating company must undertake measures to avoid or limit the hazards.

1.7.7 Providing the installation location

The operating company is obliged to provide a suitable installation location for the machine. The requirements for the installation location can be obtained from the manufacturer.

1.7.8 Provide power supply

Connect the machine to the mains electricity at an always easily accessible place. In the case of an emergency the machine must be capable of being disconnected immediately from the mains electricity. The power supply must be equipped as follows:

- Overcurrent protective device according to IEC 60204-1: 2005.
- Mains power breaker according to IEC 60204-1: 2005.

Connection via residual current protective device

If the machine is to be operated via a residual current protective device, a residual current protective device which is sensitive to all types of current should be used.



Info

In exceptional cases, the leakage current can be so high that an isolating transformer needs to be installed between the power supply and the machine.

Connection to IT network

The machine cannot be connected directly to an IT network. The IT network must be converted to a TN-S network by an isolating transformer. The machine is connected to the TN-S network.

1.7.9 Observe the requirements for the gas supply



Info

Compliance with the following requirements is mandatory and is one of the operating company's imperative obligations!

General requirements

- The operating company is obliged to connect the gas supply in a way that poses no danger to employees or third parties.
- The operating company is obliged to create an instruction manual with all safety-related information for the following phases in the service life of the machine:
 - Starting up.
 - Operation and conduct in the event of unusual occurrences.
 - Servicing during operation.
 - Shutdown.
 - Rectification of faults.
- All parts of the gas supply and its equipment, which come into contact with oxidizing acting gases, are to be kept free of oil and grease.

- The operating company must ensure that the input and operating pressures given in the Technical specifications are adhered to and not exceeded.

Personnel qualifications

Only qualified persons with the corresponding required training, experience and reliability may perform work on the gas supply.

Structural requirements

- The operating company is obliged to install a pressure reducer and safety valve in the gas supply line to the machine.
- The operating company is obliged to connect the machine to the gas supply with a lockable ball valve.
When the ball valve is closed, the supply of gas to the machine is interrupted.
- It must be ensured that the input pressure at the machine does not exceed that given in the Technical specifications, e.g. through the fitting of an overpressure valve.
- The pressure relief capacity of the safety valve must be dimensioned for the maximum possible throughput of the pressure reducer.
- In the case of a release of pressure, the gas must be diverted to non-hazardous areas.

1.7.10 Avoiding hygiene risks

A high standard of hygiene is achieved through design, choice of materials and workmanship.

It is imperative that this high level of hygiene be maintained by every operating company. Particularly where food or sterile medical products are being packed, the currently valid hygiene standards must be strictly observed. The person charged by the operating company with safety and/or hygiene must clarify, which regulations apply to the product to be packed, and the person must then implement these regulations.

The manufacturer assumes no liability whatsoever for any warranty claims and damage claims of any kind resulting from insufficient hygiene and insufficient cleaning.



Health hazard!

Insufficient or sporadic cleaning can promote the growth of micro-organisms which can change unfavourably the product that is to be packed.

This can severely damage the health of people, especially of the consumers.

Among other measures the following are definitely required:

- Create a company cleaning guideline.
- Perform cleaning regularly.
- Check the effectiveness of cleaning procedures on a regular basis.
- Follow instructions in the chapter 'Cleaning'.

1.7.11 Checking the packs



Health hazard!

Faulty or damaged packs (reject packs) can have far-reaching consequences, for example, spoiled products.

Spoiled products can pose a health hazard.

- Check packs on a regular basis during running operation.
- Do NOT put faulty or damaged packs (reject packs) into circulation.



Info

It is the operating company's duty to determine the overall testing procedure.

Testing procedure

Depending on the film pouch and the demands placed on the packs, various types of testing procedures are available, e.g.:

- Check seal seam width.
- Visual inspection: Asses the pack optically.
- Storage test: Store a good pack for a defined period and then re-inspect.
- Stacking test: Stack good packs on top of each other for a defined period and then re-inspect.
- Check the seal seam strength with a tensile testing machine.
- Low-pressure test (for vacuum packs).
- Measurement residual oxygen (for gas-flushed packs).

The following faults can result in a pack not being airtight:

- A leaky seal seam. Possible reasons:
 - The inside of the packaging material is contaminated by product in the seal seam area.
 - The sealing time is too short.

- Damage to the pack caused e.g. by sharp-edged products.

Time of inspection

- After machine start-up.
- When a defined time interval was reached during running operation.
- When the pack size was changed.
- When other types of films or other film thicknesses are being used.
- When spare parts or wearing parts were built in.
- After faults to the machine were eliminated.
- After changes to the machine settings.

1.7.12 Pump protection function

The vacuum pump in the machine runs for a set time when the chamber lid has been closed. During this time any undesired liquid in the oil of the vacuum pump evaporates. This increases the lifespan of the vacuum pump. When packaging moist or liquid products, the operating company is obliged to perform this function at least once a day at the end of a working day. The manufacturer assumes no liability whatsoever for any warranty claims and damage claims of any kind that result from the insufficient performance of this function.

NOTICE Danger of material damage!

Penetration by foreign matter (e.g. liquids, product residue, foreign bodies) will damage the vacuum pump.

Damage can cause faults in the machine, which in turn can result in reject packs.

- Cancel the evacuation process immediately if foreign matter is sucked in.
 - Change the oil in the vacuum pump.
-

1.7.13 Testing pressure equipment

The operating company is responsible for observing the country-specific test intervals for pressure equipment. This test is to be performed by qualified persons.

1.8 Danger zones

Be particularly aware of the following danger zones:



Fig. 2: Danger zones

- 1 Chamber lid
- 2 Vacuum pump
- 3 Electrical system



Injury hazard!

Altered, damaged, defective or incorrectly applied or missing safety devices will render the danger zones unprotected. Unprotected danger zones can cause serious or even fatal injuries.

- Do NOT alter the safety devices.
 - Use only MULTIVAC spare parts and accessories.
- Before switching on the machine each time:
- Check that all safety guards close completely and prevent reaching into the danger zones.
 - Check that only those safety devices are used which are suitable for the machine equipment.
 - Check that all safety devices are functional and in a technically flawless condition.

1.8.1 Chamber lid



Danger of crushing!

The gas strut is unhooked by opening the chamber lid completely. The chamber lid can therefore fall down unimpeded. Reaching in between the housing and the falling chamber lid can lead to crushing injuries.

- Close the chamber lid by hand and do NOT let it fall down.

1.8.2 Vacuum pump



Burn hazard!

The surface of the vacuum pump can reach temperatures of over 70 °C during operation.

Touching the vacuum pump can lead to burns.

Before performing any work on the vacuum pump:

- Allow the vacuum pump to cool down.
- Wear personal protective equipment.

1.8.3 Electrical system



Dangerous voltage!

Inside are electrically charged components.

Touching electrically charged components can cause serious or even fatal injuries.

- Before opening the housing, disconnect the machine from the mains electricity.
- Only qualified electricians are permitted to work on electrically charged components.
- Do NOT touch damaged electrical cables but have them replaced immediately by a qualified electrician.
- If any electrical cables are damaged, stop the machine immediately.

1.9 Safety devices

The housing is a safety guard and prevents the reaching into danger zones. The closed housing must be secured with the screws before the machine can be operated.

1.10 Machine labelling

Safety and information labels have been attached to the machine.

- Do NOT remove these labels.
- Make sure all labels are intact and legible.

- If necessary, clean the labels with soap and water.
 - Do NOT clean the labels with solvents.
- Replace damaged, scratched or illegible labels with new ones.



Info

Labels can be obtained from the manufacturer.

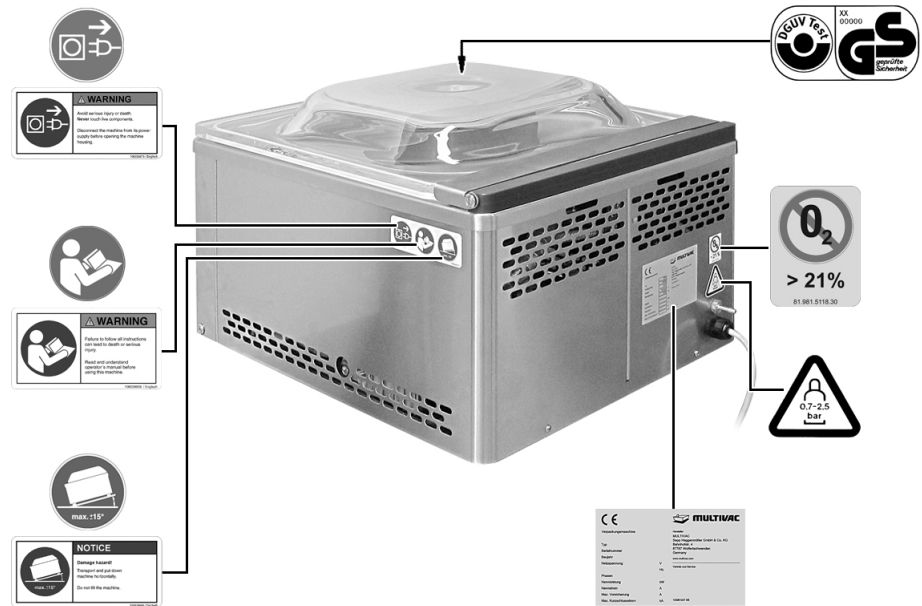

Fig. 3: Safety labels and information labels

Position

Sign



Fig. 4:
SO mandatory sign:
Read the
instruction
manual



Fig. 5: ANSI mandatory sign: Read the instruction manual (English / French)



Fig. 6: ANSI mandatory sign: Read the instruction manual (English / Spanish)



Fig. 7: ANSI mandatory sign: Read the instruction manual (English / Chinese)

2 Description

2.1 Construction of the machine

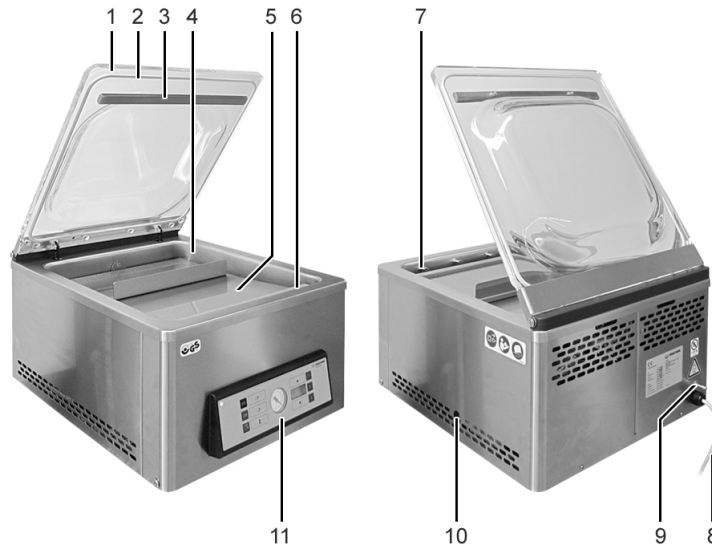

Fig. 8: Construction of the machine

- 1 Chamber lid
- 2 Chamber lid gasket
- 3 Counter-pressure bar
- 4 Chamber
- 5 Filling plates and sloping insert with support angle
- 6 Sealing bar
- 7 Inert gas nozzle (option)
- 8 Power supply
- 9 (Optional) Inert gas connection
- 10 Oil sight glass
- 11 Control terminal

2.2 Optional equipment

2.2.1 Gas flushing system

As an option, the machine can be equipped with a gas flushing system. The products are gas flushed with inert gas and packaged in the modified atmosphere.

Gas flushing with inert gas has the following advantages:

- It extends the shelf life of the product.
- It reduces oxygen content.
- It avoids putting pressure on the product.

2.3 Control terminal

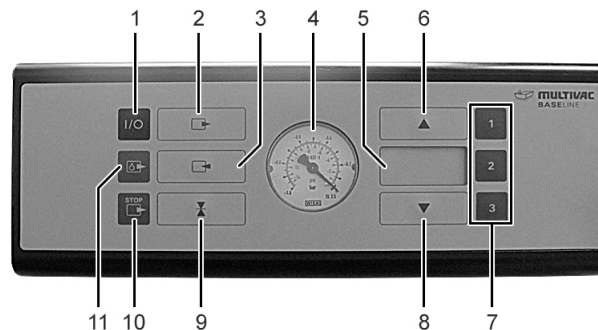

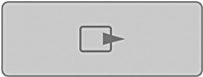
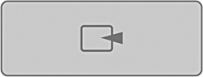







Fig. 9: Control terminal

- 1 <Machine control On/Off> key
- 2 <Evacuation> key
- 3 <Gas flushing> key
- 4 Pressure display
- 5 Display
- 6 <Arrow> key
- 7 Keys <1> to <3>
- 8 <Arrow> key
- 9 <Sealing> key
- 10 <Stop> key.
- 11 <Pump protection> key

	<p><Machine control On/Off></p>	<ul style="list-style-type: none"> • Switch machine control on and off • Abort the packaging procedure at any time (e.g. the film pouch has slipped out of position or the packaging procedure was started with the incorrect recipe). • Abort pump protection function.
	<p><Evacuation> key</p>	<p>Call up evacuation time.</p>
	<p><Gas flushing> key</p>	<p>Call up gas flushing time.</p>
	<p>Pressure display</p>	<p>Shows the pressure difference between the chamber and the outside environment. Example: if the indicator is at -0.6 bar, this corresponds to a pressure difference of 600 mbar between the chamber and the outside environment.</p>

	Display	<ul style="list-style-type: none"> • Display process data. • Display settings. • Display diagnostic messages.
	<Arrow key>	Increase values.
	Keys <1> to <3>	Load and save recipes.
	<Arrow key>	Decrease values.
	<Sealing> key	Call up sealing time.
	<Stop> key.	<ul style="list-style-type: none"> • Deactivate pump protection function <p>With machines without inert gas:</p> <ul style="list-style-type: none"> • Abort evacuation and then seal (e.g. if liquid products begin to boil). <p>With machines with inert gas:</p> <ul style="list-style-type: none"> • Press during evacuation: abort evacuation and then gas flush (e.g. if liquid products begin to boil). • Press during gas flushing: abort gas flushing and then seal.
	<Pump protection>	Activate pump protection function see Section 4.9 "PERFORM PUMP PROTECTION FUNCTION"

2.4 Display

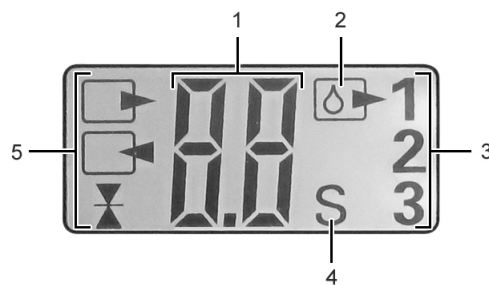





Fig. 10: Display

- 1 Numeric display
- 2 Icon for pump protection
- 3 Recipe display
- 4 Display of the unit
- 5 Function display

Numeric display	<ul style="list-style-type: none"> • During the packaging procedure: display of the remaining time of the current process. • With chamber lid opened: display of the times currently set.
Icon for pump protection	<ul style="list-style-type: none"> • Icon is not displayed: pump protection function is inactive. • Icon flashes: pump protection function is running. • Symbol is displayed continuously: pump protection function is activated and can be started by pressing the chamber lid shut.
Recipe display	Shows the currently loaded recipe. If the current settings have not yet been saved as a recipe, no number is displayed.
Display of the unit	<ul style="list-style-type: none"> • Unit 's' is displayed: the time in the display is shown in seconds. • There is no unit displayed: the time in the display is shown in minutes.
Function display	<p>The function display shows the active processes for the packaging procedure and the progress within the packaging procedure. The individual processes are depicted as symbols.</p> <p>Meaning when the chamber lid is open:</p> <ul style="list-style-type: none"> • Symbol is not displayed: the process is bypassed during the packaging procedure. • Icon flashes: the time which is called up can be set with the arrow keys. • Symbol is displayed continuously: the process is performed during the packaging procedure. <p>Meaning during the packaging procedure:</p> <ul style="list-style-type: none"> • Icon is not displayed: the process has been performed or bypassed. • Icon flashes: the process is just being performed. • Icon is continuously displayed: the process has not yet been performed.

2.5 Process sequence

The film pouches are filled and laid in the chamber. When the chamber is closed, the following processes run automatically:

	Evacuation	Evacuation if chamber and film pouches.
	Gas flushing (option)	Infeed of inert gas.
	Sealing	Sealing of film pouches.

2.6 Times which have to be set

Times must be set for evacuation, gas flushing and sealing. The times depend on the product and the film pouch used. A pressure difference of at least -0.35 bar is required during the evacuation and gas flushing processes, so that the chamber lid remains closed. A pressure difference of at least -0.35 bar is also required before the sealing process, so that the film pouches can be sealed. The pressure difference can be read at the pressure display on the machine control.

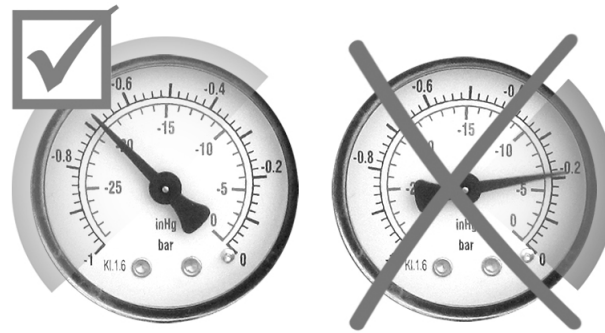

Fig. 11: Areas on the pressure display

Time	Explanation
Evacuation time	Air is suctioned out of the chamber and the film pouches during this time. The longer the evacuation time, the better the vacuum and the quality of the seal seam. Too long an evacuation time can damage sensitive products (e.g. raw or pre-cooked pasta, cooked vegetables). In the case of liquid products, the evacuation process should be stopped with the <Stop> key shortly before the product begins to boil. Recommended value: at least 3 s In the case of a packaging procedure with gas flushing, the evacuation time must be extended.

Time	Explanation
Gas flushing time (option)	The film pouch is filled with inert gas during this time. The time depends on the input pressure at the inert gas connection and on the vacuum level reached in the chamber. If the gas flushing time is too long, the chamber lid can open or the quality of the seal seam can be impaired. The pressure difference becomes too small. Recommended value: 1 s to 3 s
Sealing time	The film pouch is sealed during this time. The sealing time depends on the material and thickness of the film pouch. Recommended value: 1.5 s to 1.7 s

2.7 Technical specifications

Power supply

Mains voltage	220 V - 240 V/50Hz - 60 Hz	100 V - 115 V/50Hz - 60 Hz
Phases	1/N/PE AC	
Nominal power	0.9 kW	
Nominal current	5.6 A	12.5 A
Maximum mains fuse	16 A	20 A
Maximum short circuit current	5 kA	
Protection type	IP54	

Dimensions

Height (a) with open chamber lid	745 mm
Height (a) with completely open chamber lid	910 mm
Height (a) with closed chamber lid	400 mm
Width (b)	520 mm
Depth (c)	640 mm
Operating height approx.	315 mm
Effective chamber size (W/H/D)	420 mm/170 mm/425 mm
Sealing length	420 mm

Dimensions

Weight approx.	68 kg
----------------	-------



Fig. 12: Dimensions

Installation conditions and ambient conditions

Ambient temperature	+2 °C to +40 °C
Storage temperature	-25 °C to +80 °C
Relative air humidity during operation or storage of the machine, max.	90 % non-condensing
Inclination of the machine during transport, max.	15 °
Requirements for the location of the machine	<ul style="list-style-type: none"> • Level surface. • Sufficient load bearing capacity. • Free of damage.
Minimum distance on all sides of the machine	100 mm
Minimum room size for machines with gas flushing option*	40 m ²

*For safety reasons, a minimum room size is mandatory to prevent high concentrations of gas.

Inert gas (option)

Max. input pressure	2.5 bar
Min. input pressure	0.7 bar
Inner diameter of supply line	8 mm

Vacuum pump

Vacuum pump	20 m ³ /h
Achievable final pressure approx.	2 mbar

Noise exposure at the workplace

Based on	Machinery Directive (2006/42/EC)
Measuring instrument	Sound level meter, IEC 61672- 1, class 1, error limit +/-1.1 dB
Condition of the machine	New condition with optimum settings at the time of delivery.
A-weighted emission sound-pressure level at the workplace L _{pA} (DIN ISO 11204, accuracy class 3)	<70 dB

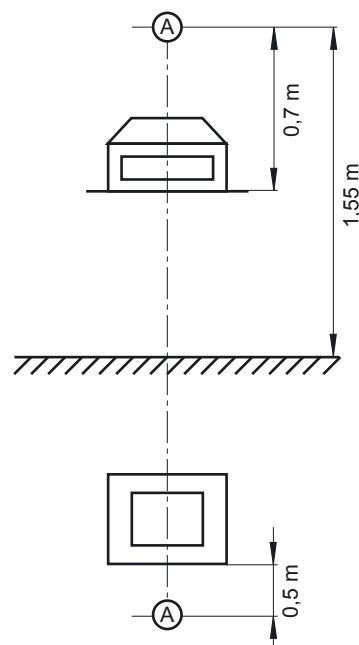

Fig. 13: Noise exposure measuring point



Info

The measured values of the noise data have been adjusted to take extraneous and ambient noises into account.

Higher measured values may be produced as a result of the following:

- Highly sound-reflecting rooms.
- Modified settings.
- Wear.

3 Start-up

3.1 Setting up the machine and starting it up



Danger of explosion!

Operating the machine in a potentially explosive atmosphere can result in explosion due to hot machine parts.

Explosions can cause serious injuries or even death.

- Do NOT use the machine in rooms that are exposed to explosion hazards.

- Prepare a firm, level site for the machine.
 - The site should be at least twice the size of the machine's footprint (so that for example the housing can be opened).
 - To ensure adequate space for cooling, there must be a clear distance of at least 100 mm on all sides of the machine.

- Ensure that there is adequate access to the connections.

- Have the power supply of the machine fitted by a qualified electrician with a suitable mains fuse in accordance with IEC 60204-1:2005. See the machine type plate or technical specifications for the dimensions of the mains fuse.



Injury hazard!

The machine is heavy.

Carrying the machine can cause injuries.

- Have a second person assist you.

- Lift the machine carefully out of the box and place it on the prepared site.

Start-up

Setting up the machine and starting it up



-
- Position the machine on the site in such a way that the power supply is on the right side.
-



-
- Open the chamber lid. Open the chamber lid more than half way so that it remains open.
 - The chamber lid remains open in the middle position.
 - Take all the objects out of the chamber apart from the sealing bar.
-

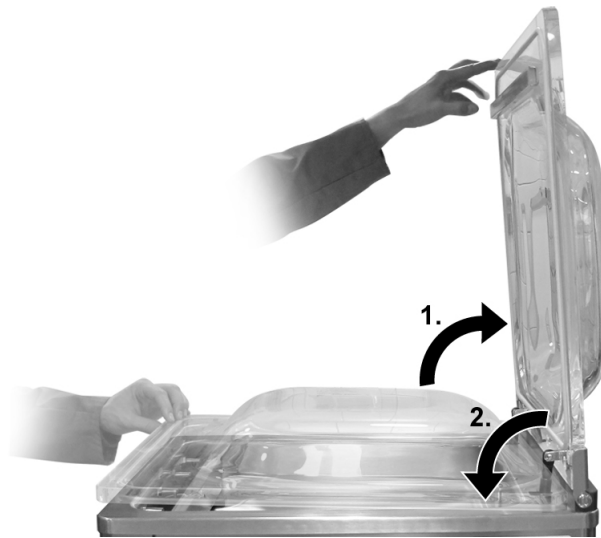

-
- Close the chamber lid. So that the chamber lid remains closed, first open it as far as the limit stop and then close it.
-



-
- Unscrew the two screws at the rear of the machine. Turn these screws anticlockwise.
-

Start-up

Setting up the machine and starting it up



-
- Lay a soft underlayer in front of the machine.
 - When the housing is opened, the control terminal lies on the underlayer.
 - Ensure that the machine is not connected to the mains electricity.
-

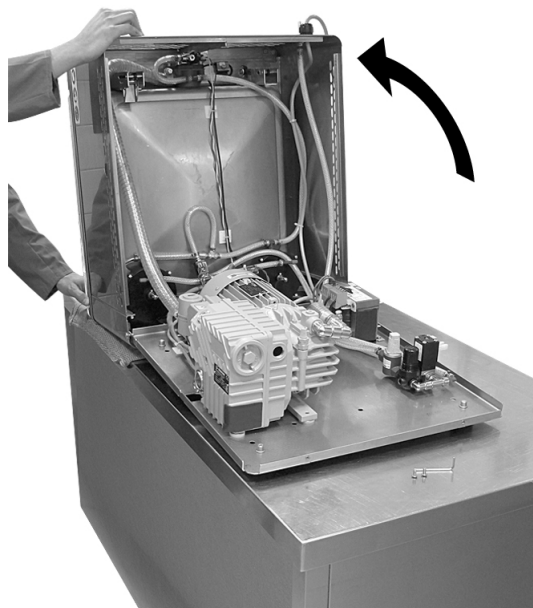

-
- Open the housing completely (slightly more than 90 °). Close the chamber lid and hold it closed when opening the housing.
 - The whole control terminal is lying flat on the underlayer.
 - The base plate of the machine is raised at the pivot point of the housing by several centimetres.
-

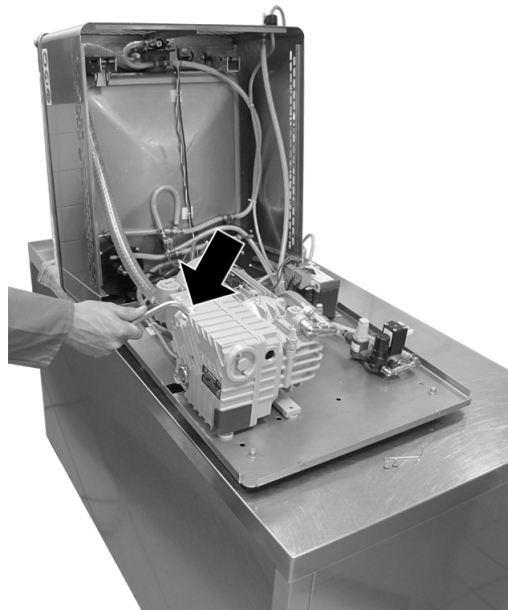

-
- Unscrew the screw plug. To do so, turn the screw plug anticlockwise.
-

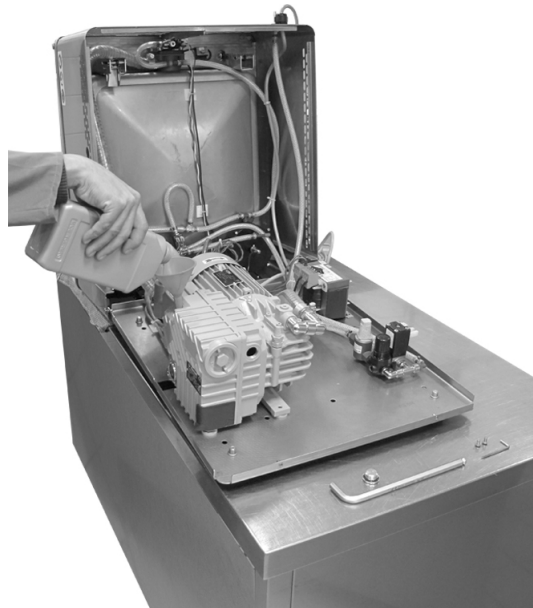

-
- Fill the vacuum pump with the oil supplied up to the middle of the oil sight glass.
 - The oil level is then approximately in the middle of the oil sight glass.
-

Start-up

Setting up the machine and starting it up

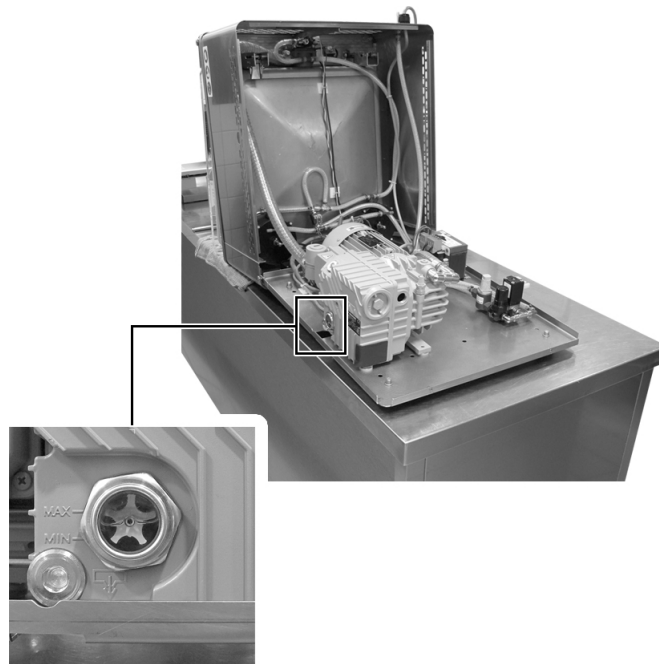

-
- Check the oil level on the oil sight glass.
 - If too much oil has been filled into the vacuum pump, drain off excess oil:
-

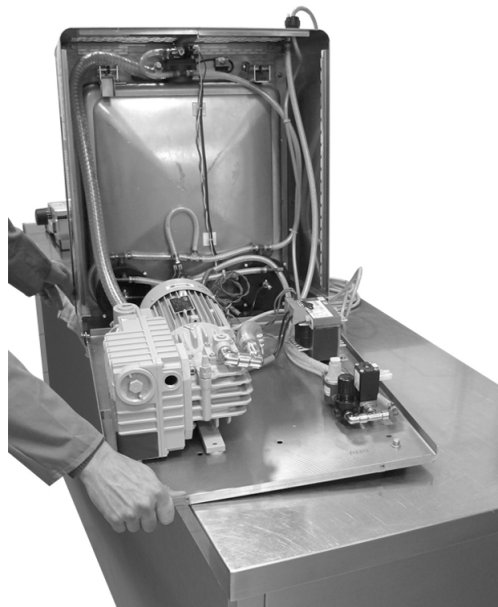

- Position the machine such that a liquid container can be held under the oil sight glass.



- Place filling plates under the base plate so that the base plate is even.
- Hold the liquid container (e.g. an oil bottle) under the drain opening.

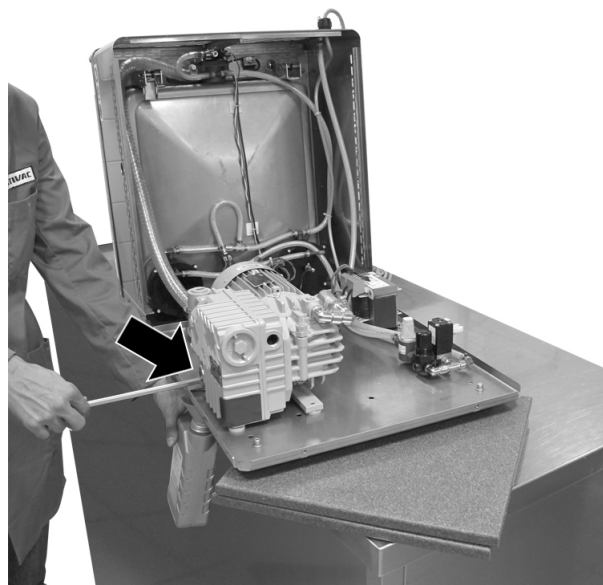

- Unscrew the screw plug. To do so, turn the screw plug anti-clockwise.
- Only drain so much oil until the oil level is roughly in the middle of the oil sight glass.
- Screw the screw plug tightly in the drain opening. To do so, turn the screw plug clockwise.
- Wipe off and remove any oil from the machine.

Start-up

Setting up the machine and starting it up

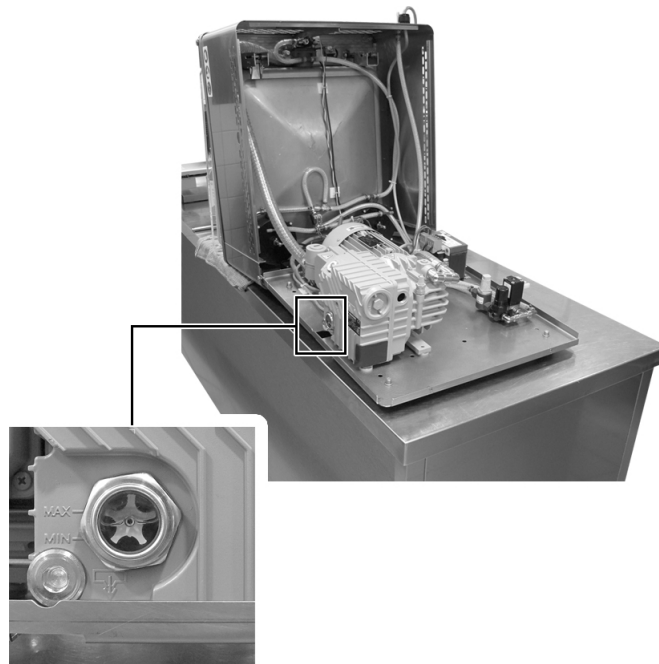

- Check the oil level on the oil sight glass.
- Turn the screw plug in the fill opening and screw it tight. To do so, turn the screw plug clockwise.
- Wipe off and remove any oil.

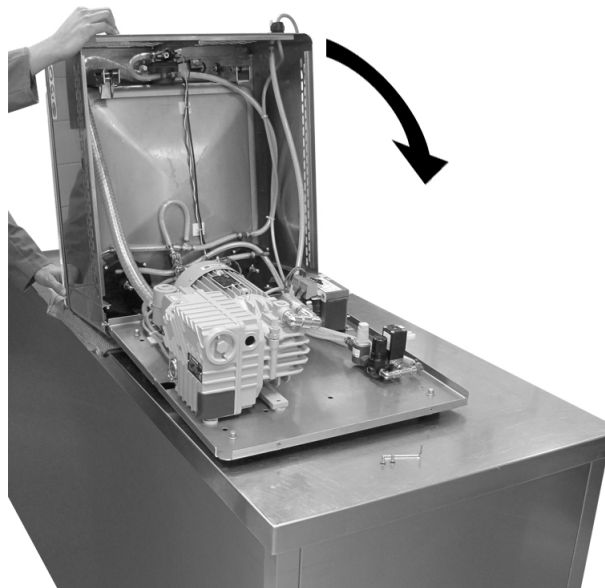

- Close the housing. Ensure that there are no cables between the housing and the base plate.



-
- Tighten the two screws at the rear of the machine. Turn these screws clockwise.
 - The housing is closed and tight.
-



Danger of explosion!

Gas mixtures with oxygen proportions over 21% are explosive. A gas mixture with an oxygen proportion over 21 % can cause an explosion and fire if it comes in contact with heat, oil or grease.

- Do NOT use a gas mixture with an oxygen proportion of over 21%.
-



Risk of death!

During the packing process, inert gases are released. Inhaling inert gas can impair your breathing. Over a longer period of time, this can be fatal.

- A surface area of at least 40 square meters per machine must be made available.
 - Ventilate the rooms sufficiently and avoid any accumulation of gas.
 - Observe the maximum input pressure, see 'Technical specifications'.
 - Cut off the gas supply at the end of work.
 - Adhere to the safety regulations in effect in the country where the machine is used.
-

- Connect the inert gas (only for machines with inert gas connection).
 - Close the stop-cock for the gas supply.
-

Start-up

Setting up the machine and starting it up



- Attach the gas hose to the inert gas connection of the machine.
 - Fasten the hose with hose clamps.
 - Open the stop-cock for the gas supply.
 - Set the input pressure; see Technical Specifications.
-
- Check the mains voltage on the type plate and compare it with the voltage of the mains electricity.
-
- If the values match, connect the machine to the mains electricity at a place which is always easily accessible.
-
- Remove all the protective film.
-
- Clean the machine, see Section 6 "CLEANING"
-

4 Operation

4.1 Opening and closing the chamber lid



-
- Open the chamber lid more than half way so that it remains open.
 - The chamber lid remains open in the middle position.
-

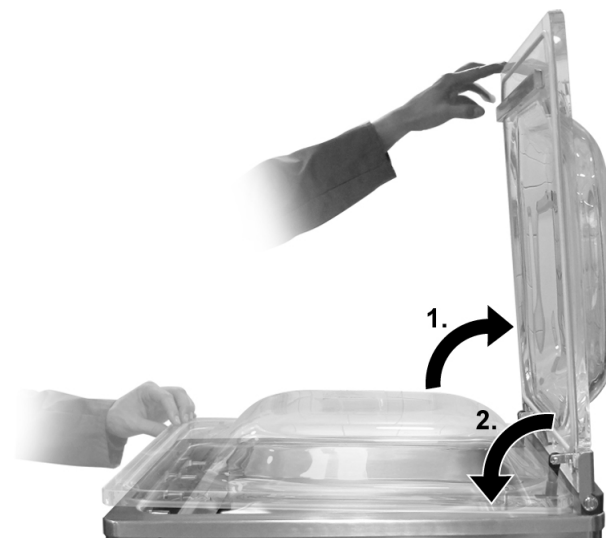

-
- So that the chamber lid remains closed, first open it as far as the limit stop and then close it.
-



-
- To start the machine after it has been switched on, firmly press the opened chamber lid shut against the resistance by pressing the middle of its front edge.
 - The chamber is closed when the chamber lid is completely shut.
 - The vacuum pump runs.
 - If the chamber lid is properly pressed shut, the pressure display shows a pressure difference.
 - The chamber lid opens automatically after the packaging procedure.
-

4.2 Switching on the machine

- Before switching on the machine for the first time fill the vacuum pump with oil, see Section 7 "MAINTENANCE".
-
- If present, open the stop-cock for the gas supply.
-
- Connect the machine to the mains electricity in a place which is always easily accessible.
-
- Press the <Machine control On/Off> key.
 - The machine control performs a self-test.
 - The software version of the machine control briefly appears in the display.
 - The machine is ready for operation.
-

4.3 Switching off the machine

- Press the <Machine control On/Off> key.
 - The "pump protection" icon flashes in the display.
 - If necessary, perform the pump protection function, see Section 4.9 "PERFORM PUMP PROTECTION FUNCTION".
 - To switch off the display immediately, press the <Machine control on/off> key again.
-



Info

The display goes out automatically after 10 s without input or without closing the chamber lid.

-
- Close the chamber lid. So that the chamber lid remains closed, first open it as far as the limit stop and then close it.

-
- Close the stop-cock for the gas supply, if part of the machine.
 - If required disconnect the machine from the mains electricity.
-

4.4 Setting the times

- Press the key for the desired function.
 - The icon of the function flashes in the display.
 - To set the *evacuation time*, press the <Evacuation> key.
 - To set the *gas flushing time*, press the <Gas flushing> key.
 - To set the *sealing time*, press the <Sealing> key.
 - Using the <arrow> keys, set the desired value.
 - The value is adopted.
 - To change the value slowly, press the <arrow key> briefly.
 - To change the value quickly, hold the <arrow key> pressed down.
-



Info

If the value for the gas flushing time or sealing time is set to 0, the function is switched off and the symbol of the function is not shown in the display.



Info

With effect from software version 2.3, the *evacuation time* changes as of 60 s from a display in seconds to a display in minutes. With effect from one minute, the *evacuation time* can only be set in tenths of a second.

-
- Press the key of the function again.
 - The icon of the function is shown continuously in the display.
-

4.5 Packing products

- Open the chamber lid. Open the chamber lid more than half way so that it remains open.
 - The chamber lid remains open in the middle position.
-

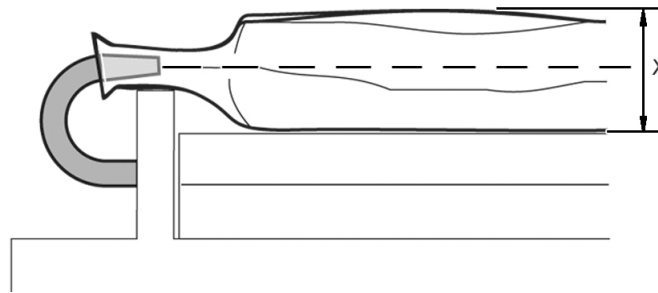

- If necessary, use filling plates.
 - The pouch neck should be located at the centre of the pouch height x.
- Use the sloping insert for packaging liquids, see Section 5.1 "INSERT AND REMOVE THE SLOPING INSERT".
 - Liquid cannot escape from the film pouch.
- Switch on the machine.
- Set the times.



Health hazard!

Insufficient or sporadic cleaning can promote the growth of micro-organisms which can contaminate the product. This can pose serious health hazards for consumers.

- Disinfect your hands should they come into contact with any machine part other than the operating elements.
- Do NOT lay the product on the machine.
- Observe the company cleaning guidelines.
- Follow instructions in the chapter 'Cleaning'.



Info

The products should be as cool as possible for a good pack result. The optimum temperature for the packaging procedure is approx. 2 °C.



-
- Insert film pouch.
 - The opening of the film pouch should extend 2 to 3 cm beyond the sealing device.
-
- Gas flushing option: Pull the opening of the film pouch over the nozzles so that inert gas flows into the film pouch.
-
- Pull the pouch neck flat on the sealing bar.
 - The pouch neck lies on the sealing bar without creases.
-

NOTICE Danger of material damage!

Penetration by foreign matter (e.g. liquids, product residue, foreign bodies) will damage the vacuum pump. Damage can cause faults in the machine, which in turn can result in reject packs.

- Cancel the evacuation process immediately if foreign matter is sucked in.
 - Change the oil in the vacuum pump.
-
- To start the machine after it has been switched on, firmly press the opened chamber lid shut against the resistance by pressing the middle of its front edge.
 - The processes in the machine run automatically.
 - The chamber lid opens automatically after the packaging procedure.
-



-
- Detach the pouch neck.
 - Check the pack.
-



Info

Visually inspect the packs on a regular basis while the machine is running. Depending on product and pack it may be necessary to carry out additional and considerably more complex test procedures. This is the responsibility of the operating company, see Section 1.7.11 "CHECKING THE PACKS".

-
- If necessary, adapt the times to the product.
 - Save recipe, see Section 4.8.2 "SAVE RECIPE".
-

4.6 Aborting evacuation



Info

Vacuum lowers the boiling point of liquids. This means that liquid products can boil during the evacuation process. The boiling product contaminates the film pouch in the area of the seal seam and the film pouch can therefore no longer be sealed.

-
- If the product begins to boil during the evacuation process, abort the evacuation process with the <Stop> key.
 - With machines without inert gas: the film pouch is sealed. The chamber lid then opens automatically.
 - With machines with inert gas: the film pouch is gas flushed and sealed. The chamber lid then opens automatically.
-

4.7 Aborting packaging procedure



Info

The packaging procedure can be aborted at any time (e.g. the film pouch has slipped out of position or the packaging procedure was started with the incorrect recipe).

-
- To abort the packaging procedure, press the <Machine control On/Off> key.
 - The display goes dark.
 - The chamber is ventilated.
 - The chamber lid opens automatically.
 - The product is not packaged.
-

4.8 Working with recipes

4.8.1 Load recipe

-
- Press the desired key briefly <1> to <3>.
 - The recipe number appears in the display.
 - The selected recipe is loaded.
-



Info

If the settings are changed after a recipe has been loaded, the recipe number goes out in the display.

4.8.2 Save recipe

-
- Hold the desired key <1> to <3> pressed down for 5 s.
 - The recipe number flashes in the display and is then displayed continuously.
 - A recipe which is already saved is overwritten.
 - The current values are stored in the selected recipe.
-

4.9 Perform pump protection function

-
- Press the <Pump protection> key.
 - The "pump protection" icons appears in the display.
 - The duration of the pump protection function is displayed in minutes.
 - The pump protection function is activated.
 - To deactivate the pump protection function, press the <Stop> key again.
 - The "pump protection" icon goes out.
 - The pump protection function is deactivated.
-

-
- To start the machine after it has been switched on, firmly press the opened chamber lid shut against the resistance by pressing the middle of its front edge.
 - The pump protection function starts.
 - The "pump protection" icon flashes.
 - The vacuum pump runs for 20 minutes.
 - The chamber lid opens automatically.
 - The display goes dark.
-
- To abort the pump protection function, press the <Machine control On/Off> key, while the vacuum pump is running.
 - The chamber lid opens automatically.
 - The display goes dark.
-

5 Adjustment work and setup

5.1 Insert and remove the sloping insert

- If necessary, use filling plates for the desired incline.
 - Hook the sloping insert on the screws of the sealing bar.
-

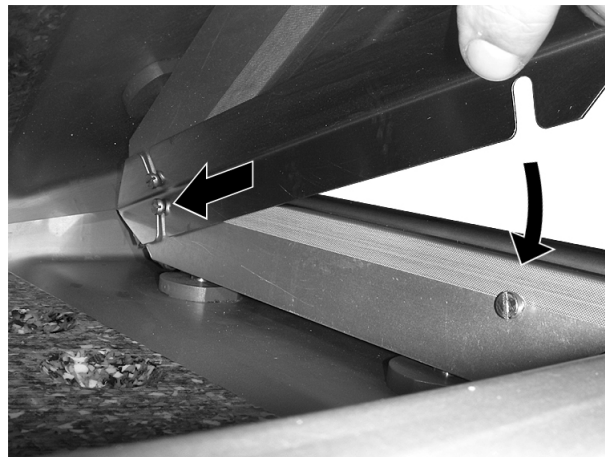

- Attach the support angle to the sloping insert at the required position.
-

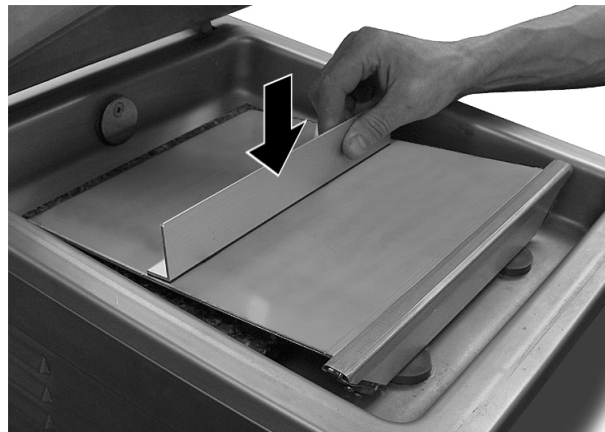

- If the sloping insert is no longer needed, remove it, along with the support angle, from the chamber.
-

6 Cleaning

The objective of the cleaning work is to avoid risks to hygiene. If the cleaning is insufficient or not performed properly, this may result in the contamination of the products and to health hazards for end consumers. In addition, the machine may be damaged.



Info

Optional equipment for aiding the cleaning can be retrofitted for various machine types. For further information, contact our sales and service departments.

6.1 Notes on cleaning

6.1.1 Instructions for creating company cleaning guidelines

The company operating the machine is under an obligation to create company cleaning guidelines. These cleaning instructions must be matched to the particular needs of the operating company (type of product, environment, sector etc).

The following points should be contained in the company cleaning guidelines:

- Required cleaning intervals.
- Care products to be used. For care products, refer to the "Care products table".
- Using the proper dosage of care products.
- Persons in charge of cleaning.
- The individual working stages for hygienic cleaning of the machine, taking into consideration the following points:
 - Safety instructions.
 - Instructions for maintaining the machine's value.
 - Instructions on the handling of cleansers.
 - Instructions on the handling of disinfectants.
 - Instructions on the handling of anti-corrosion agents and lubricants.
 - Instructions on the handling of cleaning devices.
 - Recommendations for the course of the daily cleaning.
 - Recommendations for the course of the intensive cleaning.
 - Qualifications of the cleaning personnel. Assign only suitably qualified and instructed personnel. Information on qualification and training can be obtained from MULTIVAC Service.
- First aid measures.

6.1.2 Instructions for maintaining the machine's value

Regular and proper care helps to maintain the machine's value. The best protection against harmful influences is to clean and disinfect the machine on a regular basis. The longer product residue and other aggressive deposits remain on the machine, the more harmful their corrosive effects will be. On the other hand, care products can also cause damage if they are used incorrectly.

Incorrect use of care products

- After every cleaning of the machine or its surroundings (for example the floor or adjacent machines), always thoroughly remove any care product residue from the machine with water of drinking quality. This prevents corrosion.
- Do NOT use any care products for the cleaning of the machine or its surroundings, which contain chlorine or which are highly acidic or alkaline. These create strong vapours and cause corrosion.
- Do NOT shorten the cleaning intervals for the mildly acidic cleaning and disinfection. All acidic cleansers are corrosive and they can cause embrittlement and premature aging of plastics.
- Where components are made of aluminium, it is NOT permitted to use tools which scratch metal, or to use harsh cleansers or cleaning devices which have an abrasive effect. These damage the anodised layer. The components can then corrode. Residues of cleansers and other aggressive deposits must be removed immediately.
- Do NOT use care products, which contain solvents, for components made of plastic. These can cause embrittlement and premature aging of plastics.
- Dosage and application time of the care products, as well as the correct temperature of the mixing water, must be observed. The manufacturers also provide information on the maximum permissible dosages which apply in the food area.
- If used incorrectly, care products can damage components made of rubber or plastic. Before applying care products, please take time to read the instructions and warnings provided by the manufacturer.

Parameters for pre-rinsing water and post-rinsing water

The following points must be observed in order to prevent damage to the machine:

- Do NOT rinse with a steam jet or high-pressure cleaner. Only use low pressure between 4 bar and 6 bar (58 psi to 88 psi).
- Use a flat fan nozzle with a 5 ° to 15 ° inclination and an approx. 3/16 " nozzle opening.

- The temperature of the water must NOT exceed 60 °C (140 °F).
- Only rinse off with water of drinking quality.

6.1.3 Instructions on the handling of cleansers



Chemical burn hazard!

Cleansers are caustic. Caustic effects are NOT noticed immediately.

Contact with the skin can cause burns.

- Wear the prescribed personal protective equipment when handling cleansers.
- Observe the manufacturer's instructions.

- For type of cleanser, refer to the "Care products table".
- Always follow the instructions for use from the cleanser manufacturer.
- The quantity of cleanser is not the decisive factor for successful cleaning.
 - Applying amounts in excess of the proper dosage does not improve or accelerate cleaning efficiency, but only hinders the required rinsing off of the cleanser.
- Dried cleanser residues make cleaning more difficult and prolonged.
 - Even the smallest residues can inhibit the effect of the disinfection.
 - Check by measuring the pH factor of the post-rinsing water.
- Regular checks of cleaning (i.e. by contact tests) reduce the risk of product contamination.
- Insufficient cleaning cannot be compensated for by doubling the concentration of the disinfectants.

6.1.4 Instructions on the handling of disinfectants

Incorrect use of disinfectant can contaminate the product with chemicals or decrease the effectiveness of disinfection. This can pose serious health hazards for consumers.

- Always follow the instructions for use from the disinfectant manufacturer.
- Only rinse or wipe off after disinfection, if this is required by the disinfectant manufacturer.
- Always observe the applicable hygiene regulations.

6.1.5 Instructions on the handling of anti-corrosion agents and lubricants

Excess lubricants can accumulate at lubrication points. Excess grease has no lubricating function; however, it can breed micro-organisms and contaminate the product.

- For type of anti-corrosion agent, refer to "Care products table".
- Always follow the instructions for use from the manufacturer of the anti-corrosion agent or lubricant.
- Check the lubricating points regularly for the accumulation of lubricants and remove excess lubricant.
- Only use H1 or FDA-approved lubricants and anti-corrosion agents.
- Regular checking of the microbiological shelf life of the anti-corrosion agent and lubricant helps to reduce the risk of product contamination.

6.1.6 Instructions on the handling of cleaning devices

- The cleaning devices will become germ hot spots if they are not cleaned often enough. This can cause cross contamination, which will damage the product. Use only plastic brushes and brooms. Clean the cleaning devices daily and apply disinfectant afterwards.
- The exhaust air emitted and agitated by the vacuum cleaner must comply with the prescribed limit values for the packaging environment. Accordingly, the appropriate filter elements must be used in the vacuum cleaner.

6.2 Cleaning recommendations



Info

- Always clean the machine from top to bottom.
- In the following, optional equipment versions are also described. Only perform steps that correspond to the version of the machine.
- The illustrations are examples.

-
- Open the chamber lid. Open the chamber lid more than half way so that it remains open.
 - The chamber lid remains open in the middle position.
-

- Remove all products from the chamber.
-

- Switch off the machine.
-

- Disconnect the machine from the mains electricity.
-

- Cover the mains plug with waterproof plastic bags.
-

- Close the stop-cock for the gas supply, if part of the machine.

-
- Allow the machine and sealing bar to cool down.
-
- Store empty, new film pouches outside the room in a clean, dry place during the cleaning procedure.
-
- Remove all waste (e.g. product scraps, film trim) on or around the machine.
-
- Remove the following components:
 - Sloping insert with with support angle.
 - Filling plate.
 - Sealing bar, see Section 7.3.1 "REMOVE THE SEALING BAR".
-
- Check chamber lid gasket for dirt or contamination.
-



-
- If there is dirt or contamination, remove the chamber lid gasket from the groove.
-
- Take the removed components to a separate room suitable for wet cleaning
-
- Clean dismantled components manually with cleaning solution.
 - Only clean the Teflon tape of the sealing bar manually with a soft cloth or a soft brush.
-
- Wait until the contact time has elapsed (see instructions of cleanser manufacturer).
-
- Wipe with new cloth and water of drinking quality.
-
- Inspect for dirt and cleanser residues.
-
- If necessary, perform another manual cleaning and wipe it off.
-
- Disinfect the removed components with disinfectant.
-
- Wait until the contact time has elapsed (see instructions of disinfectant manufacturer).
-

- If necessary, wipe off the components with a new cloth and water of drinking quality; see instructions of the disinfectant manufacturer.

- Clean the floor with a rubber wiper.

- Dispose of the waste properly.

- Apply cleanser to the floor in the low-pressure foaming procedure.

- Wait until the contact time has elapsed (see instructions of cleanser manufacturer).

- Rinse off the floor with water of drinking quality.

- Manually clean the entire machine, including the table, with cleaning solution.
 - Only clean the chamber lid manually with a soft cloth or a soft brush.

- Wait until the contact time has elapsed (see instructions of cleanser manufacturer).

- Wipe with new cloth and water of drinking quality.

- Inspect the entire machine and the floor for dirt and cleanser residues.

- If necessary, clean and wipe off again.

- Disinfect the entire machine, including the table, with disinfectant.

- Close the chamber lid. So that the chamber lid remains closed, first open it as far as the limit stop and then close it.

- Use a hand-held spray lance to apply disinfectant to the floor.

- Wait until the contact time has elapsed (see instructions of disinfectant manufacturer).

- If necessary, rinse the floor with water of drinking quality; see instructions of the disinfectant manufacturer.

- Open the chamber lid. Open the chamber lid more than half way so that it remains open.
 - The chamber lid remains open in the middle position.

- If necessary, wipe off the machine with a new cloth and water of drinking quality; see instructions of the disinfectant manufacturer.

- Remove the plastic bag from the mains plug.

- Dispose of plastic bags properly. For reasons of hygiene, never reuse bags

-
- Attach the following components:
 - Sealing bar, see Section 7.3.2 "INSTALL THE SEALING BAR".
 - Filling plate.
 - Sloping insert with with support angle.
-

- Install the chamber lid gasket.
 - If necessary, dry the chamber lid gasket and groove with a new cloth or sterile compressed air.
 - Open the chamber lid as far as the limit stop and have a second person hold it.



- Press the chamber lid gasket into the groove of the chamber lid.
 - The beginning and end of the chamber lid gasket must butt up against each other without a gap.
 - During insertion, do not stretch the chamber lid gasket.
 - Smooth out chamber lid gasket.
-

- Leave the chamber lid open to dry.
-

- Check the chamber for leaks, see Section 7.9 "CHECK THE CHAMBER FOR LEAKS".
-

- If present, open the stop-cock for the gas supply.
-

- Connect the machine to the mains electricity.
-

- Clean the cleaning devices (e.g. rubber wipers, brushes).
-

- Place cleaning devices in disinfectant solution.
-

- Unpack the film pouches and lay them ready.
-

6.3 Care products table

Recommended care products:

Type	Manufacturer	Designation
Cleansers, neutral	Ecolab Europa	P3-topax 12

Type	Manufacturer	Designation
	Ecolab USA	Quorum Pink II
	Diversey Europe	Shureclean VK10
		JD Shureclean Plus VK9
	Diversey USA	Shureclean VK10
		JD Shureclean Plus VK9
Cleansers, alkaline	Ecolab Europa	P3-topactive LA
	Diversey Europe	JD Ultraclean VK3
		Diverfoam SMS HD VF22
	Diversey USA	JD Ultraclean VK3
		Diverfoam SMS HD VF22
Cleansers, acidic	Ecolab Europa	P3-topax 52
		P3-topax 56
	Ecolab USA	Quorum Red
		Foam shine
	Diversey Europe	JD Acifoam VF10
	Diversey USA	
Disinfectants	Ecolab Europa	P3-topax 91
		P3-topax 990
	Ecolab USA	Ster-Bac
	Diversey Europe	JD Divosan extra VT55
		JD Suredis VT1
	Diversey USA	JD Divosan extra VT55
		JD Suredis VT1
Anti-corrosion agents	Esso	Primol 352
	Castrol	Optimol F+D Fluid Spray
	Klüber Lubrication	Klüberfood NH1 K 32
Stainless steel care products	Ecolab Europa	P3-proguard MC

All recommended anti corrosion agents and stainless steel care products are food compatible.

Buying source:

- Ecolab: www.ecolab.com
- Diversey: www.diversey.com
- Esso: www.exxonmobil.com

- Castrol: www.castrol.com
- Klüber Lubrication: www.klueber.com

7 Maintenance



Dangerous voltage!

Switching off the machine does not rid it of electrical current. Touching electrically charged components can cause serious or even fatal injuries.

Before performing any cleaning or service work:

- Disconnect the machine's power supply from the mains electricity.
- Have work in the control cabinet performed by authorised technicians only.



Info

Observe the safety instructions, see Section 1 "SAFETY". Clean the machine after maintenance work and repairs and disinfect if necessary.

7.1 Maintenance schedule

As needed

		Page	Completed
Entire machine	Perform a wipe test	61	

Every 8 operating hours or daily

		Page	Completed
Vacuum pump	Perform the pump protection function	60	
Entire machine	Visual inspection	60	
Entire machine	Alkaline cleaning and disinfection	61	
Vacuum pump	Checking oil level, topping up	61	

Every 50 operating hours or weekly

		Page	Completed
Entire machine	Acidic cleaning and disinfection	61	
Connections	Visual inspection	61	

Every 1000 operating hours or yearly

		Page	Completed
Vacuum pump	Oil change	62	
Vacuum pump	Exchanging the air de-oiling element	62	
Entire machine	Check the age	62	

7.2 Service recommendation

7.2.1 Vacuum pump - Perform the pump protection function

- Perform the pump protection function, see Section 4.9 "PERFORM PUMP PROTECTION FUNCTION".

7.2.2 Entire machine - Visual inspection

- Check the entire machine for any external signs of damage.
- Check that all safety labels are present.
- Check that all safety devices are attached and undamaged.



- Check the screws on the housing.
 - Replace missing screws with new ones.
 - Tighten loose screws.

-
- Check the chamber lid for damage (e.g scratches, cracks), deformation and misting.
 - If the chamber lid is damaged, deformed or misted up, have it replaced by the service department.
-
- Check chamber lid gasket for damage.
 - If necessary, replace the chamber lid gasket, see Section 7.8 "CHANGE CHAMBER LID GASKET".
-
- Check sealing bar for damage.
 - If necessary, replace the sealing bar, see Section 7.3 "REPLACE THE SEALING BAR".
-
- Check the counter-pressure bar for damage.
 - If necessary, repair the counter-pressure bar, see Section 7.4 "REPAIR COUNTER-PRESSURE BAR".
-

7.2.3 Entire machine - Alkaline cleaning and disinfection

-
- See company cleaning guidelines and see Section 6 "CLEANING".
-

7.2.4 Entire machine - Perform a wipe test

-
- Check the result of the cleaning and disinfection by means of a wipe test.
See company cleaning guidelines and see Section 6 "CLEANING".
-

7.2.5 Entire machine - Acidic cleaning and disinfection

-
- See company cleaning guidelines and see Section 6 "CLEANING".
-

7.2.6 Connections - Visual inspection

-
- Disconnect the machine from the mains electricity.
-
- Check power cable for damage.
-
- If present, check that the supply line for inert gas is fitted tightly and undamaged.
-

7.2.7 Vacuum pump - Checking oil level, topping up

-
- Check the oil level on the oil sight glass.
-
- If water is present in the oil, change the oil in the vacuum pump, see Section 7.6 "CHANGE THE OIL IN THE VACUUM PUMP".
-

-
- If necessary, refill oil, see Section 7.6.2 "FILLING THE VACUUM PUMP WITH OIL."
-

7.2.8 Vacuum pump - Oil change

- Change the oil in the vacuum pump, see Section 7.6 "CHANGE THE OIL IN THE VACUUM PUMP".
-

7.2.9 Vacuum pump - Exchanging the air de-oiling element

- Change the air de-oiling element, see Section 7.7 "CHANGE THE AIR DE-OILING ELEMENT".
-

7.2.10 Entire machine - Check the age

- Read the year of manufacture on the type plate.
 - If the machine is older than 19 years:
 - Shut down the machine.
 - Have the safety functions checked by MULTIVAC Service.
-

7.3 Replace the sealing bar

7.3.1 Remove the sealing bar

- Switch off the machine.
 - Disconnect the machine from the mains electricity.
 - Open the chamber lid. Open the chamber lid more than half way so that it remains open.
 - The chamber lid remains open in the middle position.
 - Let the sealing bar cool down.
-



-
- Pull out the sealing bar.
-

7.3.2 Install the sealing bar

- Disconnect the machine from the mains electricity.
 - Open the chamber lid. Open the chamber lid more than half way so that it remains open.
 - The chamber lid remains open in the middle position.
-

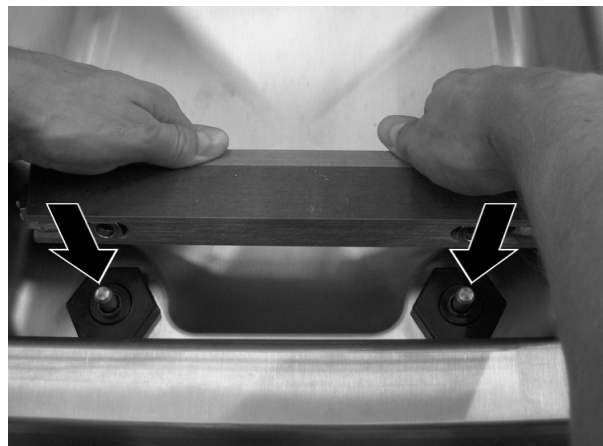

-
- Install the sealing bar on the carriers.
 - The screws on the sealing bar should point to the middle of the chamber.
-

7.4 Repair counter-pressure bar

- Open the chamber lid. Open the chamber lid more than half way so that it remains open.
 - The chamber lid remains open in the middle position.
-

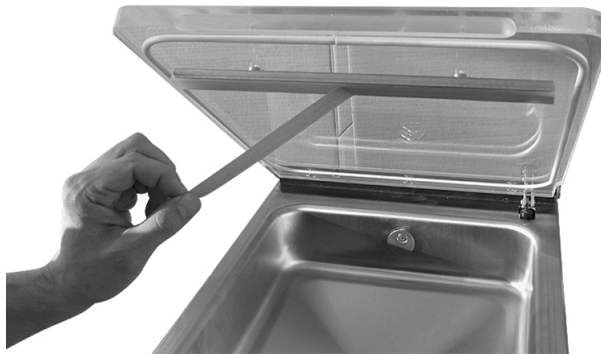

-
- Pull off the Teflon tape.
-

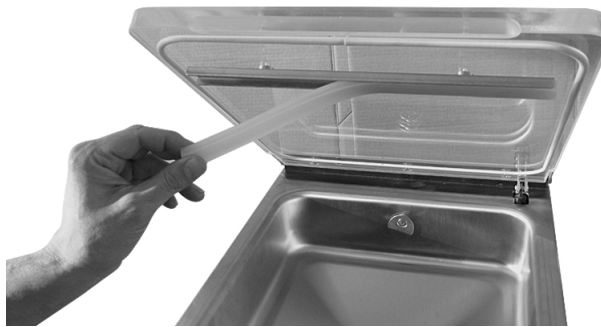

-
- Take the profile thread out of the counter-pressure bar.
 - Cut the Teflon tape to the length of the profile thread.
-



-
- Press the new profile thread into the counter-pressure bar.
 - Clean the profile thread.
 - The profile thread should be free of dirt and grease.
 - Stick the new Teflon tape onto the dry profile thread.
-



-
- Smooth the Teflon tape flat.
-

7.5 Open and close the housing

7.5.1 Open housing

-
- Open the chamber lid. Open the chamber lid more than half way so that it remains open.
 - The chamber lid remains open in the middle position.
 - Take all the objects out of the chamber apart from the sealing bar.
 - Close the chamber lid. So that the chamber lid remains closed, first open it as far as the limit stop and then close it.
-



-
- Unscrew the two screws at the rear of the machine. Turn these screws anticlockwise.
-



- Lay a soft underlayer in front of the machine.
 - When the housing is opened, the control terminal lies on the underlayer.
- Ensure that the machine is not connected to the mains electricity.

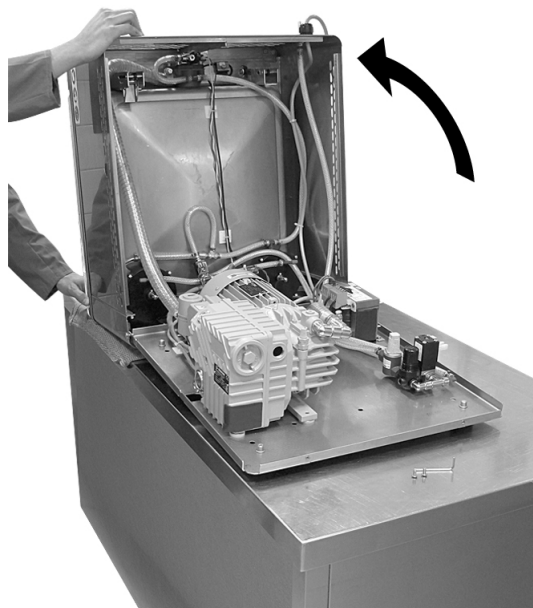

Burn hazard!

The surface of the vacuum pump can reach temperatures of over 70 °C during operation.

Touching the vacuum pump can lead to burns.

Before performing any work on the vacuum pump:

- Allow the vacuum pump to cool down.
- Wear personal protective equipment.

-
- Open the housing completely (slightly more than 90 °). Close the chamber lid and hold it closed when opening the housing.
 - The whole control terminal is lying flat on the underlayer.
 - The base plate of the machine is raised at the pivot point of the housing by several centimetres.
-

7.5.2 Close housing

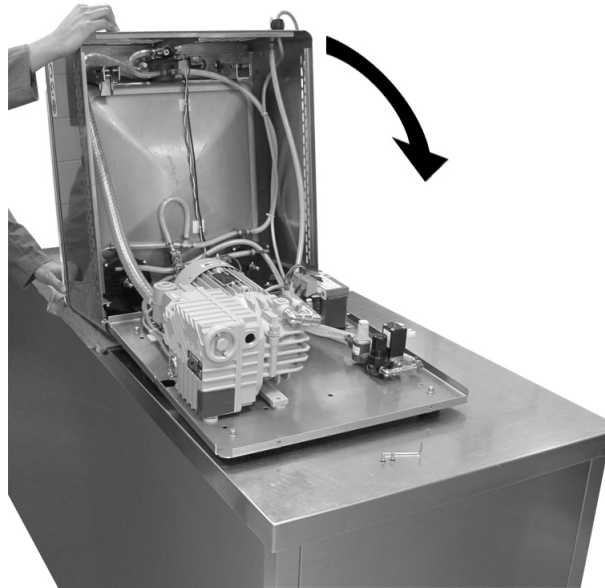

-
- Close the housing. Ensure that there are no cables between the housing and the base plate.
-



-
- Tighten the two screws at the rear of the machine. Turn these screws clockwise.
 - The housing is closed and tight.
-

7.6 Change the oil in the vacuum pump

7.6.1 Drain oil

- Allow the machine and vacuum pump to cool down for 1 hour.
 - Open housing, see Section 7.5.1 "OPEN HOUSING".
-

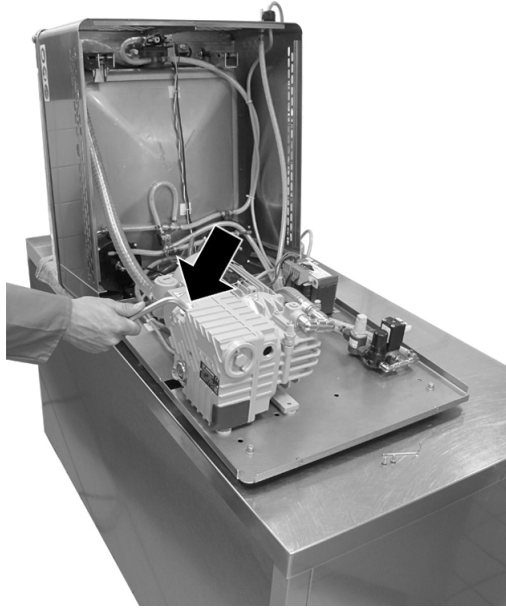

-
- Unscrew the screw plug. To do so, turn the screw plug anticlockwise.
-

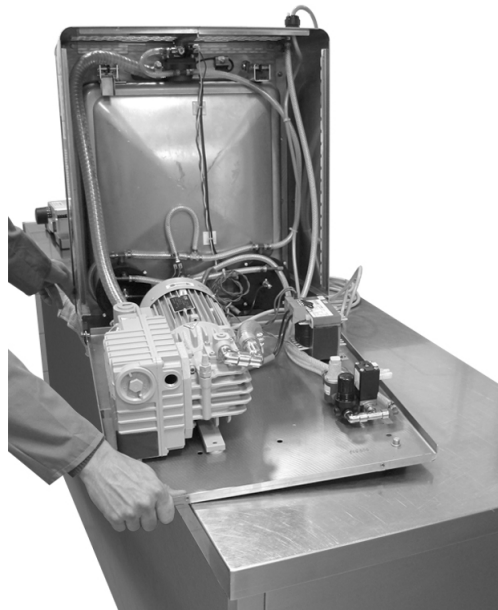

-
- Position the machine such that a liquid container can be held under the oil sight glass.
-



-
- Place filling plates under the base plate so that the base plate is even.
 - Hold the liquid container (e.g. an oil bottle) under the drain opening.
-



-
- Unscrew the screw plug. To do so, turn the screw plug anticlockwise.
-
- Drain the oil completely.
-
- Wipe off and remove any oil from the machine.
-
- Turn the screw plug in the drain opening and screw it tight. To do so, turn the screw plug clockwise.
-
- Dispose of old oil properly.
-
- Fill new oil into the vacuum pump, see Section 7.6.2 "FILLING THE VACUUM PUMP WITH OIL."
-
- Close housing, see Section 7.5.2 "CLOSE HOUSING".
-

7.6.2 Filling the vacuum pump with oil.

-
- Open housing, see Section 7.5.1 "OPEN HOUSING".
-

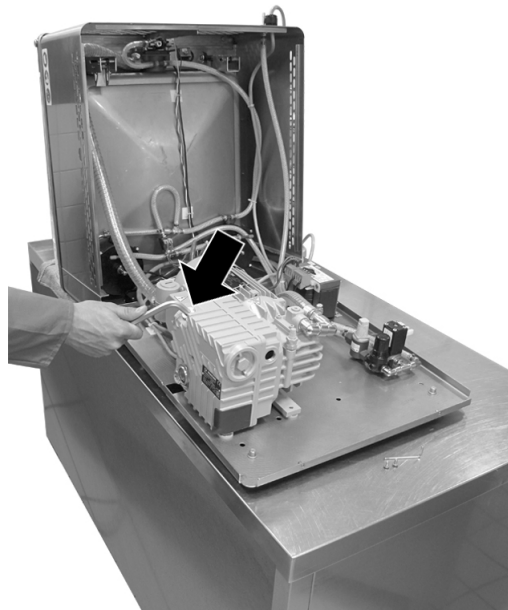

-
- Unscrew the screw plug. To do so, turn the screw plug anticlockwise.
-

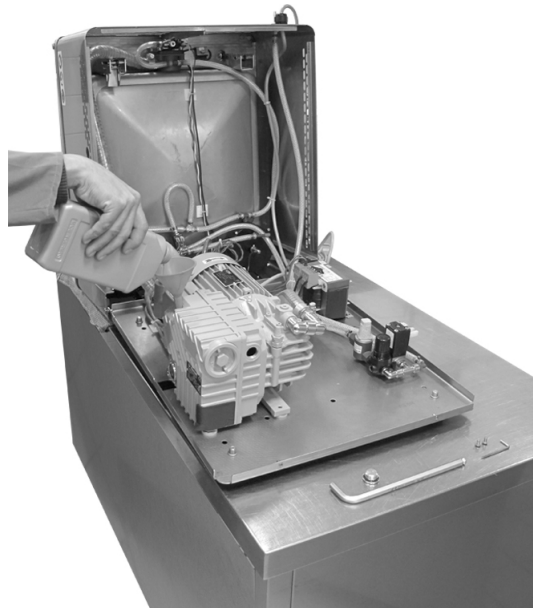

-
- Fill the vacuum pump with oil up to approximately the middle of the oil sight glass. Use only oils that are approved by the manufacturer, see 'Spare Parts' section or the spare parts catalogue.
-

**Info**

Only use low odour synthetic oil if food is being packed.

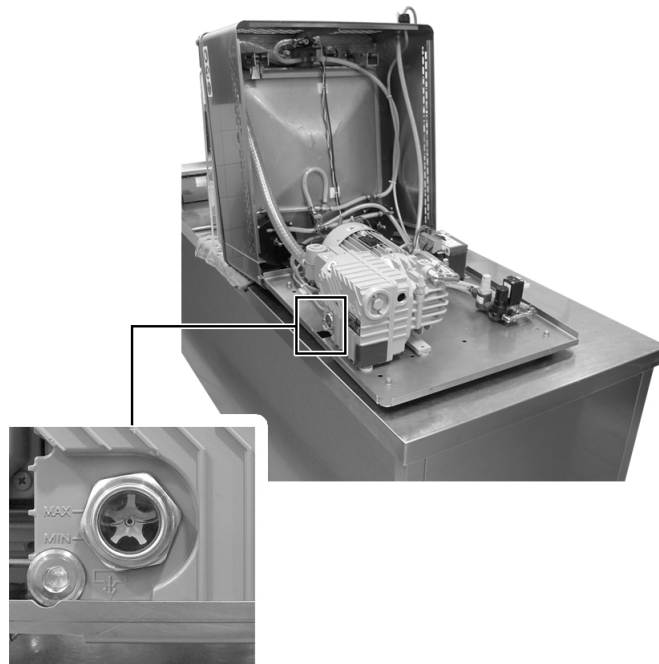

- Check the oil level on the oil sight glass.
 - The oil level is then approximately in the middle of the oil sight glass.
- Turn the screw plug in the fill opening and screw it tight. To do so, turn the screw plug clockwise.
- Wipe off and remove any oil.
- Close housing, see Section 7.5.2 "CLOSE HOUSING".
- Connect the machine to the mains electricity.
- Switch on the machine.
- Check the oil level after a couple of machine cycles.

7.7 Change the air de-oiling element

- Open housing, see Section 7.5 "OPEN AND CLOSE THE HOUSING".



Burn hazard!

The surface of the vacuum pump can reach temperatures of over 70 °C during operation.

Touching the vacuum pump can lead to burns.

Before performing any work on the vacuum pump:

- Allow the vacuum pump to cool down.
- Wear personal protective equipment.

-
- Allow the vacuum pump to cool down.
-

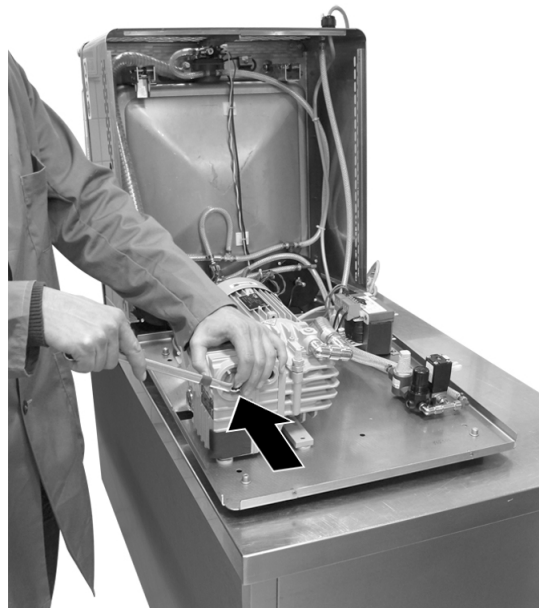

-
- Unscrew the screw plug. To do so, turn the screw plug anticlockwise.
-

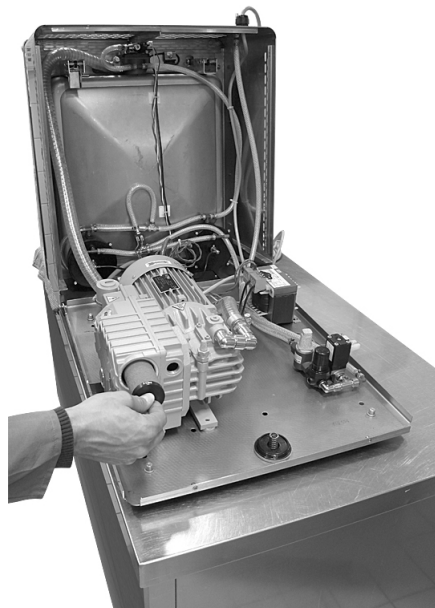

-
- Pull out the air de-oiling element and dispose of it properly.
-



-
- Attach a sealing ring to the new air de-oiling element.
-
- Insert a new air de-oiling element with sealing ring.
 - The arrow on the air de-oiling element points downwards.
-



-
- Place the screw plug, together with the spring, onto the air de-oiling element pipe and tighten it. To do so, turn the screw plug clockwise.
-
- Close housing, see Section 7.5 "OPEN AND CLOSE THE HOUSING".
-

7.8 Change chamber lid gasket

-
- Open the chamber lid as far as the limit stop and have a second person hold it.
-



-
- Remove the chamber lid gasket from the groove.
-

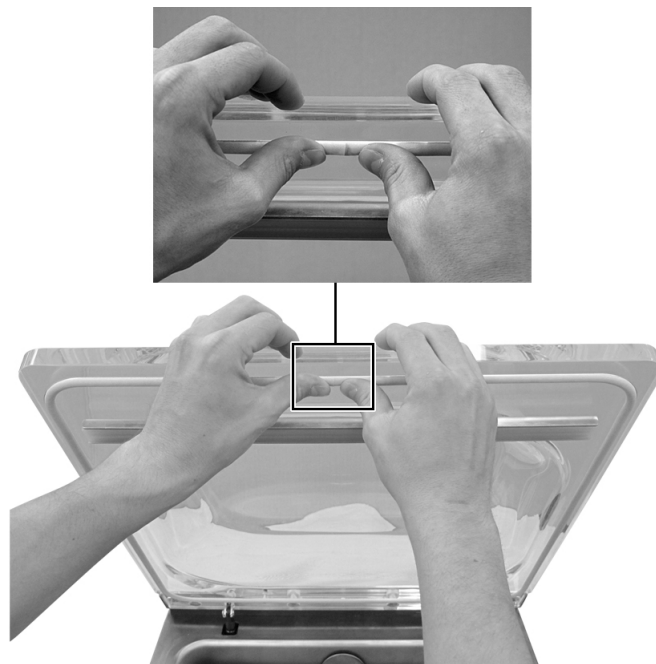

-
- Press the new chamber lid gasket into the groove of the chamber lid.
 - The beginning and end of the chamber lid gasket must butt up against each other without a gap.
 - During insertion, do not stretch the chamber lid gasket.
 - Smooth the chamber lid gasket flat.
-
- Check the chamber for leaks, see Section 7.9 "CHECK THE CHAMBER FOR LEAKS".
-

7.9 Check the chamber for leaks

- Switch on the machine.
-
- Press the <Evacuation> key.
-

-
- Set the evacuation time to 30 s with the <arrow keys>.
-
- To start the machine after it has been switched on, firmly press the opened chamber lid shut against the resistance by pressing the middle of its front edge.
-
- Pull the mains plug shortly before the evacuation time has elapsed.
-
- Observe the pressure display on the control terminal.
 - If the pressure climbs in one minute by less than a graduation mark on the black scale (0.02 bar): the chamber is not leaking.
 - If the pressure climbs in one minute by more than a graduation mark on the black scale (0.02 bar): the chamber is leaking.
-
- If the chamber is leaking, perform the following operations:
 - If the chamber lid gasket is wavy, smooth the chamber lid gasket flat.
 - If there is a gap between the beginning and end of the chamber lid gasket, remove the chamber lid gasket once more and install it again.
-

8 Troubleshooting



Injury hazard!

Ignorance of proper machine handling is very dangerous. Improper handling can lead to serious injuries.

For all service and repair work:

- Make sure you observe the safety instructions and accident prevention regulations.
- Disconnect the unit's power supply from the mains electricity.
- Only qualified electricians are permitted to work on electrical modules.
- Service and repair work should be carried out by authorised technicians only.

8.1 Faults with diagnostic message

Error	Symptom	Cause	Solution
E0	The chamber lid does not open after the packaging procedure.	• Gas strut is unhooked.	• Hook in the gas strut, for this open the chamber lid more than half way.
		• Ventilation valve does not open.	• Notify the service.
		• Machine control is defective.	• Notify the service.
E1	Chamber lid opens during the sealing process.	• The pressure difference between the chamber and the outside environment is not large enough before the sealing process.	• Set the evacuation time and gas flushing time such that the pressure display shows a pressure difference of at least 0.35 bar before the sealing process.

8.2 Faults without diagnostic message

Symptom	Cause	Solution
Machine does not run.	• Machine is switched off.	• Switch on the machine.
	• Mains plug is unplugged.	• Plug in the mains plug.

Symptom	Cause	Solution
	<ul style="list-style-type: none"> Ambient temperature too low. 	<ul style="list-style-type: none"> Operate the machine only at permissible ambient temperature, see "Technical Specifications".
	<ul style="list-style-type: none"> Vacuum pump defective. 	<ul style="list-style-type: none"> Notify the service.
Chamber lid does not remain closed despite pump running.	<ul style="list-style-type: none"> Chamber lid pressed closed too briefly. 	<ul style="list-style-type: none"> Press the chamber lid shut more evenly, more firmly and for longer.
	<ul style="list-style-type: none"> Chamber lid gasket is dirty. 	<ul style="list-style-type: none"> Clean the chamber lid gasket.
	<ul style="list-style-type: none"> Chamber lid gasket is damaged. 	<ul style="list-style-type: none"> Change chamber lid gasket.
The vacuum pump only runs for a very short period.	<ul style="list-style-type: none"> Evacuation time is set incorrectly. 	<ul style="list-style-type: none"> Increase evacuation time.
Poor vacuum in the pack.	<ul style="list-style-type: none"> Evacuation time is set incorrectly. 	<ul style="list-style-type: none"> Increase evacuation time.
	<ul style="list-style-type: none"> Gas flushing time is set incorrectly. 	<ul style="list-style-type: none"> Reduce the gas flushing time.
	<ul style="list-style-type: none"> Pouch neck is clamped by chamber lid. 	<ul style="list-style-type: none"> Insert the film pouch so that the pouch neck lies within the chamber. Cut off the pouch neck if necessary.
	<ul style="list-style-type: none"> Chamber lid gasket is dirty. 	<ul style="list-style-type: none"> Clean the chamber lid gasket.
	<ul style="list-style-type: none"> Insufficient oil quantity or oil in the vacuum pump is too old. 	<ul style="list-style-type: none"> Refill or replace oil.
	<ul style="list-style-type: none"> Chamber lid gasket is damaged. 	<ul style="list-style-type: none"> Change chamber lid gasket.
	<ul style="list-style-type: none"> Moist or liquid products give off steam during the evacuation process. 	<ul style="list-style-type: none"> Abort the evacuation process with the <Stop> key in case the chamber lid mists up.
	<ul style="list-style-type: none"> Evacuation system is leaking. 	<ul style="list-style-type: none"> Notify the service.
Pack is leaking.	<ul style="list-style-type: none"> Sealing time is set incorrectly. 	<ul style="list-style-type: none"> Increase the sealing time in small increments.
	<ul style="list-style-type: none"> Pouch neck is clamped by chamber lid. 	<ul style="list-style-type: none"> Insert the film pouch so that the pouch neck lies within the chamber. Cut off the pouch neck if necessary.
	<ul style="list-style-type: none"> Seal seam is dirty. 	<ul style="list-style-type: none"> Keep the inside of the film pouch in the area of the seal seam clean.

Symptom	Cause	Solution
	<ul style="list-style-type: none"> Film pouch damaged. 	<ul style="list-style-type: none"> Use a new film pouch.
	<ul style="list-style-type: none"> Film pouch not suitable. 	<ul style="list-style-type: none"> Use a film pouch suitable for sealing.
	<ul style="list-style-type: none"> The pressure difference between the chamber and the outside environment is not large enough before the sealing process. 	<ul style="list-style-type: none"> Set the evacuation time and gas flushing time such that the pressure display shows a pressure difference of at least 0.35 bar before the sealing process.
	<ul style="list-style-type: none"> Sealing bar damaged. 	<ul style="list-style-type: none"> Replace sealing bar.
Seal seam is uneven and wavy.	<ul style="list-style-type: none"> The pressure difference between the chamber and the outside environment is not large enough before the sealing process. 	<ul style="list-style-type: none"> Set the evacuation time and gas flushing time such that the pressure display shows a pressure difference of at least 0.35 bar before the sealing process.
	<ul style="list-style-type: none"> Teflon tapes on the sealing bar and counter-pressure bar are worn. 	<ul style="list-style-type: none"> Change the Teflon tapes.
	<ul style="list-style-type: none"> Profile thread in the counter-pressure bar is worn. 	<ul style="list-style-type: none"> Repair the counter-pressure bar.
Seal seam is milky.	<ul style="list-style-type: none"> Sealing time is set incorrectly. 	<ul style="list-style-type: none"> Reduce the sealing time. The seal seam should be clear and transparent.
The excess pouch neck can only be severed with difficulty at the sever seal or it can not be severed at all.	<ul style="list-style-type: none"> Sealing time is set incorrectly. 	<ul style="list-style-type: none"> Increase the sealing time in small increments. The excess pouch neck should be easy to sever.
	<ul style="list-style-type: none"> Sealing bar damaged. 	<ul style="list-style-type: none"> Replace sealing bar.
Odour or smoke.	<ul style="list-style-type: none"> Air de-oiling element is defective. 	<ul style="list-style-type: none"> Change air de-oiling element.
	<ul style="list-style-type: none"> Oil return valve of vacuum pump is clogged. 	<ul style="list-style-type: none"> Notify the service.
Machine is very loud.	<ul style="list-style-type: none"> Air de-oiling element clogged. 	<ul style="list-style-type: none"> Change air de-oiling element.
	<ul style="list-style-type: none"> Vacuum pump defective. 	<ul style="list-style-type: none"> Notify the service.
High oil consumption.	<ul style="list-style-type: none"> Air de-oiling element clogged. 	<ul style="list-style-type: none"> Change air de-oiling element.
Oil leaks out of machine.	<ul style="list-style-type: none"> Screw plugs or oil sight glass not tight. 	<ul style="list-style-type: none"> Tighten screw plugs and oil sight glass.
	<ul style="list-style-type: none"> Vacuum pump defective. 	<ul style="list-style-type: none"> Notify the service.

9 Shutdown, transport, storage



Info

Observe the safety instructions, see Section 1 "SAFETY".

9.1 Shutting down the machine

- Close the chamber lid.
- Close the stop-cock for the gas supply, if part of the machine.
- If present, remove the gas hose from the inert gas connection.
- Disconnect the machine from the mains electricity.
- Clean machine and then preserve it, see Section 6 "CLEANING".

9.2 Transporting the machine

9.2.1 Transporting the machine

- Wear personal protective equipment.



Injury hazard!

The machine is heavy.
Carrying the machine can cause injuries.

- Have a second person assist you.

NOTICE Danger of material damage!

At an inclination of more than 15°, the oil in the vacuum pump shifts.

The air de-oiling elements will get wet from the oil and become ineffective. This will damage the vacuum pump.

- Transport and set the machine down as horizontally as possible.
- Do NOT tilt the machine.
- Carefully raise the machine.
 - For machine dimensions and weight, see "Technical specifications".
- Transporting the machine
 - Avoid severe jolts.

9.3 Storing the machine

- Shutting down the machine.

 - Select a suitable storage site.
 - Observe the ambient conditions for storing the machine, see Technical specifications.
 - Ensure that the location site is of adequate load-bearing capacity and keep the weight of the unit in mind, see Technical specifications.

 - If necessary, cover the machine with film.
-

10 Disposal

10.1 Disposing of the machine



Info

- Sealing bars can be reused on other machines of the same series.
- If disposal of the machine is not handled by the manufacturer, dispose of the machine as described below.

-
- Disconnect the machine from the mains electricity, see Section 9 "SHUTDOWN, TRANSPORT, STORAGE".



Danger of explosion!

The gas strut on the chamber lid is under very high pressure. Opening the gas strut, or excessive heating of it, can lead to an explosion. Explosions can cause serious injuries or even death.

- Do NOT open the gas strut.
- Do not heat the gas strut excessively, see 'Technical Specifications'.
- Deposit the gas strut at a suitable collection point, or arrange for it to be disposed of by the manufacturer.

-
- Dispose of the materials properly, observing all legal and company-internal regulations regarding environmental protection.

10.2 Dispose of operating materials

10.2.1 Disposing of oil and grease

NOTICE Protect the environment!

Operating materials and working equipment are environmentally harmful.

Improper disposal is harmful to the environment.

- Handle operating materials and working equipment properly.
- Dispose of operating materials and working equipment at suitable collection points.
- Observe the environmental directives.

-
- Handle operating materials and working equipment properly and dispose of them in a professional manner.



Info

Excerpt from the disposal directive:

- It is prohibited to mix used oil with other waste.
- Used oils may NOT be mixed with each other.
- Used oil filters should be collected, stored, transported and disposed of separately from other waste.

10.2.2 Disposing of packaging materials



Info

Packaging materials are resource materials that can be recycled.

- Improper disposal is harmful to the environment.
- Films should be collected for recycling.
- Follow the disposal instructions of the packaging material manufacturer.

-
- Handle packaging materials properly and dispose of them in a professional manner.
-



Info

Packaging materials are resource materials that can be recycled.

- Improper disposal is harmful to the environment.
- Films should be collected for recycling.
- Follow the disposal instructions of the packaging material manufacturer.

10.2.3 Dispose of chemicals



Chemical burn hazard!

Cleansers are caustic. Caustic effects are NOT noticed immediately.

Contact with the skin can cause burns.

- Wear the prescribed personal protective equipment when handling cleansers.
- Observe the manufacturer's instructions.



Fire hazard!

Alcohol-based disinfectants are highly flammable.

Fire, naked light or smoking ignites the disinfectant and can thus cause fires.

- When disinfecting the machine, flames or naked lights are prohibited.
- Smoking is prohibited.
- Observe the instructions of the disinfectant manufacturer.

-
- Handle cleansers and disinfectants properly and dispose of them in a professional manner.
-



Info

Improper disposal is harmful to the environment.

- Observe the safety data sheets of the cleanser and disinfectant manufacturers.
- Follow the disposal instructions of the cleanser and disinfectant manufacturers.
- Observe regionally applicable disposal regulations.

11 Spare parts

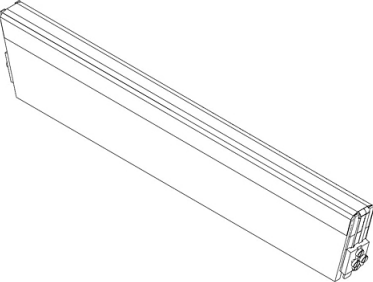
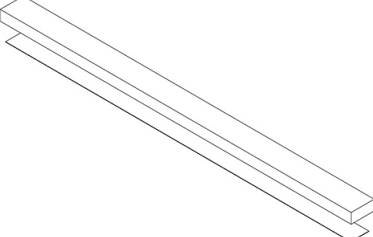
Illustration	Material number	Designation	Quantity and unit of measurement
 <p data-bbox="165 869 373 898">Fig. 14: Sealing bar</p>	106624708	Sealing bar (completely pre-assembled)	1 pc.
Not illustrated.	105311871	Teflon tape for sealing bar (for four changes)	1.8 m
 <p data-bbox="165 1308 547 1375">Fig. 15: Wearing parts set for counter-pressure bar</p>	106739631	Wearing parts set for counter-pressure bar Consisting of: <ul style="list-style-type: none"> • Profile thread. • Teflon tape. 	1 pc.
Not illustrated.	81848121001	Teflon tape for counter-pressure bar (for four changes)	2.0 m
Not illustrated.	105893127	Chamber lid gasket	1.91 m

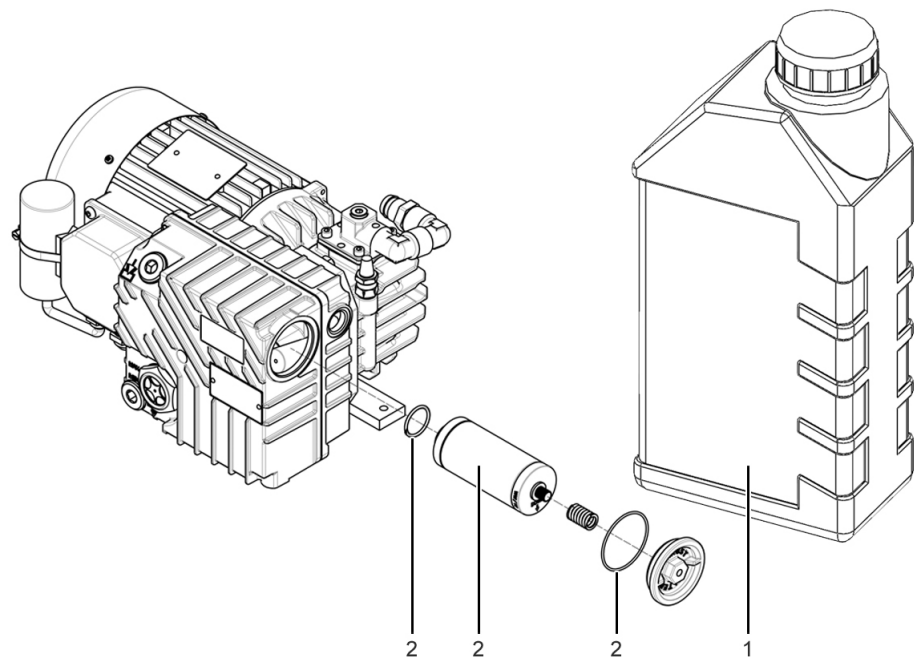

Fig. 16: Spare parts drawing for vacuum pump

- 1 Oil
- 2 Maintenance set

Item	Material number	Designation	Quantity and unit of measurement
1	105048117	Low odour synthetic oil for vacuum pumps	1 l
1	91111114013	HD oil mineral oil Not suitable for the packaging of food.	1 l
2	106701805	Wearing parts set Consisting of: <ul style="list-style-type: none"> • Air de-oiling element. • Sealing rings. 	1 pc.

MULTIVAC branch offices

GERMANY

MULTIVAC Sepp Haggenmüller GmbH & Co. KG
Tel.: +49 83 34 601 0
Fax: +49 83 34 601 199
multivac@multivac.de
www.multivac.com

SWITZERLAND

MULTIVAC EXPORT AG
Tel.: +41 41 785 65 65
Fax: +41 41 785 65 10
meag@multivac.ch
www.multivac.com

GERMANY

MULTIVAC Marking & Inspection GmbH & Co. KG
Tel.: +49 5224 931-0
Fax: +49 5224 931-299
multivac-mi@multivac.com
www.multivac.de

GERMANY

MULTIVAC Resale & Service GmbH
Tel.: +49 2157 8197 0
Fax: +49 2157 8197 22
info@multivacresale.de
www.multivac.de

ARGENTINA

MULTIVAC Argentina S.A.
Tel.: +54 11 4723 3766
Fax: +54 11 4723 4098
info@multivac.com.ar
www.multivac.com

AUSTRALIA

MULTIVAC Australia PTY. LTD.
Tel.: +61 3 8331 2800
Fax: +61 3 8331 2810
info@multivac.com.au
www.multivac.com

BELGIUM

Multivac N.V.
Tel.: +32 15 569 50 9
Fax: +32 15 569 50 1
mub@multivac.be
www.multivac.com

BRAZIL

MULTIVAC do Brasil
Tel.: +55 19 3795-0818
Fax:
nelson.dematos@br.multivac.com
www.multivac.com

BULGARIA

MULTIVAC Bulgaria EOOD
Tel.: +359 2 988-55-00
Fax: +359 2 988-55-88
service@bg.multivac.com
www.multivac.bg

CHILE

MULTIVAC CHILE S.A.
Tel.: +56 27 996 00 0
Fax: +56 27 996 00 1
mucl@cl.multivac.com
www.multivac.com

CHINA

MULTIVAC (Shanghai) Trading Co.
Building 7, Lane 195, Qianpu Road (Shanghai)
Tel.: +86 21 3701 8118
Fax: +86 21 3766 0051
info@cn.multivac.com
www.multivac.cn

DENMARK

MULTIVAC A/S
Tel.: +45 75 853 42 2
Fax: +45 75 853 45 4
mudk@multivac.dk
www.multivac.com

ESTONIA

MULTIVAC Oy Estonia Branch
Tel.: +372 622 8258
Fax: +372 622 8259
margus.kupp@ee.multivac.com
www.multivac.com

FINLAND

MULTIVAC Oy
Tel.: +358 20 792 13 00
Fax: +358 20 792 13 71
multivac@fi.multivac.com
www.multivac.com

FRANCE

MULTIVAC FRANCE S.A.S.
Tel.: +33 16 412 13 14
Fax: +33 16 412 75 30
muf@multivac.fr
www.multivac.com

GREECE

MULTIVAC Hellas Mepe
Tel.: +30 21 066 19 621
Tel.: +30 21 066 19 622
Fax: +30 21 066 19 662
info@gr.multivac.com
www.multivac.com

GREAT BRITAIN

MULTIVAC UK Ltd.
Tel.: +44 1793 425800
Fax: +44 1793 616219
sales@multivac.co.uk
www.multivac.com

INDIA

MULTIVAC Laraon India Private Limited
Tel.: +91 12 446 10 000
Fax:
info@multivac.co.in
www.multivac.com

IRELAND

MULTIVAC Ireland Ltd.
Tel.: +353 (0) 1 4133200
Fax: +353 (0) 1 4133205

www.multivac.com

ISRAEL

MULTIVAC B.P.S. Ltd.
Tel.: +972 46 344 68 1
Fax: +972 46 344 67 8
muil@multivac.co.il
il.multivac.com

ITALY

MULTIVAC Italia Service S.R.L.
Tel.: +39 02 450 32 08
Fax: +39 02 458 63 819
muit@it.multivac.com
www.multivac.com

JAPAN

Tokyo Foods Machinery Co. Ltd.
Tel.: +81 33 663 40 06
Fax: +81 33 662 49 41
t.orimi@tokyofoods.co.jp
www.multivac.com

CANADA

MULTIVAC Canada Inc.
Tel.: +1 905 264 1170
Fax: +1 905 264 9647
info@ca.multivac.com
www.multivac.com

COLUMBIA

Corporación MULTIVAC S.A.S. Oficinas
Tel.: +57 1 547 5241
Fax: +57 1 547 4276
info@co.multivac.com
www.multivac.com

CROATIA

MULTIVAC d.o.o.
Tel.: +385 14 855 20 5
Fax: +385 14 855 20 4
multivac@zg.t-com.hr
www.multivac.com

LATVIA

MULTIVAC Oy Latvia Branch
Tel.: +371 67 623 121
Fax: +371 67 622 602
girts.lazdins@lv.multivac.com
www.multivac.com

LITHUANIA

MULTIVAC Oy filialas Bukiškės
Tel.: +370 52 105 03 6
Fax: +370 52 336 41 3
donatas.margis@multivac.com
www.multivac.com

MEXICO

MULTIVAC Mexico S.A. de C.V.
Tel.: +52 55 502 05 555
Fax: +52 55 502 05 560
contacto@multivac.com
www.multivac.com

NEW ZEALAND

MULTIVAC New Zealand Ltd.
Tel.: +64 9 238-3055
Tel.: +64 2 146-0807
Fax: +64 9 238-3054
info@multivac.co.nz
www.multivac.com

NETHERLANDS

MULTIVAC BV
Tel.: (+31) 0348 436570
Fax: (+31) 0348 436580
munl@multivac.nl
www.multivac.com

NORTH AFRICA

MULTIVAC Afrique du Nord
Tel.: +216 71 963 963
Tel.: +216 71 860 128
Fax: +216 71 860 230
munaf@multivac.fr
www.multivac.com

NORWAY

MULTIVAC AS
Tel.: +47 33 445 25 0
Fax: +47 33 445 25 1
mun@multivac.no
www.multivac.com

AUSTRIA

MULTIVAC Vertriebsgesellschaft mbH
Tel.: +43 (0)1 698 1300
Fax:+43 (0)1 698 1300-99
info@multivac.at
www.multivac.com

ROMANIA

MULTIVAC Romania S.R.L
Tel.: +40 21 345 34 61
Fax:+40 21 345 34 61
adrian.dobre@multivac.ro
www.multivac.com

SERBIA

MULTIVAC d.o.o.
Tel.: +381 21 4721 144
Fax:+381 21 4721 146
info@multivac.rs
www.multivac.com

SPAIN

MULTIVAC Packaging Systems España, S.L.
E - 08396 Sant Cebrià de Vallalta (Barcelona)
Tel.: +34 902 290 909
Fax:+34 937 632 517
info@es.multivac.com
www.multivac.com

CZECH REPUBLIC

MULTIVAC Packing Machines, Ceska Republika S.R.O.
Tel.: +420 26 126 05 16
Fax:+420 26 126 05 18
mucz@cz.multivac.com
www.multivac.com

POLAND

MULTIVAC Sp. z o. o.
Tel.: +48 81 746 67 00
Fax:+48 81 746 67 01
mupl@multivac.pl
www.multivac.com

RUSSIA

MULTIVAC Rus / Moscow
127254 Moscow
Tel.: +7 495 604 4902
Fax:+7 495 604 4903
office@ru.multivac.com
www.multivac.com

SINGAPORE

MULTIVAC Pte. Ltd.
Tel.: +65 6565 3919
Fax:+65 6566 9798
David.Lum@sg.multivac.com
www.multivac.com

SOUTH AFRICA

MULTIVAC Southern Africa PTY. (LTD.)
Tel.: +27 16 340 5800
Fax:+27 16 340 5819
alex.ferguson@multivacsa.com
www.multivac.com

TURKEY

MULTIVAC Ambalaj Makineleri San. ve Tic. A.Ş.
Tel.: +90 216 526 00 33
Fax:+90 216 526 03 83
info@tr.multivac.com
www.multivac.com

PORTUGAL

Multi Vacuo - Sistemas de Embalagens Lda.
Tel.: +351 21 41 95 541
Tel.: +351 93 77 74 355
Fax:+351 21 41 95 543
diogo.magalhaes@pt.multivac.com
www.multivac.com

SWEDEN

MULTIVAC Sverige
Tel.: +46 311 70 0
Fax:+46 150 30 0
mus@multivac.se
www.multivac.com

SLOVAKIA

MULTIVAC Export AG organizačná zložka Slovakia Ges.m.b.H & Co. KG
Tel.: +421 24 446 40 70
Fax:+421 24 446 40 72
info@sk.multivac.com
www.multivac.com

SOUTH KOREA

MULTIVAC KOREA CO., LTD
Tel.: +82-70-4895-4041
Fax:+82-70-8244-4050
info@kr.multivac.com
www.multivac.com

UKRAINE

MULTIVAC Ukraine LLC
Tel.: +380 44 499 90 70
Fax:+380 44 499 90 67
office@ua.multivac.com
www.multivac.com

HUNGARY

MULTIVAC Hungária Kft.
Tel.: +36 23 500 28 7
Fax: +36 23 500 28 8
info@hu.multivac.com
www.multivac.com

USA

MULTIVAC, Inc.
Tel.: +800 877 5200
Tel.: +1 816 891 0555
Fax: +800 347 6164
Fax: +1 816 891 0622
muinc@multivac.com
www.multivac.com

UNITED ARAB EMIRATES

MULTIVAC Middle East (FZE),
Amir Sotoudeh
Tel.: +971 4 299 1980
Fax: +971 4 299 1981
amir.sotoudeh@ae.multivac.com
www.multivac.com