



REFRIGERATORS & FREEZERS

MANUAL OF INSTRUCTIONS FOR USE AND INSTALLATION





CONTENTS

- 1.** Transportation – Positioning – Installation
- 2.** Starting Up
- 3.** Safety Instructions
- 4.** Temperature Regulation
- 5.** Defrosting
- 6.** Temperature Alarm
- 7.** Fault codes on the display
- 8.** Cleaning & Maintenance
- 9.** Temporary Function Interruption
- 10.** Energy Saving Devices
- 11.** Troubleshooting
- 12.** Thermostats Instructions
- 13.** Electrical Diagrams
- 14.** Drain Assembly

1. Transportation – Positioning – Installation



Keep the appliance in an upright position during transportation in order to avoid critical damage to its systems

Remove all packaging. Move the unit carefully to its final position. If the floor is uneven, use the adjustable legs to level. If the floor is still not flat, adjust the legs so that the front side is approximately 1cm higher than the rear to ensure the doors will close and stay closed.



To ensure efficient operation do not place the unit near direct heat sources such as cookers, sunlight or radiators. The appliance is design to operate in temperatures no higher than 40 °C

Remove the power cord from the interior of the appliance. Power must be connected via a wall socket. The appliance is supplied with a UK compliant 2 pin electric plug.



Current taps and plugs must always be suitably earthed

If the device has a showcase, remove the small wrapping cartons underneath the glass and carefully move the side glasses unscrewing the screws illustrated in the diagram below so they line up with the front glass of the showcase

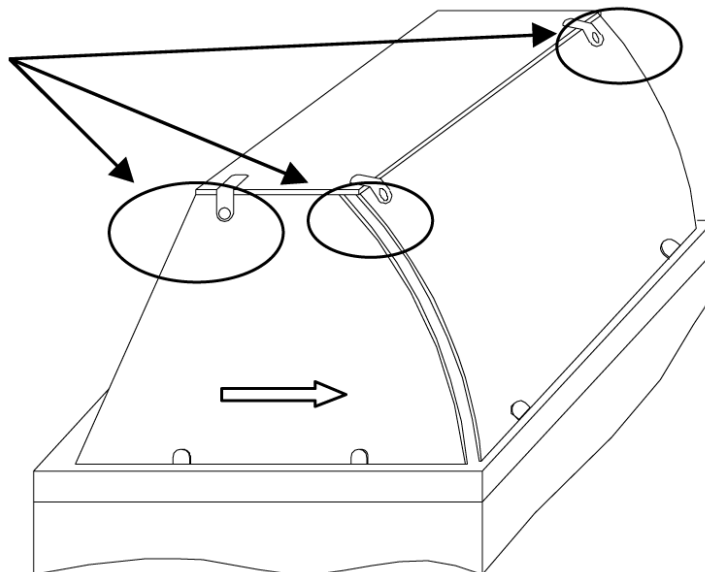

2. Starting Up

Press the On/Off switch. The figure that is showing in the display is the actual current temperature of the cabinet and indicates that the power is connected. The motor should start after 2 minutes



Do not store products in the appliance until its temperature reaches the required point. Do not overfill the cabinet or restrict the flow of air.

3. Safety Instructions

For your safety, and for efficient operation of the appliance, please follow these instructions carefully:

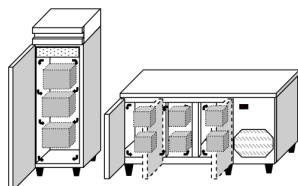

Store all products in such a way so as not to obstruct the airflow around the counter



Do **NOT** store hot food or drinks inside the appliance

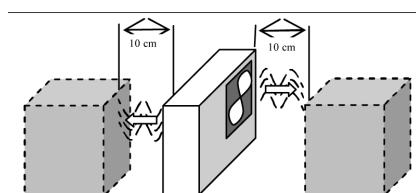

Place products at least 10cm away from the fan, otherwise the refrigeration in the appliance will be impaired

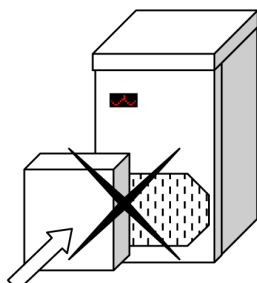

Do **NOT** cover the intake slots









Cover the food with a plastic film before storing it in the appliance



Do **NOT** operate pizza refrigerated showcase without gastronorm pans covering the whole cooling space.

4. Temperature Regulation

Refrigerators: Press  to see the temperature setting. If you wish to adjust this, keep this key pressed and change it by pressing the arrows  or  accordingly.

Freezers: Press  and **[SET]** to see the temperature setting. If you wish to adjust this, press the arrows  or  accordingly.

5. Defrosting

Refrigerators: Defrosting is automatically performed **4** times over **24** hours. (-2/+8 series **8** times every **24** hours). It can also be performed manually by pressing the **[SET]** key. If the refrigerator is on heavy load conditions (frequent door opening) manual defrosting may become necessary. Condensate water is led through the tube to a tray, where it is evaporated by means of a pipe from the refrigeration system placed in an evaporation tray (refrigerated counters, saladettes), or it is led through a tube to the drainage kit, where it is evaporated by a heater, controlled by the water level (upright refrigerators).

Freezers: Defrosting is automatically performed **4** times every **24** hours. It can also be performed manually by pressing the **[SET]** key. If the freezer is operating on heavy load conditions, manual defrosting may be necessary. Condensate water is led through a tube to the drainage kit, where it is evaporated by a resistance, controlled by the water level.

6. Temperature Alarm (Freezers)

If the temperature in the appliance is higher or lower than the limits set the an 'ALR' indication flashes on the display. Filling with large quantities of stock at once, or leaving the door open for a prolonged period will cause the temperature to rise and activate the alarm.

7. Fault Codes on the Display

7.1 Refrigerators

[F1]: Sensor Failure. If the sensor Fails, the compressor remains on for 4 Minutes and off for 4 mins. Technical Assistance should be sought.

7.2 Freezers

[ALO] Low temp. alarm
[AHI] High temp. alarm
[LF1] Temp. sensor failure
[LF2] Evap. Sensor failure
[doR] Door opened

Alarm codes are also audible (freezers)

8. Cleaning & Maintenance

Frequent cleaning of the appliance is highly recommended. Do not use sharp or abrasive cleaning products such as wire wool, scrapers etc, as these may damage the appliance. Clean the inside surfaces with a mild solution of warm water and a neutral detergent which does not contain chlorine. You may also clean the exterior surfaces with steel oil.



Do NOT use detergents or substances that are based on chlorine or acid solvents. These may cause corrosion of stainless steel surfaces

Keep the compressor and the condenser free from dust and dirt, otherwise the efficiency of the refrigerator will be reduced. Cleaning is best done with a vacuum cleaner and a brush.



Before you begin any cleaning or maintenance, ensure the appliance is disconnected from the power supply.

9. Temporary Function Interruption

In the event of turning the appliance off for an extended period it is important that the appliance is completely unloaded and disconnected from the power supply. Once this is finished, clean the appliance following the previous guidance and leave the doors slightly open to avoid any odours building up inside the cabinet.

10. Energy saving Advice

- Avoid unnecessarily opening and closing the doors as this may raise the temperature inside the cabinet, it is best to keep the doors closed as much as possible.
- Check the door seals of your appliance regularly to ensure they are sealing the cabinet and are in good order, much energy is wasted through faulty and worn door seals
- Do not place your cabinet close to any direct heat sources such as cookers, radiators, direct sunlight etc. This will cause the appliance to work harder to maintain a cool temperature
- Do not overfill the appliance, as this will restrict the air flow around the cabinet, taking it longer to reach the desired low temperature.

11. Troubleshooting

PROBLEM	POSSIBLE CAUSE	SUGGESTION
<i>The appliance does not cool</i>	<ul style="list-style-type: none"> • Ice on the evaporator • Products obstructing air flow • Room temp is very high 	<ul style="list-style-type: none"> • remove anything obstructing the air flow to the evaporator • Improve the ambient temperature
<i>Ice on the evaporator</i>	<ul style="list-style-type: none"> • Temp is set too low (refrigerator.) • High humidity environment • Humid products placed in refrigerator. (Vegetables, etc.) • Doors opened too frequently or left open 	<ul style="list-style-type: none"> • Check temp adjustment • Increase temp. setting • Improve the ambient conditions • Cover humid foods with a plastic film • Increase defrost frequency • Restrict door opening
<i>Water in the appliance</i>	The drainage pipe has been sealed	Clean the drainage pipe
<i>Water in gast. Pans (open top refrig.)</i>	High humidity environment	Increase the setting temperature

In case of any malfunction, contact your dealer, describing the problem, making note of your serial number and model of your appliance. This can be found on the rating plate shown on the next page.

RATING PLATE

All the technical characteristics necessary are shown as below and can be found usually to the right hand side of the appliance.

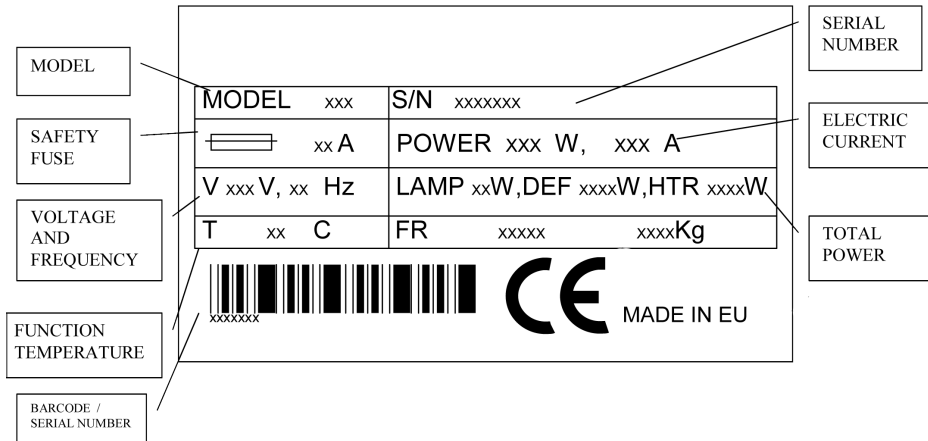

For spare or replacement parts for this appliance, please scan the QR code below with your smartphone or other reader or visit www.pentlandparts.co.uk



Inomak Parts

Alternatively telephone **01254 614488** and talk to an advisor to ensure you are ordering the correct part.



INOMAK appliances are brought exclusively to the UK by Pentland Wholesale Ltd
www.Pentlandwholesale.co.uk

Technical Information for Service Engineers

This following section provides controller instructions and technical diagrams for equipment installers and engineers

Controller Instructions

THERMOSTAT KIOUR - FR (FREEZERS)

Operating instructions

- 1) Push [**•**] to enter the parameters menu. The first parameter (SPo) shows up. Scroll the parameter list by pressing key [**▼**] or [**▲**].
- 2) Press [**set**] to display a parameter value and modify it by pressing the arrows. Press [**•**] to save the new value.
- 3) To exit the parameter menu press [**•**].
- 4) On/off switch: Press  for 3 seconds to switch the device off.
- 5) T2 (▲): Press to see the evaporator temperature.
- 6) Reset (▼): In case of alarm situation, press to reactivate.
- 7) Df (set): Press [**set**] for 4 seconds to start a manual defrost cycle.
- 8) Network connection: The thermostat can be connected on a network (RS485 Modbus protocol) through interface.

Alarm messages:

ALo: Low temperature alarm AHl: High temperature alarm

LF1: Room sensor failure LF2: Evaporator sensor failure



Dor: Open door alarm (when a door remains more than four minutes opened)

PARAMETER SETTINGS

	Code	Description	Minimum - Maximum Limits	Settings (Freezers)	Settings (-2 +8°C)
1	SPo	Temperature setpoint	LSP . . . HSP	-18	-2
2	ALo	Low alarm threshold	-45 . . . 20°C	-25	-5
3	AHl	High alarm threshold	0 . . . 60°C	0	8
4	Dr1	Defrost repetition time	1 . . . 100 h	6	3
5	Cod	Access code		22	22
6	DiF	Thermostat delay	1 . . . 20°C	2	3
7	dd2	Defrost time out	0 . . . 100 min	30	15
8	dP3	Dripping time	0 . . . 15 min	2	2
9	dY4	Defrost display control	-1 . . . 40 min (-1: Displays Dfr while t>Sp0+dif)	-1	-1
10	dE5	Defrost end temperature	1 . . . 70°C	30	15
11	DI6	Defrost type	0= ELE / 1=GAS	0	0
12	AF1	Alarm setting	0=Auto, 1=Manual	0	0
13	At2	Temperature alarm delay	-1 . . . 120 min (-1: alarm disabled)	30	15
14	Fo1	Fan restart temperature	-50 . . . 50°C	-2	10
15	Ft2	Evaporator fan control	-1: Continuous function 0: Parallel with compressor 0-15 min: time fan stops after compressor	-1	-1
16	Fd3	Ventilation in defrost	0: off 1: Starts when t2<Fo1 2: on	0	0
17	Co1	Compressor minimum on time	0 . . . 15 min	2	2
18	Cp2	Compressor minimum off time	0 . . . 15 min	2	2
19	CF3	Compressor control for T1 fault	-1: compressor off 0: compressor on 1-150 min: compressor on time	3	3
20	CF4	Compressor off time for T1 fault	1-150 min	3	3
21	SE1	Probe T1 offset	-20 . . . 20°C		
22	SE2	Probe T2 offset	-20 . . . 20°C		
23	SEr	-		0	0
24	LSP	Minimum temperature setting	-50 . . . 100°C	-21	-2
25	HSP	Maximum temperature setting	-50 . . . 100°C	-10	8
26	CF	Alter temperature measurement unit (changing the unit will not affect setpoint and limit values – these values must be changed manually)	0 = 0°C, 1 = 0°F	0	0
27	Br	Baud Rate (9600)	1 10	1	1
28	tr	Response time on network (mSec)	5 . . . 20 msec	20	20
29	Ad	Network address	0 . . . 255	2	2

Refrigerator controller

Operating instructions

1. Press [**set**] + [**▼**] + [**▲**] to enter the parameters menu. The first parameter (SP) shows up. Scroll the parameter list by pressing key [**▼**] or [**▲**].
2. Press [**set**] to display a parameter value and modify it by pressing the arrows. Press [**•**] to save the new value.
3. To exit the parameter menu press [**•**].
4. On/off switch: Press  for 3 seconds to switch the device off.
5. Reset (**▼**):  In case of alarm situation, press to reactivate.
6. Defrost: Press key [**set**] for 4 seconds to start a manual defrost cycle.
7. Network connection : The thermostat can be connected on a network (RS485 Modbus protocol) through interface.
8. To reduce the relative humidity, set the parameter FF = 0.

Alarm messages:

F1: Room sensor failure

Er: Memory fault. Proceed with the following:

- 1) Press buttons [**•**] and [**▲**].
- 2) Set the thermostat's parameters as described in the instructions manual.

PARAMETER SETTINGS

	Code	Description	Minimum - Maximum Limits	Factory settings (saladette)	Factory settings for pizza showcase
1	SP	Temperature setpoint	LSP . . . HSP	0 (3)	3
2	SL	Minimum temperature setting	-50 . . . 100 °C	-2 (0)	3
3	Sh	Maximum temperature setting	-50 . . . 100 °C	8 (10)	7
4	Di	Thermostat delay	1 . . . 8 °C	3	3
5	Cr	Compressor off time	0 . . . 4 min	2	1
6	CF	Compressor control for sensor fault	0= 40%: 3min on & 4 min off 1=100%: compressor on	0	0
7	dF	Defrost repetition time 24h	0 . . . 12	4	0
8	dt	Defrost time out	1 . . . 90 min	18	18
9	dL	Defrost end temperature	1 . . . 20 °C	10	10
10	do	Defrost type	Electric / compressor off	0	0
11	dr	Dripping time	0 . . . 10 min	0	0
12	Td	Display in defrost	0 . . . 99 min	20	20
13	AJ	Probe T1 offset	-9 . . . 10 °C		
14	tS	Display slowdown	0 . . . 20 sec	0	0
15	FC	Measurement Unit (°C / °F)	0 = °C, 1 = °F	0	0
16	Br	Baud Rate (9600)	1...10		
17	tr	Response time on network (mSec)	5 . . . 20 msec	20	20
18	FF	Evaporator Fan control	0 = start/stop with compressor, 1 = always On	1	1
16	Ad	Network address	0 . . . 99	2	2

Electrical Diagram for Refrigerators

ELECTRIC DIAGRAM FOR POSITIVE REFRIGERATORS (KIOUR – DF)

1 & 2. TEMPERATURE PROBE, 3 & 4. WATER LEVEL CTRL, 6. LIVE, 8.NEUTRAL, 9. COMPRESSOR, 10.EVAPORATOR FANS (LIGHT), 11.TRAY HEATER

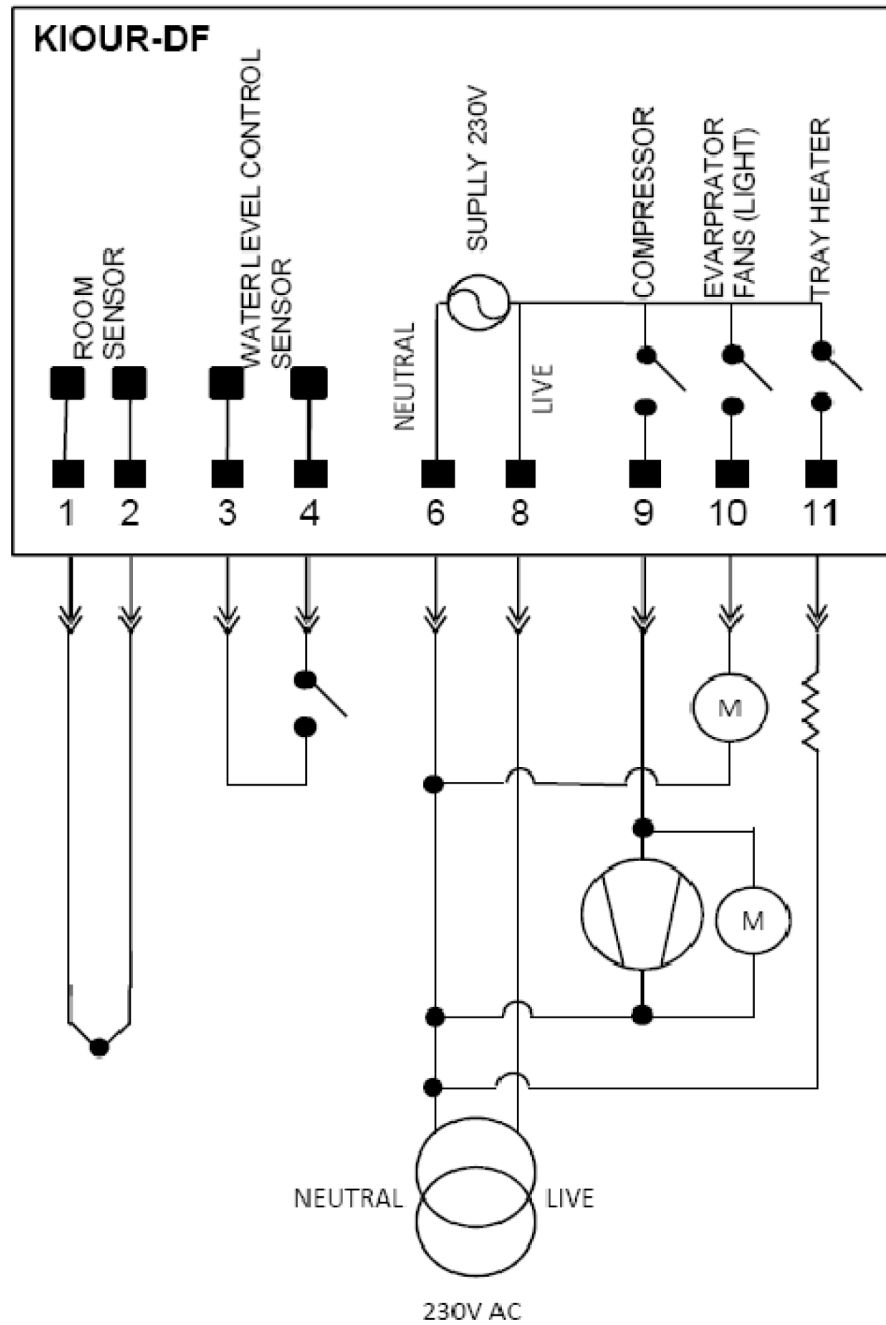

Electrical Diagram for Freezers

ELECTRIC DIAGRAM FOR FREEZERS (KIOUR – FR)

1. EVAPORATOR PROBE, 2. ROOM PROBE, 3. SENSORS COMMON, 4. LEVEL CONTROL, 5. DOOR SWITCH, 6. & 7. 12V INPUT, 8. DOOR FRAME HEATER (Transformer 230 to 12V), 9. COMPRESSOR, 10. COMMON LIVE, 11. DEFROST HEATER, 12. TRAY HEATER, 13. EVAPORATOR FANS

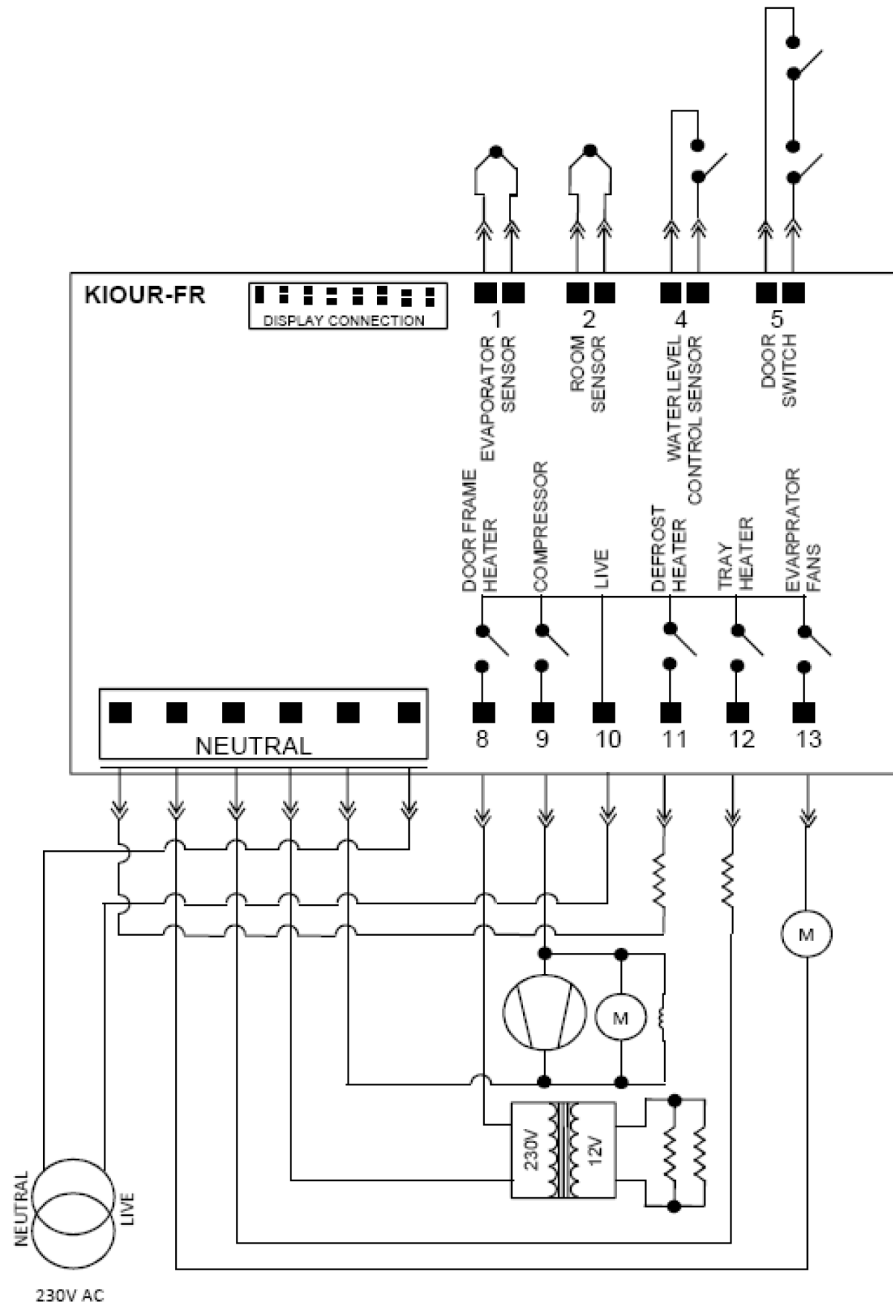

Drain Siphon Assembly (Uprights)

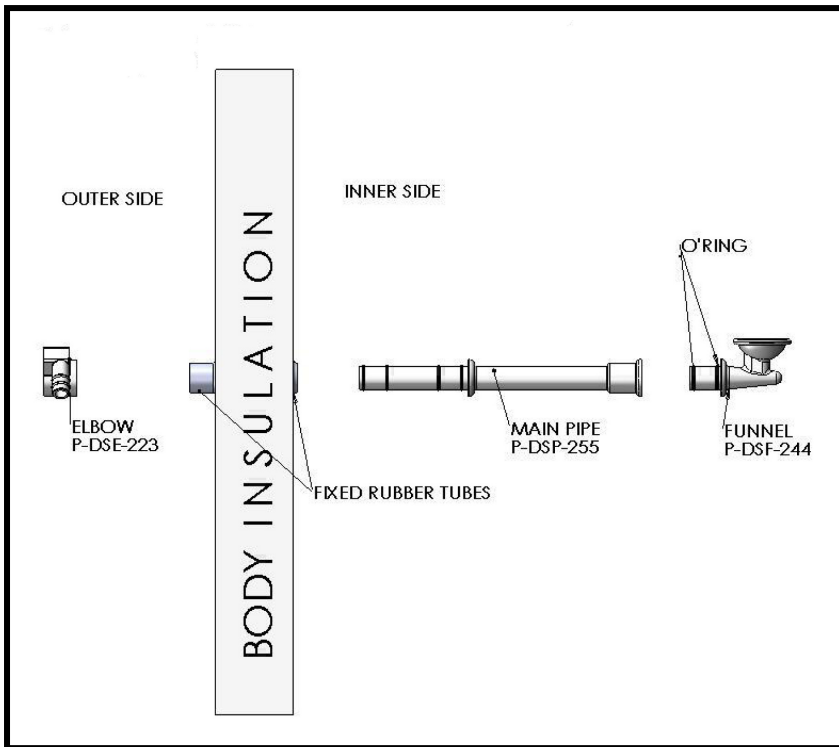

Drain Siphon Assembly (Counters)

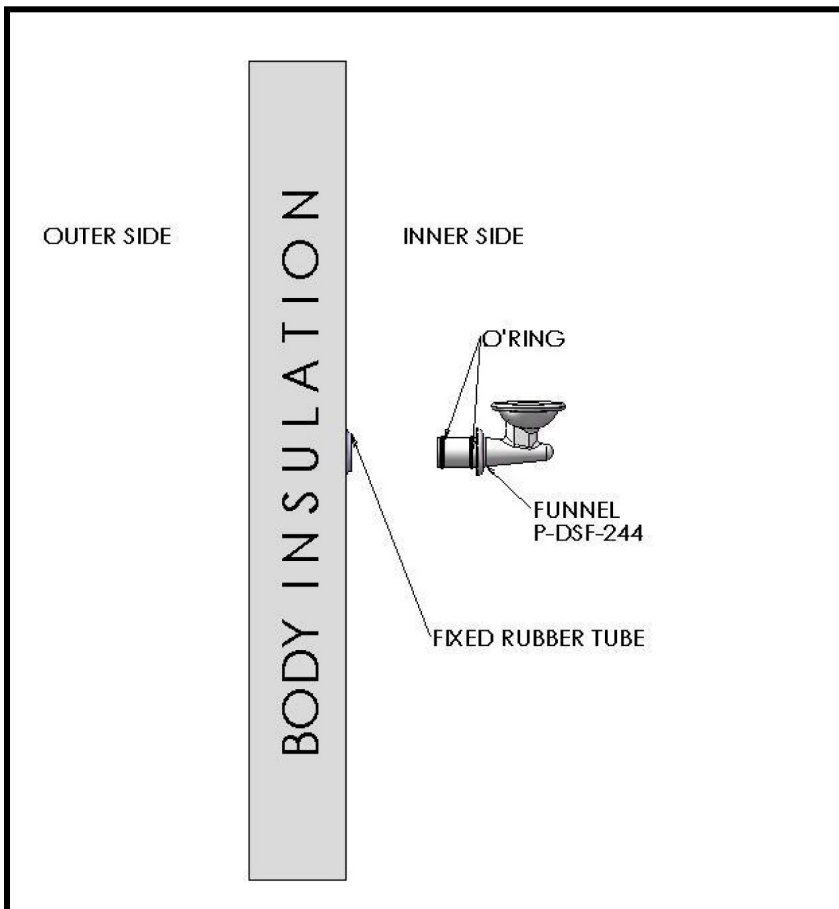

Temperature Sensor Cover Removal
Pull the sensor out of the cover and turn the cover anti-clockwise

