



## L6012WB - Lincat Free-standing Wall Bench - W 1200 mm

Prepare delicious dishes with confidence on this strong, reliable Lincat Wall Bench.

- ✓ The high quality 304 grade stainless steel surfaces resist corrosion & easy to clean – maintaining a hygienic working space
- ✓ Quick and simple to assemble
- ✓ Features undershelves for maximum space
- ✓ Sound deadening design – reduces noise, by dulling the sounds of impact
- ✓ Adjustable feet that create a level working surface
- ✓ Supplied flat packed for safe and economic transportation

### Specifications

#### Summary

<b>Brand</b>	Lincat
<b>Range</b>	Specialist
<b>Unit Type</b>	Free-standing
<b>Available in UK Only</b>	No
<b>UK Warranty</b>	2 Years Parts and Labour Warranty
<b>Export Warranty</b>	Contact your local dealer
<b>GTIN</b>	5056105101895

#### Key Specifications

<b>Number of Shelves included</b>	1
<b>Number of Shelf Positions</b>	1

#### Weights and Dimensions

<b>Unit Height (External) mm</b>	960
<b>Unit Width (External) mm</b>	1200
<b>Unit Depth (External) mm</b>	600
<b>Shelf Dimensions Width mm</b>	1050
<b>Shelf Dimensions Depth mm</b>	450
<b>Net Weight Kg</b>	20.5

#### Shipping

<b>Packed Weight Kg</b>	30.5
<b>Packed Height cm</b>	32
<b>Packed Width cm</b>	120
<b>Packed Depth cm</b>	80

### Technical Picture

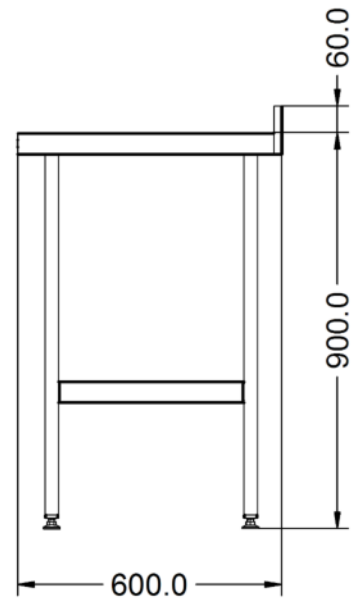
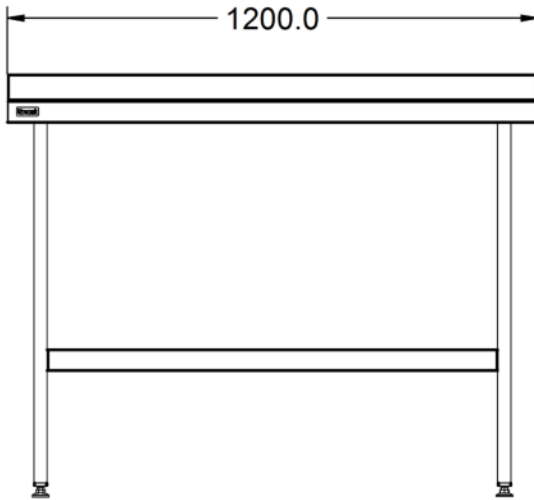

**Lincat Limited**

Whisby Road,  
Lincoln, LN6 3QZ,  
United Kingdom

**Company No:** 2175448

A member company of



**Customer Care**

**Tel:** +44 1522 875500  
**Email:** care@lincat.co.uk

**Export Customers**

**Tel:** +44 1522 503250  
**Email:** export@lincat.co.uk

**Opening Hours**

**Monday – Friday:**  
8.30am – 5pm