

# BURCO

## COMMERCIAL

### **Users Guide & Installation Handbook**

# CONTENTS & INTRODUCTION

---

## CONTENTS

- SAFETY
- USING THE PRODUCT
- CLEANING
- INSTALLATION INSTRUCTIONS
- TECHNICAL DATA
- CUSTOMER CARE

## INTRODUCTION

### **Thank you for buying this British-built appliance from us.**

This guide book is designed to help you through each step of owning your new cooker, from installation to use. Please read it carefully before you start using your product, as we have endeavored to answer as many questions as possible, and provide you with as much support as we can.

If, however, you should find something missing, or not covered, please contact our Customer Care team. Their number is located on the back page of this book.

For customers outside the UK and Northern Ireland, please contact your local supplier.

When you dial this number you will hear a recorded message and be given a number of options. This indicates that your call has been accepted and is being held in a queue. Calls are answered in strict rotation as our Customer Care representatives become available.

Alternatively, general information, spares and service information is available from our website. The address is located on the back page of this book.

## WARRANTY

Your new appliance comes with our 3-years parts and 1 years labour guarantee, protecting you against electrical and mechanical breakdown. To register your appliance please call **0844 815 3742**, complete the registration form included or register online at the web address located on the back page of this book.

For full terms & conditions of the manufacturer's guarantee, refer to the website on the back of this book.

In addition, you may wish to purchase an extended warranty. A leaflet explaining how to do this is included with your appliance.

Our policy is one of constant development and improvement, therefore we cannot guarantee the strict accuracy of all of our illustrations and specifications - changes may have been made subsequent to publishing.

## **GAS WARNING**

### **If you smell gas:**

**Do not try to light any appliance.**

**Do not touch any electrical switch.**

**Call the Gas Emergency Helpline at  
TRANSCO on: 0800 111999**

# SAFETY

---

## BEFORE USING THE PRODUCT

Make sure that you have removed all packaging and wrapping. Some of the items inside this appliance may have additional wrapping.

It is advised that you turn the ovens and/or grill on for a short while. This will burn off any residues left from manufacturing. There may be a smell which accompanies this process - but this is nothing to worry about and is harmless.

It is recommended that you wash the oven shelves, baking tray, grill pan and grill pan trivet before their first use in hot soapy water. This will remove the protective oil coating.

**WARNING:** - The appliance and its accessible parts may become hot during use. Care should be taken to avoid touching heating elements. Children less than 8 years of age shall be kept away unless continuously supervised.

This appliance can be used by children aged 8 years and above and persons with reduced physical, sensory or mental capabilities or lack of experience and knowledge if they have been given supervision or instruction concerning use of the appliance in a safe way and understand the hazards involved. Children should not play with the appliance. Cleaning and maintenance shall not be made by children with-

out supervision.

**WARNING:-** Servicing should be carried out only by authorised personnel.

The appliance must never be disconnected from the mains supply during use, as this will seriously affect the safety and performance, particularly in relation to surface temperatures becoming hot and gas operated parts not working efficiently. The cooling fan (if fitted) is designed to run on after the control knob has been switched off.

This appliance is for cooking purposes only. It must not be used for other purposes, for example room heating.

# SAFETY

---

## GENERAL

The appliance must never be disconnected from the mains supply during use, as this will seriously affect the safety and performance, particularly in relation to surface temperatures becoming hot and gas operated parts not working efficiently. The cooling fan (if fitted) is designed to run on after the control knob has been switched off.

Do not spray aerosols in the vicinity of this appliance while it is in operation.

Do not store or use flammable liquids or items in the vicinity of this appliance.

Do not modify this appliance.

## OVEN/GRILL

### Do

- Always take care when removing food from the oven as the area around the cavity may be hot.
- Always use oven gloves when handling any utensils that have been in the oven as they will be hot.
- Always make sure that the oven shelves are resting in the correct position between two runners. Do not
- place the oven shelves on top of the highest runner, as this is not stable and can lead to spillage or injury.
- Always use the Minute Minder (if fitted) if you are leaving the oven unattended - this reduces the risk of food burning.

### Do Not

- Never place items on the door while it is open.
- Never wrap foil around the oven shelves or allow foil to block the flue.
- Never drape tea towels near the oven while it is on; this will cause a fire

hazard.

- Never pull heavy items, such as turkeys or large joints of meat, out from the oven on the shelf, as they may overbalance and fall.
- Never use this appliance to heat anything other than food items and do not use it for heating the room.
- Do not spray aerosols in the vicinity of this appliance while it is in operation.
- Do not store or use flammable liquids or items in the vicinity of this appliance.
- Do not modify this appliance.

## GAS HOB

### Do

- Always ensure that pan bases are dry and flat before using them on the hob.
- Always position pans over the centre of the heat zone, and turn the handles to a safe position so they cannot be knocked or grabbed.
- Always use pans which are no smaller than 100mm (4"), or larger than 250mm (10").
- Always match the size of pan to the heat zone – do not use large pans on small zones or vice versa.
- Always make sure that the burner caps, rings and pansupports are correctly placed. This will prevent pans becoming unstable while in use and ensure an uninterrupted gas flow.

# SAFETY

---

## GAS HOB

### Do Not

- Never use double pans, rim-based pans, old or misshapen pans, or any pan that is not stable on a flat surface.
- Never leave cooking fat, or oil, unattended.
- Never use commercial simmering aids, or heat diffusers, as they create excessive heat and can damage the surface of the hob.
- purpose than cooking food.
- Plastic cooking utensils can melt if they come into contact with a warm hob. Never leave them close to, or on top of the hob.
- Never use the hob for any other Never leave any heat zone alight without a pan covering it. This causes a fire hazard.
- Never leave an empty pan on a heating zone.
- Never leave anything lying on the hob.
- Never heat a sealed tin of food, as it might explode.
- Never use the hob surface for storage.

## FIRE SAFETY ADVICE

Most kitchen fires occur when people are distracted or leave things unattended, so remember:

If you're called away from the cooker - by the phone or someone at the door, either take pans off the heat, or switch off your hob.

Don't let yourself be distracted while cooking.

If you do have a fire in the kitchen, don't take any risks - get everyone out of your home and call the Fire Brigade.

### If a pan catches fire:

- Do not move it - it is likely to be extremely hot.
- Turn off the heat if it's safe to do so - but never lean over a pan to reach the controls.
- If you have a fire blanket, put it over the pan.
- If you have put the fire out, leave the pan to cool completely.

### Deep-fat frying presents more dangers in your kitchen.

- Never fill a chip pan (or other deep-fat fryer) more than one-third full of oil
- Do not use a fire extinguisher on a pan of oil - the force of the extinguisher can spread the fire and create a fireball.
- **If you have an electrical fire in the kitchen:**
- Pull the plug out, or switch off the power at the fuse box - this may be enough to stop the fire immediately
- Smother the fire with a fire blanket, or use a dry powder or carbon dioxide extinguisher
- Remember: never use water on an electrical or cooking oil fire.

# USING THE HOB - GAS

- Use pans which are large enough to avoid overflows onto the hob surface.
- Wipe any spillage as soon as possible.
- Clean the hob top as regularly as possible, this will prevent any build up of grease which may be a fire hazard.
- Pans should not be allowed to come into contact with coloured trims during use as this may cause discolouration of the surface

## Use

- Place your pan onto the pan supports above the burner you wish to use.
- Push in and turn the selected control knob to the full on symbol (large flame).
- If your hob has an ignition button or switch on the fascia, press it in until your burner lights. If your hob has automatic ignition it will spark automatically when you push in the control knob.
- Hold the control knob in for 15 seconds then release. If the burner

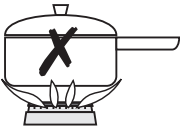

fails to light within this time, release the control knob and wait one minute before attempting to re-ignite.

- To simmer, turn the control knob to the small flame symbol. This will ensure that the flame is just large enough to gently heat the contents of the pan.
- To turn off, turn the control knob clockwise to the 'off' position.
- Always make sure that your pans are placed centrally on the burners and do not allow the flame to extend over

the base of the pan.

- Avoid the use of pans that overhang the edges of the hotplate.

In the event of a power failure, or the ignition not working, then a lighted match or taper can be used to light the burner.

## Energy Saving

- Position pans centrally over the elements.
- Only heat the amount of liquid you need.
- Once liquids have been brought to the boil, reduce the heat setting to a simmer.
- Consider using a pressure cooker if possible.
- Vegetables cut into small pieces will cook more quickly.
- Use a pan which is a close match to your element size.
- Smaller elements are ideal for simmering and stewing in smaller pans, while the larger elements are ideal for frying and boiling.

## FOLD DOWN LID (IF FITTED)

**Caution:** Glass lids may shatter when heated. Turn off all the burners before shutting the lid.

When opening and closing the lid, use the cooler outer sides of the lid glass.

The lid must be opened fully, so there is no danger of it closing while the hob is being used.

The appliance is fitted with a safety system, which will automatically turn off the hot plate burners if they are inadvertently left on as the lid is closed.

The lid is not intended to be used as a work surface, as it becomes hot when any part of the cooker is in use, and the surface may be scratched if items with rough or sharp surfaces are placed on it.

# USING THE GRILL - ELECTRIC

---

**WARNING:-** The vents on the grill canopy are there to allow heat escape. Items MUST NOT be placed on top of the grill canopy.

Accessible parts may be hot when the grill is used. Young children should be kept away.

## General

Your double grill has full variable control and both the left hand and right hand grills are independent of each other. This allows you to use either the left hand or right hand grill individually or both together.

## Fitting the grill pans

Make sure that the grill pan is first pushed back to the rear stop position and engage onto the grill pan runners before pulling forward to the front stop position.

## Removing the grill pans

Push the grill pan along the grill pan runners back to the rear stop position. lift off and remove.

## Preheating

Always preheat the grill for about 3 to 5 minutes, for best cooked results.

## Grilling

The temperature of both grills is variable, and can be adjusted by turning the grill control to the required setting. Grilling can also be adjusted by use of the trivet - there are three different grilling positions, as the grill trivet, which is in the grill pan, may be inverted to give a high or low position or the trivet may be removed, as detailed below: -

1. The HIGH trivet position is suitable for toasting bread.
2. The LOW trivet position is suitable for grilling all types of meat & fish.
3. With the grill trivet removed the food is placed directly on the base of the grill pan, eg; when cooking whole fish or browning dishes such as cauliflower cheese.

Food for grilling should be positioned centrally on the trivet & the grill pan should be pushed fully in to its stop position.

Never allow fat to build up in the grill pan as this creates a fire hazard.

If cleaning the grill pan when it is hot, use oven gloves to move it.

**When you have finished grilling, check that both the control knobs are returned to the 'off' position.**

## Aluminium foil

Using aluminium foil to cover the grill pan and/or trivet, or putting items wrapped in foil under the grill can create a fire hazard; also, the high reflectivity of aluminium foil can damage the grill element.

# USING THE OVEN - SLOW COOK (if fitted)

---

**WARNING:-** Accessible parts may become hot during use. Young children should be kept away.

## Introduction

One of your oven compartments is an electric oven which provides a gentle heat suitable for slow cooking or keeping food warm.

The slow cook element is positioned in the base of the slow cook compartment- always make sure that the prepared cooking pot is placed centrally on the base of this compartment.

Do not use any compartments to store food or canned items.

## Cooking times

The cooking time varies according to the type of food being cooked, and experience will show how long foods should be cooked for, according to personal taste and preference.

In general foods should be cooked for at least 5 hours, and maybe left up to 8-10 hours without spoiling if covered. As a guide, foods cooked using the slow cook oven will take about three times longer than they would in a conventional oven.

## Utensils

Any oven proof utensils maybe used for slow cooking, provided they have a close fitted lid.

To rectify a badly fitting lid a piece of cooking foil may be placed over the dish, under the lid.

For convenience and to save washing up, the most useful utensils for slow cooking are the flame proof type which can be used over direct heat and for oven

cooking, and are sufficiently attractive to use as serving dishes.

## Keeping food warm

Turn the oven on, and allow to pre-heat for 20 minutes before placing the food in the oven. If food is to be kept moist then it is important to cover the dish or plate to prevent food from drying out. This can be done using aluminium foil if the dish does not have a lid.

Do not use cling film to cover food as it cannot withstand the heat produced in the oven.

Some foods are best left uncovered if you wish to keep the food dry and crisp.

Do not add gravy to plated meals until serving.

Carved meat should be placed on one plate and covered, adding just one tablespoon of gravy to keep it moist. When keeping plated meals warm it is recommended that the food is placed on hot rather than cold plates.

## Slow Cooking

Slow cooking has always been the best way to prepare a nutritious hot meal with the minimum of preparation and maximum time away from the kitchen. The benefits of slow cooking have been recognized by cooks for centuries, and are still appreciated by cooks today.



# USING THE OVEN - SLOW COOK (if fitted)

---

## The advantages of slow cooking are as follows:

- Food can be left to cook unattended for several hours and will keep hot for several hours if left covered, without spoiling for a further 2-3 hours, so foods can be left to cook while you are out for the day, or over night.
- Inexpensive cuts of meat become deliciously tender when slow cooked.
- Slow cooking will also produce moist, tender "roasts" with minimal meat shrink-age and reduced oven soiling.
- Dishes such as soups, vegetables, puddings savory dishes and preserves are also suitable for slow cooking.
- There is no topping up of steamers, steam filled kitchens or constant checking to do.

## Using the slow cook oven

Turn the oven on and preheat for 20 minutes. Always place the prepared cooking pot centrally on the base of the oven. Follow the guide lines for the best results.

- The maximum capacity of oven proof dishes should be no more than 2.5 litres (4.5 pints).
- Please note: The more you fill the dish/pot the longer it will take to cook.
- Cooking times will vary depending on the size and shape of the meat, or poultry.
- Always bring soups, casseroles and liquids before placing in a preheated oven. To give more colour to meat or poultry, fry the meat to brown and add to stock which is hot.
- All meat and poultry recipes need a minimum of 5 hours to cook.
- Make sure all frozen ingredients are

well thawed out.

- Always ensure that frozen poultry has thoroughly defrosted in a refrigerator and all ice crystals have melted.
- Cut root vegetables into smaller pieces as they take longer than meat to cook.
- If possible they should be sauteed for 2-3 minutes before slow cooking.
- Ensure that root vegetables are always at the bottom of the pan immersed in the cooking liquid.
- A meat thermometer should be used when cooking pork joints and poultry. The internal temperature of the food should reach 88 °C,
- Stuffed meat or stuffed poultry should not be slow cooked. Cook any stuffing separately.
- Cover casseroles with a lid, or foil to prevent loss of moisture.
- Adjust seasonings and thickenings at the end of cooking time.
- Dried red kidney beans must be boiled for a minimum of 10 minutes following soaking before inclusion in any dish.
- Opening the door during cooking, leads to heat loss, and will lead to increased cooking times.

# USING THE MAIN OVEN - ELECTRIC

---

**Accessible parts may be hot when the oven is used. Young children should be kept away.**

## **To switch on the oven**

Turn the oven control knob(s) to the required setting.

The red thermostat indicator (if fitted) will come on until the selected temperature is reached and then go off; it will turn on and off periodically as the thermostat operates to maintain the selected temperature.

To switch off, return the control knob to the "off" position.

## **When using the oven**

As part of the cooking process, hot air is expelled through a vent in the oven. When opening the oven door, care should be taken to avoid any possible contact with potentially hot air, since this may cause discomfort to people with sensitive skin. We recommend that you hold the underneath of the oven door handle.

## **PREHEATING**

### **Fanned oven**

When cooking sensitive items such as soufflé and Yorkshire puddings or, when cooking bread, we recommend that the oven is pre-heated until the neon switches off for the first time. For any other types of cooking, a pre-heat may not be required.

### **Conventional oven**

Preheating is always required

## **Manual Operation (fanned only)**

The programmer must be set to manual operation before the main oven can be used. If A (Auto) is on the programmer display, return the oven to manual by pressing the up and down buttons simultaneously. Any programme which has been set is cancelled.

## **The cooling fan**

The cooling fan may operate when the main oven is on and may continue to operate for a period after the oven has been switched off.

## **OVEN FURNITURE**

### **Oven shelves**

The oven shelf must be positioned with the upstand at the rear of the oven and facing upwards.

Position baking trays and roasting tins on the middle of the shelves, and leave one clear shelf position between shelves, to allow for circulation of heat.

### **Baking tray and roasting tins**

For best cooked results and even browning, the recommended size baking trays and roasting tins that should be used are as follows;

Baking tray 350mm x 250mm

This size of baking tray will hold up to 12 small cakes.

Roasting tin 370mm x 320mm

We recommend that you use good quality cookware. Poor quality trays and tins may warp when heated, leading to uneven baking results.

# USING THE MAIN OVEN - ELECTRIC

---

## Slow cooking (S Setting or 100°C)

- Make sure that frozen foods are thoroughly thawed before cooking.
- Do not slow cook joints of meat or poultry weighing more than 2¼kg/4½lb.
- Preheat the oven to 170°C and cook for 30 minutes, then adjust the oven control to (S) or 100°C (slow cook setting) for the remainder of the cooking time.
- Slow cooking times will be about 3 times as long as conventional cooking times.
- Do not open the oven door unnecessarily during slow cooking, as this will result in heat loss at low temperatures.
- Always use dishes with tightly fitting lids. To rectify badly fitting lids, place foil over the dish underneath the lid.

## Aluminium foil

Use foil only to cover food or cooking dishes, using foil to cover the shelves or oven base creates a fire hazard.

## Cooking with a fanned oven

**As this is a high efficiency oven, you may notice the emission of steam from the oven when the door is opened. Please take care when opening the door.**

If you are used to cooking with a conventional oven you will find a number of differences to cooking with a fan oven which will require a different approach:

There are no zones of heat in a fan oven as the convection fan at the back of the oven ensures an even temperature throughout the oven.

This makes it ideal for batch baking - eg; when planning a party as all the items will be cooked within the same length of time.

Foods are cooked at a lower temperature than a conventional oven, so conventional recipe temperature may have to be reduced. Please refer to the conversion chart.

Preheating is generally not necessary as a fan oven warms up quickly.

There is no flavour transference in a fan oven, which means you can cook strong smelling foods such as fish at the same time as mild foods - eg; milk puddings.

When batch baking foods that will rise during cooking - eg; bread - always ensure that enough space has been left between the shelves to allow for the rise.

## Notes:

When 2 or more shelves are being used, it may be necessary to increase the cooking time slightly.

Because the 2 oven shelves are wider than in many ovens, it is possible to cook 2 items per shelf - eg; 2 victoria sandwiches or 2 casseroles.

Although you need to keep in mind the points 'To help the air circulate freely' with careful choice of dishes and tins, it is possible to cook a complete meal, and perhaps something else for the freezer, in the oven at the same time.

When roasting meats, you will notice that fat splashing is reduced, which is due in part to the lower oven temperatures, and will help keep cleaning of the oven to a minimum.

Because a fan oven has an even temperature throughout the oven, there is no need to follow the shelf positions given in the baking guide.

# USING THE MAIN OVEN - ELECTRIC

---

There is no need to interchange dishes onto different shelves part way through cooking, as with a conventional oven.

## To help the air circulate freely

Position the shelves evenly within the oven and maintain a clearance from the oven roof and base.

If more than one cooking dish or baking tray is to be used on a shelf, leave a gap of at least 25mm between the items themselves and the oven interior.

## Defrosting and cooling in the main oven

To defrost frozen foods, turn the main oven control to the defrost position, place the food in the centre of the oven and close the door.

To cool foods after cooking prior to refrigerating or freezing, turn the main oven control to the defrost position and open the door.

## Defrosting times

Small or thin pieces of frozen fish or meat - eg; fish filets, prawns & mince will take approximately 1 - 2 hours.

Placing the food in a single layer will reduce the thawing time.

A medium sized casserole or stew will take approximately 3 - 4 hours.

A 1½kg/3lb oven ready chicken will take approximately 5 hours, remove the giblets as soon as possible.

## Be safe

Do not defrost stuffed poultry using this method.

Do not defrost larger joints of meat and poultry over 2kg/4lb using this method.

Never place uncooked food for defrosting next to cooked food which is to be cooled, as this can lead to cross contamination.

Defrosting meat, poultry, and fish can be accelerated using this method but make sure they are completely thawed before cooking thoroughly. Place meat and poultry on a trivet in a meat tin.

## MAIN OVEN BAKING GUIDE

### Cooking times & temperatures

The temperature settings and times given in the baking guide are based on dishes made with block margarine. If soft tub margarine is used it may be necessary to reduce the temperature setting.

Allow enough space between shelves for food that will rise during cooking.

Do not place items on the oven base as this will prevent air circulating freely.



# USING THE MAIN OVEN - ELECTRIC

Note: this is a high efficiency oven, therefore some adjustment will have to be made to conventional cooking temperatures. The table below shows conventional cooking temperatures, 'A' efficiency temperatures and gas marks. For optimum results,

conventional temperatures need to be converted to 'A' efficiency temperatures.

For example, an item which would normally cook at a conventional temperature of 180 °C, will now cook at the 'A' efficiency temperature of 160°C.

Conventional temperature (°C)	'A' Efficiency Oven (°C)	Gas Mark
100	100	1/4
110	110	1/4
130	120	1/2
140	130	1
150	140	2
160	150	3
180-190	160	4-5
200	170	6
220	180	7
230	190	8
250	200	9

Food Type	Temperature settings °C		Time Approx.	Shelf Position
	Conv 	Fanned 		
<b>Cakes</b>				
<b>Small cakes</b>	190	160	15 - 25	2 - 4
<b>Victoria sandwich</b>	180	160	20 - 30	3
<b>Semi rich fruit cake</b>	150	125	2.5HRS - 3HRS	2
<b>Christmas cake</b>	150	125	2.5HRS - 3HRS	2
Puddings				
Bread and butter pudding	170	150	45 - 1hr	3
Fruit crumble	200	175	40 - 1hr	3
Miscellaneous				
Yorkshire pudding: large	220	200	40 - 48	4 - 5
small	220	200	15 - 20	4 - 5
Shortcrust pastry	200	180	Depends on filling	4 - 5

# USING THE MAIN OVEN - ELECTRIC

---

## Traditional fruit cakes

It should be remembered that ovens can vary over time, therefore cooking times can vary, making it difficult to be precise when baking fruit cakes.

It is necessary therefore, to test the cake before removal from the oven. Use a fine warmed skewer inserted into the centre of the cake. If the skewer comes out clean, then the cake is cooked.

- Follow the temperatures suggested in the recipe and then adjust accordingly to the conversion table.
- Do not attempt to make Christmas cakes larger than the oven can cope with, you should allow at least 25mm (1 inch) space between the oven walls and the tin.
- Always follow the temperatures recommended in the recipe.
- To protect a very rich fruit cake during cooking, tie 2 layers of brown paper around the tin.
- We recommend that the cake tin is not stood on layers of brown paper, as this can hinder effective circulation of air.
- Do not use soft tub margarine for rich fruit cakes, unless specified in the recipe.
- Always use the correct size and shape of tin for the recipe quantities.

## Roast turkey

Roasting turkey involves cooking two different types of meat - the delicate light breast meat, which must not be allowed to dry out, and the darker leg meat, which takes longer to cook.

The turkey must be roasted long enough for the legs to cook, so frequent basting is necessary. The breast meat can be covered once browned.

- Always make sure that the turkey is completely thawed and that the giblets are removed before cooking.
- Turkey should be roasted at 160°C - 180°C (fanned) or 180°C - 200°C (conventional) for 20 minutes per lb, plus 20 minutes, unless packaging advises otherwise.
- The turkey can be open roasted, breast side down, for half of the cook time, and then turned over for the remainder of the cooking time.
- If the turkey is stuffed, add 5 minutes per lb to the cooking time.
- If roasting turkey covered with foil, add 5 minutes per 1lb to the cooking time.

To test if the turkey is cooked, push a fine skewer into the thickest part of the thigh. If the juices run clear, the turkey is cooked. If the juices are still pink, the turkey will need longer cooking.

# USING THE MAIN OVEN - ELECTRIC

## Roasting guide

The times given in the roasting guide are only approximate, because the size and age of the bird will influence cooking times as will the shape of a joint and the proportion of the bone.

Frozen meat should be thoroughly thawed before cooking. For large joints it is advisable to thaw over night.

Frozen poultry should be thoroughly thawed before cooking. The time required depends on the size of the bird - eg; a large turkey may take up to 48 hours to thaw.

Use of a trivet with a roasting tin will reduce fat splashing and will help to keep the oven interior clean. Alternatively, to help reduce fat splashing, potatoes or other vegetables can be roasted around the meat/poultry.

## Notes:

- When cooking stuffed meat or poultry calculate the cooking time from the total weight of the meat plus the stuffing.
- For joints cooked in foil or covered roasters, and for lidded casseroles, add 5 minutes per 450g (1lb) to the calculated cooking time.
- Smaller joints weighing less than 1.25kg (2½lb) may require 5 minutes per 450g (1lb) extra cooking time.
- Position the oven shelf so that the meat or poultry is in the centre of the oven.
- It is recommended that the appliance is cleaned after open roasting.

<b>Cook in main oven at:</b> <b>160°C - 180°C (fanned)</b> <b>180°C - 200°C (conventional)</b>		<b>Approximate Cooking Time</b> <b>(preheated oven)</b>
<b>Beef</b>	Rare Medium Well done	20 minutes per 450g (1lb), plus 20 minutes 25 minutes per 450g (1lb), plus 25 minutes 30 minutes per 450g (1lb), plus 30 minutes
<b>Lamb</b>	Medium Well Done	25 minutes per 450g (1lb), plus 25 minutes 30 minutes per 450g (1lb), plus 30 minutes
<b>Pork</b>		35 minutes per 450g (1lb), plus 35 minutes
<b>Poultry</b>		20 minutes per 450g (1lb), plus 20 minutes

# USING THE CLOCK/PROGRAMMER-ELEC(IF FITTED)

## THE ALTERNATIVE PROGRAMMERS

There are two types of programmer covered in this section - push button & touch control. Both programmers have the same symbol variants & functions but may vary in their method of operation.

### The push button programmer

Symbol	Symbol	What is it?
∨	-	<p><b>Down/minus</b></p> <p>Used to decrease cook / end time, remove minutes from the minute minder and adjust the time of day. Also for listening to and setting the alarm tone.</p>
^	+	<p><b>Up/plus</b></p> <p>Used to increase cook / end time, add minutes to the minute minder and adjust the time of day.</p>
<p><b>FUNCTION</b> or</p> 	<b>MODE</b>	<p><b>Function button</b></p> <p>Used to select the functions available on this timer.</p> <p>Press once for: Minute Minder. Press twice for: Cook time Press three times for: End time.</p> <p>How to use these functions is explained later on in this section.</p>

The 'function' button in the centre is used for setting the minute minder and setting up the automatic cooking. See below for details.

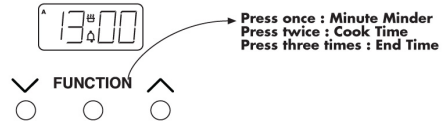

### Symbols on the LED display.

This 'A' symbol appears when either a semi, or fully automatic program is selected. This symbol will flash while a program is being set.

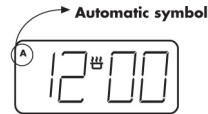

Once a program is set the symbol will light up, and remain lit until the alarm sounds, or the program is cancelled.

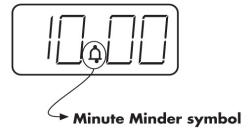

This bell symbol appears when the Minute Minder function has been selected.

While the Minute Minder is being set, the Bell symbol flashes. Once the length of time is set, the Bell symbol remains lit until the time runs down, or the function is cancelled.



This message and 'A' symbol appear when you are asked to set the length of time you require the oven to cook automatically for. Using the Up and Down buttons adjusts this accordingly.



This message and 'A' symbol appear when



# USING THE CLOCK/PROGRAMMER-ELEC(IF FITTED)

you are asked to enter in an end time, or when you would like the oven to switch itself off.

## To set the time of day

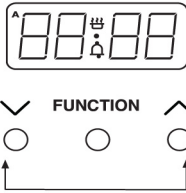

- Press the Up and Down buttons together for a few seconds, and release.
- The '•' in between the numbers on the LED Display will begin to flash.
- While the '•' is flashing it is possible to adjust the time using the Up and Down buttons. Once the time has been set, allow approximately 30 seconds before using any of the other timer functions. This ensures that the time will remain correct.

## To select an alarm tone

There are three tones to choose from.

- Press and hold the down button to listen to the first tone.
- Release the down button and press it again to listen to the second tone etc.
- Releasing the down button after the tone has sounded will automatically select that tone.

## Setting the minute minder

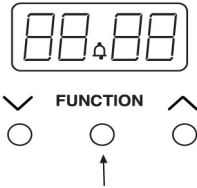

- To set the Minute Minder, press the Function button once. The bell symbol will appear and start flashing. The flashing only lasts for 5 seconds so the time must be set within this time frame.
- Use the Up and Down button to set the length of time required. Once this has been done, the Minute Minder is set.
- When the desired length of time has counted down the alarm will sound.
- To cancel the tone, press any of the buttons.
- To cancel the Minute Minder at any time, press the Up and Down buttons together.

# USING THE CLOCK/PROGRAMMER-ELEC(IF FITTED)

---

## **Semi-automatic cooking**

There are two types of semi automatic cooking available on this appliance.

The oven must be switched on, and in use to use either of these functions successfully.

The Duration method allows you to set the oven for a specific length of time. If a dish needed 2 hours to cook, then it would be possible for you to set the oven to turn off 2 hours later. This allows you to be sure that your food will be cooked for a set length of time and no longer.

The End Time method allows you to enter a specific time when you would like the oven to switch off. If you wish to leave the oven unattended, then it offers peace of mind that the oven will have turned itself off at the set time.

However, once the program is set then it cannot be adjusted. Extra time cannot be added, nor can the end time be extended.

To cancel the semi automatic programs, press both the Up and Down buttons together. This can be done at any time during the cooking process. Then if necessary, re program.

For the instructions on how to use both of these functions, please see the following page.

## **Fully automatic cooking**

This function incorporates both a duration and an end time and is meant to be used when you wish to delay the start time.

We recommend that the first few times this function is used you are in the house, this will familiarise you with your oven and prevents food from being over cooked or under cooked.

Care must be taken when selecting foods for this function, it is not recommended for certain food items which may spoil, or are sensitive to being left.

It is also advisable to set the end time to be as close to your return as possible to prevent food being left standing.

# USING THE CLOCK/PROGRAMMER-ELEC(IF FITTED)

## SEMI-AUTOMATIC COOKING

### The duration method

- Press the Function button twice,(1) which will skip past the Minute Minder.
- The LED display will flash the word 'dur', (2) and the 'A' will flash on the left hand side of the display.
- Use the Up and Down buttons to set the length of time you want to cook for.(3) This must be done within 5 seconds or the time of day will show again.

Once this is done the oven will automatically switch off once the time has elapsed, and the alarm will sound.

To switch off the alarm, press any button.  
To view any remaining time press the function button twice.

### The end time method

- Press the Function button three times, which will skip past the Minute Minder and the Duration programmer. (4)
- The LED display will flash the word 'End' and the 'A' will flash on the left hand side of the display. (5)
- Use the Up and Down buttons to select the time the oven is required to turn off. (6)

Once this is done the oven will turn itself off at the time you have selected.

To switch off the alarm, press any button.

### 1. The Duration method

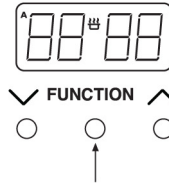

### 2.



### 3.

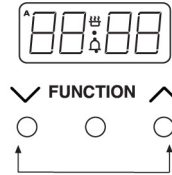

### 4. The End Time method

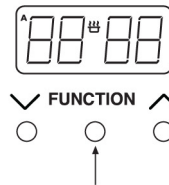

### 5.



### 6.

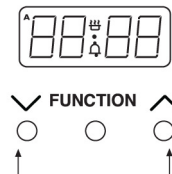

# USING THE CLOCK/PROGRAMMER-ELEC(IF FITTED)

## FULLY AUTOMATIC COOKING (EXAMPLE)

This programming method is best suited for when a delayed start time is required. Unlike the semi automatic methods this requires both the duration and the end time to be entered. The timer will work out the start time and begin cooking.

- Press the function button twice to select the length of time your food will need. (7)
- The 'A' on the left hand side will flash and the 'dur' message will flash up. (8)
- Using the Up and Down buttons set the time you require within 5 seconds of the 'dur' message. (9)
- Press the function button three times until the 'A' flashes again and the 'End' messages appears. (10) & (11)
- Using the Up and Down buttons, set the time you would like the oven to switch off. (12)
- Set the temperature of the oven and place the food inside.

While the automatic function is running, the 'A' will appear statically on the display, with the time.

Try to keep the end time as close to when you expect to return, this will prevent cooked food from being left standing in a warm oven.

The timer will calculate the appropriate start time.

To switch off the alarm, press any button.

7

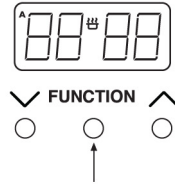

8



9

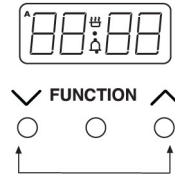

10

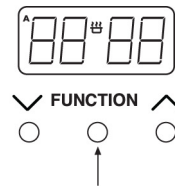

11



12

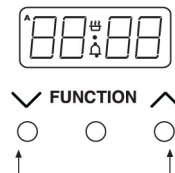

# USING THE CLOCK/PROGRAMMER-ELEC(IF FITTED)

## The touch control programmer

There are three touch control icons for this timer - the table below shows you what the symbols look like, depending on the model type, & their functions.

Note - some functions require you to 'touch & hold' an icon for a few seconds, whilst others require you to just 'touch' the icon without holding.

The 'function' icon in the centre is used for setting the minute minder & setting up the automatic cooking - see below for details.

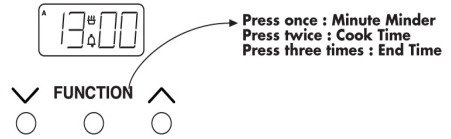

Sym- bol	Sym- bol	What is it?
∨	-	<b>Down/minus</b> Used to decrease cook / end time, remove minutes from the minute minder and adjust the time of day. Also for listening to and setting the alarm tone.
∧	+	<b>Up/plus</b> Used to increase cook / end time, add minutes to the minute minder and adjust the time of day.
<b>FUNC- TION</b>	<b>MODE</b>	<b>Function icon</b> Used to select the functions available on this timer.  Touch once for: Minute Minder.  Touch twice for: Cook time  Touch three times for: End time.  How to use these functions is ex- plained later on in this section.

## Symbols on the LED display.

This 'A' symbol appears when either a semi, or fully automatic program is selected. This symbol will flash while a program is being set.

Once a program is set the symbol will light up, and remain lit until the alarm sounds, or the program is cancelled.

This Bell symbol appears when the Minute Minder function has been selected.

While the Minute Minder is being set, the Bell symbol flashes. Once the length of time is set, the Bell symbol remains lit until the time runs down, or the function is cancelled.

This message and 'A' symbol appear when you are asked to set the length of time you require the oven to cook automatically for. Using the Up and Down icons adjusts this accordingly.

This message and 'A' symbol appear when you are asked to enter in an end time, or when you would like the oven to switch itself off.

# USING THE CLOCK/PROGRAMMER-ELEC(IF FITTED)

---

## Setting the time of day

Touch & hold the centre (function) icon for a few seconds until the ● symbol between the numbers on the LED display flashes.

While the ● symbol is flashing, you can adjust the time of day by touching the plus & minus icons. Please note: the hours & minutes adjust quickly.

Important - once the time of day has been set, allow approximately 30 seconds before using any of the other programmer functions. This ensures that the time of day will remain correct.

## Setting an alarm tone

Touch & hold the plus & minus icons simultaneously until the ● symbol flashes & you hear a beep - then touch the centre (function) icon.

Touch the minus icon to select the tone.

You can change the tone by repeatedly touching the minus icon - there are three tones to choose from.

## Setting the minute minder

To set the minute minder, touch & hold the centre (function) icon until the bell symbol appears & begins to flash. Important - the flashing will last for approximately five seconds, so any setting must be carried out within this time frame.

Touch the plus & minus icons to set the length of time required. Once this has been done, the minute minder is set.

When the desired length of time has counted down, the alarm will sound. To cancel the tone, touch & hold any of the icons.

To cancel the minute minder at any time, touch & hold the plus & minus icons together.

## Semi-automatic cooking

### Method 1 - duration (switch off after set time period):

Touch & hold the centre (function) icon; the bell will flash & you will hear a beep. Touch the centre (function) icon again - this will skip past the minute minder function.

The display will flash the word 'dur' & the 'A' will flash on the left hand of the display.

Use the plus & minus icons to set the length of time you want to cook for. The flashing will last for approximately five seconds, so the setting must be done within this time frame or the time of day will show again.

Once the duration has been set, the oven will automatically switch off. When the set time has elapsed the alarm will sound. To switch the alarm off, touch any icon.

To view any remaining time, touch & hold the centre (function) icon & touch again.

To cancel the semi-automatic programme at any time, touch the plus & minus icons together.

### Method 2 - end time (switch off at a set end time):

Touch & hold the centre (function) icon; the bell will flash & you will hear a beep. Touch the centre (function) icon again - twice - this will skip past the minute minder & duration functions.

The display will flash the word 'End' & the 'A' will flash on the left hand of the display.

# USING THE CLOCK/PROGRAMMER-ELEC(IF FITTED)

---

Use the plus & minus icons to select the time the oven is required to switch off.

Once this is done the oven will switch itself off at the pre-selected time. To turn the alarm off, touch any icon.

To cancel the semi-automatic programme at any time, touch the plus & minus icons together.

## **Fully automatic cooking**

This function allows the cooker to switch on & off automatically. It requires both the duration & the end time to be entered. The timer will work out the start time & begin cooking.

Touch & hold the centre (function) icon; the bell will flash & you will hear a beep. Touch the centre (function) icon again - this will skip past the minute minder function.

The display will flash the word 'dur' & the 'A' will flash on the left hand of the display.

Use the plus & minus icons to set the length of time you want to cook for. The flashing will last for approximately five seconds, so the setting must be done within this time frame or the time of day will show again.

Touch the centre (function) icon again - this skips past the minute minder & duration functions.

The display will flash the word 'End' & the 'A' will flash on the left hand of the display.

Use the plus & minus icons to select the time the oven is required to switch off.

Set the temperature of the oven & place the food inside. The timer will calculate the start time.

When this is done the oven will turn itself off at the time you have selected. To switch off the alarm, touch any icon.

To cancel the automatic programme at any time, touch the plus & minus icons together.

# USING THE MINUTE MINDER (IF FITTED)

## ELECTRONIC MINUTE MINDER

### Initial display

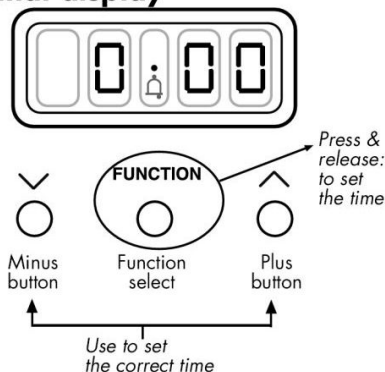

The digital timer enables you to set the time of day (24 hour clock) and the minute minder alarm.

### Setting the "Time of Day"

- Switch on the electricity supply to the appliance.
- The display will flash.
- Press and release the time of day button.
- Set the time of day with the plus and minus buttons.
- The time will be set 7 seconds after the last plus or minus operation.

### Alarm tones

After setting the time of day, you can select one of three alarm tones.

Press the minus button to listen to the first tone, then release the minus button and press it again to listen to the second tone, etc.

Releasing the minus button after a tone has sounded will automatically select that tone.

### Setting the minute minder

- Press and release the plus button to change the display from clock to minute minder - the bell symbol will light.
- Use the plus and minus buttons to set the length of time before the alarm tone will sound. The display will increase/decrease in units of 10 seconds up to 99 minutes 50 seconds, and in units of 1 minute from 1 hour 40 minutes upwards. The maximum period which may be set is 10 hours.

The display format will change after 99 minutes and 50 seconds to 1 hour and 40 minutes.

During countdown, the minute minder has priority on the display, which will show (in minutes : seconds, or hours : minutes) the time remaining.

When countdown is complete, the tone will sound for 7 minutes, or it can be reset with one touch of any button.

To cancel the minute minder at any other time, run down the set time with the minus button.

The display will revert to show the time of day.

## MECHANICAL MINUTE MINDER

Turn the minute minder control knob fully to the maximum setting, then turn back to the desired setting.

When countdown is complete, the timer will give a audible signal for a few seconds before it stops.



# CLEANING

---

## General

- It is important to clean the product regularly as a build up of fat can affect its performance or damage it and may invalidate your guarantee.
- Always switch off your appliance and allow it to cool down before you clean any part of it.
- Do not use undiluted bleaches, products containing chlorides, wire wool or abrasive cleaners on aluminium, stainless steel, or plastic/painted parts as they can damage the appliance. Nylon pads can also be unsuitable.
- Take extra care when cleaning over symbols on fascia panels. Excessive cleaning can lead to the symbols fading.

## Painted & Plastic parts

- Only use a clean cloth wrung out in hot soapy water.
- Do not use abrasive cleaners, such as "Cif", wire or nylon cleaning pads on these parts.

## Stainless steel & Aluminium surfaces

- Only use a clean cloth wrung out in hot soapy water, and dry with a soft cloth.
- Stubborn marks can be removed using a stainless steel cleaner. Supplies can be purchased from the Customer Care Centre.
- Sharp objects can mark the surface of stainless steel, but will become less noticeable with time.
- Wipe any spillage immediately, taking care to avoid burning your hands.

- Some foods are corrosive eg; vinegar, fruit juices and especially salt - they can mark or damage the metal if they are left on the surface.
- Baby oil can be used to restore stainless steel finishes - but only use a few drops. Don't use cooking oils as they can contain salts, which will damage the metal.
- Do not use steam cleaners.

## Enamel surfaces & parts

- Clean with warm, soapy water and a clean cloth.
- If larger splashes of fat do not readily disappear, you can use a mild cream cleaner to remove them. More stubborn marks can be removed using a soap filled pad.
- Rinse well and dry with a soft clean towel or cloth.
- Do not use steam cleaners.

## Glass parts

**WARNING:-** Do not use harsh abrasive cleaners or sharp metal scrapers to clean the oven door glass since they can scratch the surface, which may result in shattering of the glass.

- Only use a clean cloth wrung out in hot soapy water, or a specialist glass cleaner.
- Rinse away any excess cleaner and dry with a soft cloth.

## Chrome plated parts

- Use a moist soap filled pad, or place in a dishwasher

# CLEANING

---

## REMOVING OVEN PARTS FOR CLEANING

### Inner Door Glass

- The inner door glass panel can be removed for cleaning but it must be replaced the right way up. If there is any writing on the glass, you must be able to read it clearly when the cavity doors are open.
- Always make sure that the glass is pushed fully into the Stop position.
- To remove the glass panel, open the door wide, hold the top and bottom edges and slide out.
- Warning: do not operate the appliance without the glass panel correctly fitted.
- For your safety, glass door panels are made of toughened glass. This ensures that, in the unlikely event that a panel breaks, it does so into small fragments to minimise the risk of injury. Please take care when handling, using or cleaning all glass panels, as any damage to the surfaces or edges may result in the glass breaking without warning or apparent cause at a later date. Should any glass panel be damaged, we strongly recommend that it is replaced immediately.

### Shelf Runners

- Shelf runners can be removed to enable you to clean them thoroughly. Make sure they are cool to touch and then grasp the runners and slide out of their hanging holes.

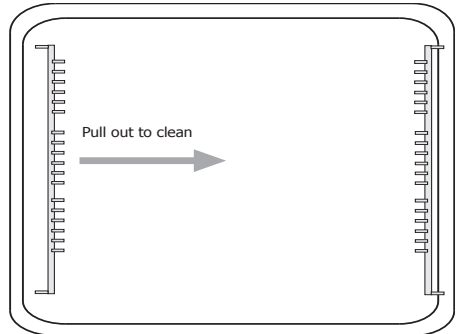

# CLEANING

## GAS HOB

### Burner caps and heads

- The slots in the burner head where the flames burn should be cleared of deposits.
- Clean with a nylon brush, rinse and then dry thoroughly. There may be brown coloured markings on your burners; these are carbon deposits or fat stains and can be removed using a soap filled pad.
- Do not put burners in the dishwasher or soak them. Using dishwasher powders, washing up liquids and caustic pastes can damage the burners.
- Burner caps and heads must be repositioned correctly so that they sit squarely on to the hob as shown. This is particularly important with stainless steel models as failure to re-position the caps correctly may result in discolouration of the stainless steel around the burners.

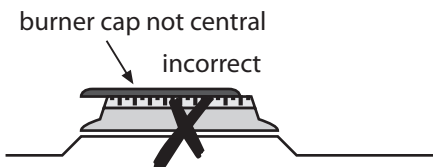
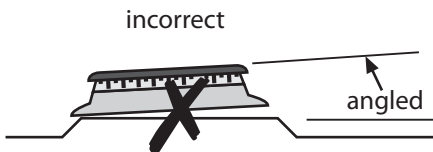
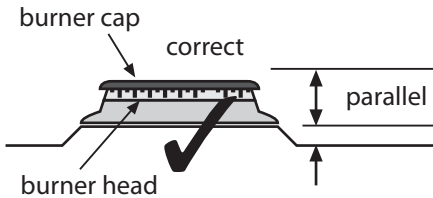

### Cast iron griddle or pan supports (if fitted)

- Ensure the griddle has fully cooled and scrape off any stubborn marks and bits of food with a plastic or wooden cooking implement. Rinse in warm soapy water and dry with a tea towel.
- Do not clean in a dishwasher.
- If you notice any rusting on your griddle, or pan-supports, simply clean in warm soapy water, then re-season.
- To season: Heat the griddle for 30 seconds at a medium setting then switch off. Use a minimum amount of unsalted vegetable oil, on a dry cloth or paper towel, and apply a thin coat of oil to the element surface. Wipe off the excess and re-heat the griddle for one minute.

# INSTALLATION INSTRUCTIONS - DUAL FUEL

---

## **Before you start: Please read the instructions. Planning your installation will save you time and effort.**

Prior to installation, ensure that the local distribution conditions (nature of the gas and gas pressure) and the adjustment of the appliance are compatible. The adjustment conditions are stated on the data badge.

This appliance is not connected to a combustion evacuation device. It shall be installed and connected in accordance with current installation regulation. Particular attention shall be given to the relevant requirements regarding ventilation.

In your own interest and that of safety, it is the law that all gas appliances be installed and serviced by competent persons. GAS SAFE registered installers undertake to work to satisfactory standards.

Where regulations or standards have been revised since this handbook was printed, always use the latest edition.

## **In the UK the regulations and standards are as follows:**

1. Gas Safety Regulations 1996 (Installation and Use).
2. Building Regulations - Issued by the Department of the Environment.
3. Building Standards (Scotland) (Consolidated) - Issued by the Scottish Development Department.
4. The current I.E.E. Wiring Regulations.
5. Electricity at Work Regulations 1989.
6. BS 6172 Installation of Domestic Gas cooking Appliances.
7. Installation & Servicing Instructions for this appliance.

For installation in countries other than the UK, the appliance must be connected in accordance with all local gas and electrical regulations. In the Republic of Ireland, Installers should refer to IS813 Domestic Gas Appliances.

## **Ventilation requirements**

The use of a gas cooking appliance results in the production of heat and moisture in the room in which it is installed. Ensure that the kitchen is well ventilated: keep natural ventilation holes open or install a mechanical ventilation device (mechanical extractor hood). Prolonged intensive use of the appliance may call for additional ventilation, for example, opening of a window, or more effective ventilation, for example increasing the level of mechanical ventilation where present.

The room containing the appliance should have an air supply in accordance with BS 5440: Part 2: 1989:

All rooms require an openable window, or equivalent, and some rooms will require a permanent vent as well.

For room volumes up to  $5\text{m}^3$  an air vent of  $100\text{cm}^2$  is required.

If the room has a door that opens directly to the outside, or the room exceeds  $10\text{m}^3$ , NO AIR VENT is required.

For room volumes between  $5\text{m}^3$  and  $10\text{m}^3$  an air vent of  $50\text{cm}^2$  is required.

If there are other fuel burning appliances in the same room, BS 5440: Part 2: 1989 should be consulted to determine the air vent requirements.

This appliance must not be installed in a bed sitting room of less than  $20\text{m}^3$  or in a bathroom or shower room.

# INSTALLATION INSTRUCTIONS - DUAL FUEL

---

Windows and permanent vents should therefore not be blocked or removed without first consulting a GAS SAFE gas installer.

In the Republic of Ireland, refer to relevant Irish Standards for correct ventilation requirements.

Failure to install appliances correctly is dangerous and could lead to prosecution.

Whilst every care is taken to eliminate burrs and raw edges from this product, please take care when handling - we recommend the use of protective gloves during installation.

## **Levelling Your Cooker**

Place a spirit level on a baking sheet onto an oven shelf.

The cooker is fitted with LEVELLING FEET. Level your cooker to your desired height using the levelling feet at the front and rear of the cooker.

## **Moving the cooker**

Please note that the weight of this appliance is approximately 110kg (unpacked). Take care if the appliance needs to be lifted during installation. It is advised that multiple personnel are used when moving this appliance - always use an appropriate method of lifting.

Do not attempt to move the cooker by pulling on the doors or handles. Open the door and grasp the frame of the cooker, taking care that the doors do not shut on your fingers.

Take care to avoid damage to soft or uneven floor coverings when moving the appliance. Some cushioned vinyl floor coverings may not be designed to withstand sliding appliances without marking or damage.

**Important:** Ensure that you route all mains cables well clear of any adjacent heat source.

# INSTALLATION INSTRUCTIONS - DUAL FUEL

## Clearances

This cooker must have a 10mm gap between the side of the appliance and the base and wall units of your kitchen.

- No obstructions/extractor hoods are to be placed between the top of the canopy and the ceiling once the appliance has been installed.

- Please adhere to the manufacturers instructions.

The important dimensions are those around the appliance.

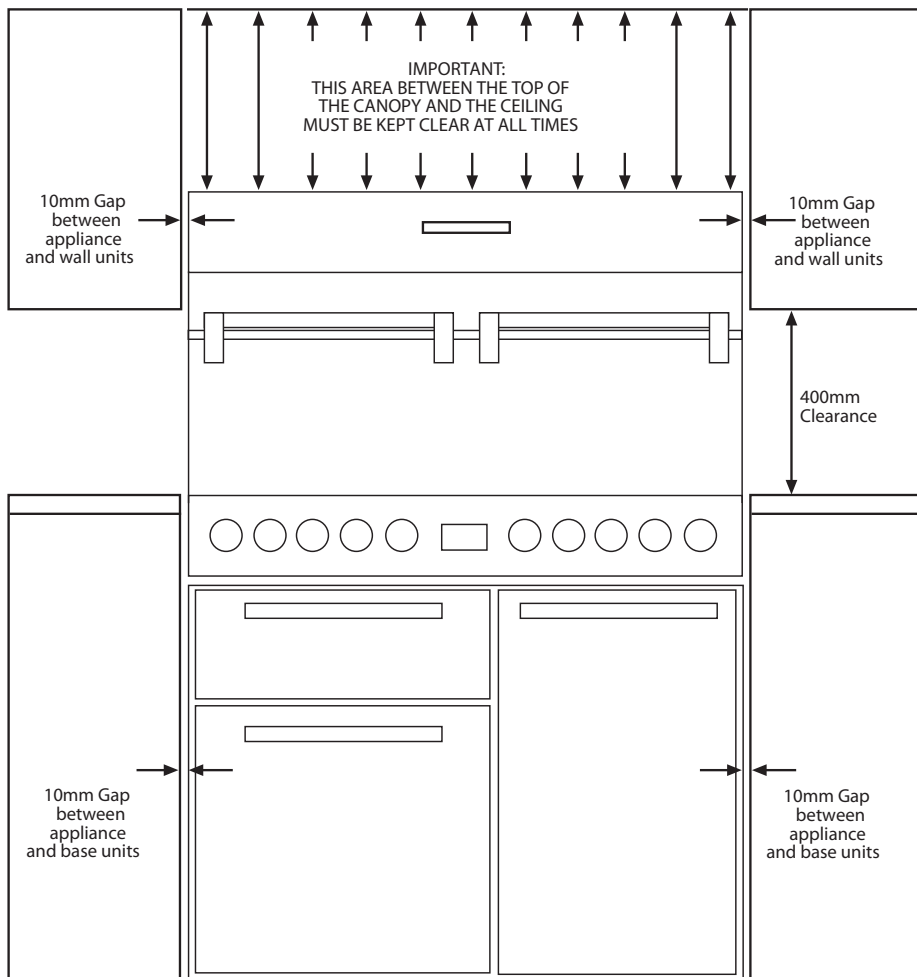

WIDTH OF APPLIANCE: 900mm  
HEIGHT OF APPLIANCE: 1520-1550mm

# INSTALLATION INSTRUCTIONS - DUAL FUEL

## Fitting the plinth (if applicable)

- Ensure the appliance is raised to a height of 915mm or above using adjusting feet (A) before beginning.
- Open the appliance doors and loosen screw (C), do not remove the screw entirely. If your appliance has a storage drawer at the bottom, you access these screws through holes located at the base of the drawer after lifting the mat.
- Fit plinth (B) and secure using screw (C).

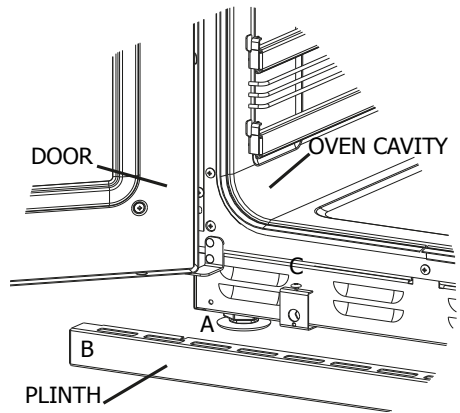

## Securing the canopy (if applicable)

- Fit screw(s) A through holes 1 and into holes 2 at both ends of the rear surface of the canopy.
- Ensure that the product is level and use the holes in the bracket as a template and mark the fixing hole positions.
- Drill and plug the wall to accommodate the product. (Note: Plugs not supplied)
- Fixing to the wall should be carried out in line with sound building practices. (Note: Plugs and screws not supplied)

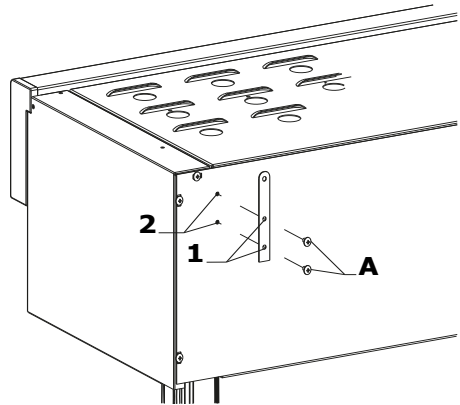

## Fitting the towel rail (if applicable)

- On the towel rail there are two holes, top (A) and bottom (B), these holes have corresponding holes on the fascia at each end.
- The screw for the top hole (A), must be screwed into the supplied adaptor, whereas the remaining screw just goes through the bottom hole (B). Both screws are M6 screws. Using the allen key provided, tighten the screws making sure that the towel rail is flush to the fascia, but not over tightened.

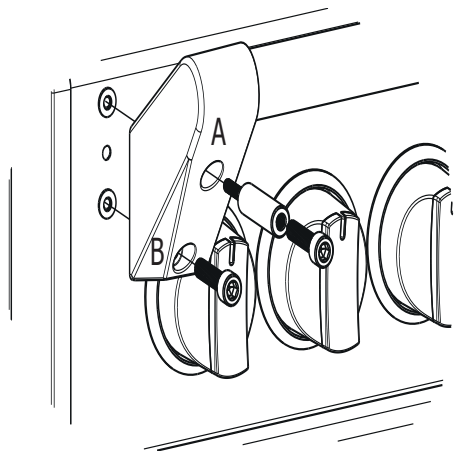

# INSTALLATION INSTRUCTIONS - DUAL FUEL

## CONNECT TO THE ELECTRICITY SUPPLY

Warning: This appliance must be earthed.

The appliance must be installed by a competent electrician using a double pole control unit of 32 ampere minimum capacity with 3mm minimum contact separation at all poles.

We recommend that the appliance is connected by a qualified electrician who is a member of the N.I.C.E.I.C. and who will comply with the I.E.E. and local regulation.

1. Access to the mains terminal is gained by opening the terminal block cover at the rear of the appliance (use a small flat-bladed screwdriver).
2. Connection should be made with a suitable flexible cable.
3. First strip the wires, then push the cable through the cable clamp in the terminal block cover.
4. Connect the cable to the terminal block and tighten the cable clamp screw (see diagram).
5. Close the terminal box, ensuring that the cover is engaged on the locking tabs.

**Important:** ensure that you route all mains, electrical cables and flexible tubing well clear of any adjacent heat source.

Note: Your appliance will be fitted with one of the two terminal blocks shown on the right, block A or block B

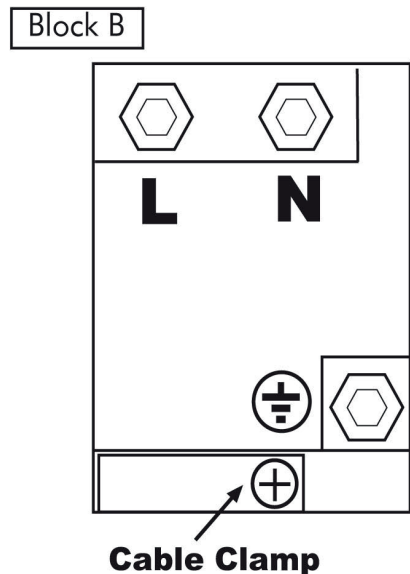
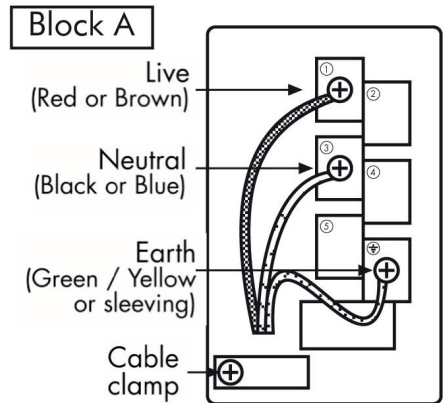



# INSTALLATION INSTRUCTIONS - DUAL FUEL

---

## CONNECT TO THE GAS SUPPLY

The inlet to the cooker is ½" BSP internal situated at the rear right corner. Fit the bayonet connection. This should be located so as to ensure that the flexible connector hose does not kink.

Under no circumstances should the flexible connector be allowed to come into contact with the vertical oven flue tubes on the rear of the appliance.

Use a 900mm - 1125mm length of flexible connector.

Ensure that all pipework is of the correct rating for both size and temperature.

Natural Gas - Flexible connections should comply with BS 669. Parts of the appliance likely to come into contact with a flexible connector have a temperature rise of less than 70°C.

After installation, make sure all connections are gas sound.

## COMMISSIONING

### Burner aeration

All burners have fixed aeration and no adjustment is possible.

### Pressure setting

G20 Natural Gas @ 20 mbar

### Pressure test point

Use the large burner injector located in the burner bowl.

## Hob burner

Turn the control knob to the FULL ON position, wait a second before pressing the ignition switch or holding a lighted match or taper to the burner. Hold the control knob in for 15 seconds. Do not hold the control knob in for longer than 15 seconds. If the burner fails to light within this time, release the control knob and wait one minute before attempting further ignition.

## Before leaving the installation

1. Place all the loose parts of the cooker into position.
2. Show the customer how to operate the cooker and give them this handbook. Thank you.

# TECHNICAL DATA

---

## Type of gas:

Natural Gas I<sub>2H</sub>

Natural Gas II<sub>2H3+\*</sub>

LP Gas I<sub>3+</sub>

Please see data badge your for specified gas type. \* Can be converted from Natural gas to LP Gas

Never attempt to convert an appliance - unless the data badge states that you can.

## Burner Aeration:

Fixed

## Pressure setting:

G20 Natural Gas @ 20mbar

G30 Butane @ 28-30mbar

G31 Propane @ 37mbar

Electrical supply:

220 - 240V ~ 50Hz

Injectors used (hotplate)

Size	Natural Gas	LP Gas
Small	77	50
Medium	104	70
Large	129	87
Wok	121 & 63	87 & 35

Countries of destination

GB

IE

# TECHNICAL DATA

Fuel Type	Hotplate Burner / Element	Nominal Rate Kw
Natural Gas	Hob - small Hob - medium x 2 Hob - large Hob - wok  Total heat input •5 burners	1.0kW 2.0kW 3.0kW 3.5kW  11.5kW
LP Gas	Hob - small Hob - medium x 2 Hob - large Hob - wok  Total heat input •5 burners	1.0kW 2.0kW 3.0kW 3.5kW  11.5kW

Fuel Type	LH Fanned Oven	RH Fanned Oven	Variable grills	Slow Cook Oven	Oven lamps
<b>Electric @ 240V</b>	2.0kW	2.5kW	1.8kW (LH) 1.8kW (RH)	0.17kW	25W each
<b>Appliance size</b>		<b>900</b>			
<b>Appliance maximum load (@240V)</b>		6.915kW			

# CUSTOMER CARE

---

## FAQs

### **What parts of the appliance can be washed in a dishwasher?**

- Any enamelled parts such as the grill-pan can be cleaned in a dishwasher, as can oven shelves and shelf guides.

### **What parts must NOT be cleaned in a dishwasher?**

- Parts such as burner skirts and caps, control knobs and any cast iron items must not be cleaned in a dishwasher, they should be cleaned with hot soapy water and a nylon brush once they are cool enough.

### **There's been a power failure and the product won't work.**

- Switch off the electricity supply.
- When the power returns switch the electricity supply back on and re-set any programmer/clock to the correct time of day.

### **My oven is a single combined oven and grill - can I use both functions together?**

- No. You can only use one or the other.

### **Why is there condensation on the doors?**

- Condensation is caused by hot, moist air meeting a cooler surface (i.e. the oven door). You cannot always prevent it, but you can minimise it when it happens by doing the following:
- Pre-heat the oven at a high temperature before putting food in the oven, and cover the food you are cooking wherever possible.
- Whenever you can, cook wet foods at higher temperatures.
- Don't leave food in the oven to cool down.
- Automatic cooking will normally produce condensation when the oven is

cooling down with food inside.

### **Should the cooling fan continue to run once the appliance has been switched off?**

- Yes. This is to make sure that you can always touch the control knobs to make temperature adjustments, and turn your appliance off.

### **What is a Multifunction oven?**

- A multifunction oven combines a variety of features, which are explained fully earlier in this book (if fitted), it allows you more flexibility when cooking.

### **The neon on my appliance keeps going out and coming back on again - is this right?**

- Yes. In most cases the neon (if fitted) will cycle on and off to show that oven is maintaining your temperature choice.

### **Can all gas appliances be converted from Natural Gas to LP Gas?**

- Not all gas appliances can be converted. If Category II is stated on the databadge, then the appliance may be converted and a conversion kit must be obtained if not already provided. If in doubt, please contact Customer Care for further advice - do not attempt to convert an appliance if it is not compatible.

### **Why won't the ignition work?**

- Check there is a spark when the ignition button is depressed. If there is no spark, check the electricity supply is switched on at the socket. Check that the gas supply is switched on.

### **Call Customer Care for a Service Engineer's visit if:**

- You find that the oven becomes hotter at a particular temperature - the thermostat may need replacing.
- The cooling fan fails to work.

# CUSTOMER CARE

---

## CHANGING LIGHT BULBS (where fitted)

Warning: There is a risk of electric shock, so always make sure you have turned off and unplugged your appliance before starting. Always allow the product to cool down before you change a bulb.

Not all appliances have the same number and type of bulbs. Before replacing your bulb, open the oven door and see which type you have. Then use the table to help you change your bulb correctly.

Bulbs can be purchased from hardware stores (always take the old bulb with you).

Please remember that bulbs are not covered by your warranty.

No of Lamps	Bulb location	Oven Type	Instructions
2	Side	All	Remove the oven shelves. Grasp the lens cover on the light fitting and pull it away from the side of the oven. Unscrew the bulb and replace. Replace the lens cover
1	Rear	Fanned/Multifunction (Electric)	Remove the oven shelves. Remove the loose oven back by unscrewing the 4 securing screws (one at each corner) and remove. Unscrew the lens cover by turning anticlockwise. Remove the bulb and replace. Replace the lens cover and oven back.
1	Rear	Conventional/Fanned (Gas)	Remove the oven shelves. Unscrew the lens cover by turning anticlockwise. Remove the bulb and replace. Replace the lens cover.

Please keep this handbook for future reference, or for anyone else who may use the appliance.

Please keep this handbook for future reference, or for anyone else who may use the appliance.

# CUSTOMER CARE

---

For spares and after-sales service please contact Burco on:

**T: 0844 815 3745**

**F: 0844 815 3748**

**E: info@gdha.com**

Please ensure that you have the product's model no and serial no available when you call. These can be found on the silver data label on your product which is located:

Ovens	Open the door; adjacent to the oven cavity
High-level grill products	Inside the base compartment
Hobs	On the underside of the product

Enter appliance numbers here for future reference:

Model No.:

--	--	--	--	--	--	--	--	--	--

Serial No.:

--	--	--	--	--	--	--	--	--	--

## SERVICE RECORD

Date of purchase	Installed by	Installation Date
Place of purchase:		

Date	Part(s) replaced	Engineers' name

For customers outside the UK and Northern Ireland, please contact your local supplier.

**Glen Dimplex Professional Appliances**  
**(A Division of Glen Dimplex Home Appliances)**  
**Stoney Lane, Prescot, Merseyside, L35 2XW**  
**www.gdpacatering.com**