

Warewashing

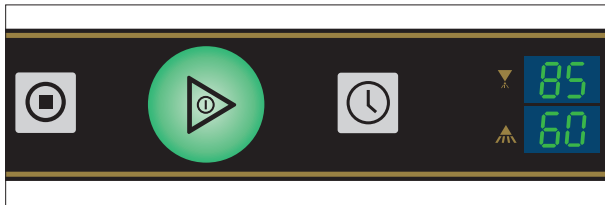

Hood-type dishwashers Ecomax Plus H 615



Installation and Operation Manual

(Original operation manual)

EN

Table of Contents

1	Notes on the documentation	4
1.1	Application.....	4
1.2	Layout of the documentation.....	4
1.3	Symbols used	4
2	Safety instructions and regulations	5
2.1	Hazard levels	5
2.2	Layout of safety instructions.....	5
2.3	Basic safety instructions	5
2.4	Property damage.....	7
3	Product description	7
3.1	Intended purpose.....	7
3.2	Designation	8
3.3	Technical data.....	8
4	Controls	8
5	Installation	9
5.1	Special safety instructions.....	9
5.2	Transporting to the installation location.....	9
5.3	Removing the packaging	9
5.4	Installing the machine	10
5.5	Connecting to the power supply.....	10
5.6	Connecting the water	11
5.7	Connecting the drain	11
5.8	Connecting the dispenser.....	12
6	Commissioning	13
6.1	Special safety instructions.....	13
6.2	Setting the water hardness (optional).....	13
6.3	Filling the salt reservoir (optional).....	13
6.4	Prepare chemical suction	14
7	Operation	15
7.1	Special safety instructions.....	15
7.2	Preparations for washing.....	15
7.3	Displaying and selecting the program	16
7.4	Washing.....	16
7.5	Switching off the machine.....	17
7.6	Executing daily cleaning	17
7.7	Executing weekly cleaning	17
7.8	Executing hygiene cleaning.....	17

8	Settings	18
8.1	Overview of operator menu	18
8.2	Open operator menu and make settings	18
8.3	Detergent/dosage amount	20
8.4	Rinse aid/dosage amount	20
8.5	Set water hardness	20
8.6	Wash cycles	21
8.7	Hose filling detergent	21
8.8	Hose filling rinse aid	22
8.9	External water treatment	22
8.10	Temperatures	24
8.11	Displaying the temperatures	25
9	Display of faults and information	25
9.1	Information	25
9.2	Error	25
10	Troubleshooting guide	26
10.1	Poor wash result	26
10.2	Other faults	27
11	Maintenance	27
12	Disposal	28
13	Product disclaimer	28
14	Conformity	29

Ecomax Plus H 615

Notes on the documentation

1 Notes on the documentation

1.1 Application

This document contains the most important information for the installation and commissioning of the machine by qualified personnel, as well as the information required for day-to-day operation by the operator.

- ▶ Keep the operation manual and all referenced documents in a safe and accessible place.
- ▶ Store the operation manual in a suitable container protected from humidity and dirt deposits.
- ▶ If you sell the machine, pass on the installation and operation manual.

1.2 Layout of the documentation

Referenced documents are all instructions that describe the installation, operation, maintenance and repair of the device, as well as additional instructions for all accessories used.









For the operator:

- Operating instructions

For the specialised tradesman:

- Installation instructions
- Circuit diagram
- Spare Parts Catalogue

1.3 Symbols used

Symbol	Meaning
	Beware of hazardous electrical voltage
	Beware of explosion
	Beware of crushing
	Beware of hazardous substances
	Beware of hand injuries
	Beware of slipping
	Beware of hazard area
	Useful additional information and tips





Symbol	Meaning
	Read operation manual

2 Safety instructions and regulations

2.1 Hazard levels

The hazard level is part of the safety instructions and is denoted by the signal word.

Potential consequences are differentiated by the choice of signal word.

	Imminent danger: results in serious physical injury or death.
	Potentially hazardous situation: may cause serious physical injury or death.
	Potentially hazardous situation: may cause minor physical injury.
	Potentially harmful situation: may cause damage to the product or other objects.

2.2 Layout of safety instructions

These warning notices are depicted with warning symbols and signal words in the corresponding safety colours.





Nature and source of the hazard

Explanation on the nature and source of the hazard

- ▶ Measures for averting the hazard
- ▶ Additional measures for averting the hazard, where applicable

2.3 Basic safety instructions

2.3.1 Product safety

The machine conforms to state-of-the-art technology and the recognised safety regulations. Nonetheless, hazards may occur.

- ▶ Operate the machine only in compliance with the operation manual.
- ▶ During machine handling, observe the safety instructions and warning notices that precede each action.

All modifications and alterations to the product are reserved for persons authorised by HOBART.

2.3.2 Personnel qualification

- ▶ Observe the regulations on occupational health and safety.
- ▶ Carefully read through the Operation Manual before use.

Ecomax Plus H 615

Safety instructions and regulations

Activity	User group	Qualification/training
Installation	Qualified personnel	Hobart Service or an electrically qualified person trained by Hobart or a competent person acc. to the German technical regulations for occupational safety (TRBS 1203) trained by Hobart
	Trainees	Only under professional supervision and examination
Commissioning	Qualified personnel	Hobart Service or an electrically qualified person trained by Hobart or a competent person acc. to the German technical regulations for occupational safety (TRBS 1203) trained by Hobart
	Trainees	Only under professional supervision and examination
Work on electrical system	Qualified personnel	Hobart Service or an electrically qualified person trained by Hobart or a competent person acc. to the German technical regulations for occupational safety (TRBS 1203) trained by Hobart
Operation	Operating personnel and persons over the age of 14	Only under supervision and after instruction by the operator on the basis of the Operation Manual, instructions on dangers
	Handicapped individuals	The suitability must be assessed by the operator on an individual basis
	Persons up to the age of 13	Persons up to the age of 13 are not suited for machine operation
Maintenance, repair	Qualified personnel	Hobart Service or an electrically qualified person trained by Hobart or a competent person acc. to the German technical regulations for occupational safety (TRBS 1203) trained by Hobart
	Trainees	Only under professional supervision and examination

2.3.3 Product-specific hazards

Avoid body parts being crushed or knocked:

- ▶ Observe the instructions on the packaging for storage, lifting or transporting.
- ▶ Do not reach into the hinge while closing the front door.
- ▶ The machine must be secured against tipping over when set up in a freestanding position.

Avoid risk of explosion:

- ▶ Do not install machine in a potentially explosive location.

Avoid electric shock, fire risk:

- ▶ Do not allow water to flow under live components.
 - Make sure the machine is correctly stored (see frost damage section 2.4).
 - Make sure that the machine does not overflow when being filled.
- ▶ Do not damage the connection cable while unpacking.
- ▶ Have the machine connected to the power supply by qualified personnel.
- ▶ Have all modifications to the machine carried out by qualified personnel.
- ▶ Have additional feed tanks mounted by qualified personnel.
- ▶ Do not operate the machine unsupervised.

Avoid fire risk:

- ▶ Do not allow water to flow under live components.

- Make sure the machine is correctly stored (see frost damage section 2.4).
- Make sure that the machine does not overflow when being filled.
- ▶ Have the machine connected to the power supply by qualified personnel.
- ▶ Have all modifications to the machine carried out by qualified personnel.

Avoid chemical burns, sensitisation of the skin, poisoning:

- ▶ Wear protective equipment (gloves, safety goggles, protective clothing) when handling chemicals.
- ▶ Use only suitable chemicals. Observe the manufacturer's data.
- ▶ Have chemical sensor system set by authorised trained service technicians.
- ▶ Do not open the machine during operation, wait for the program to finish.
- ▶ Disconnect the machine from the mains prior to cleaning.
- ▶ For cleaning, wear protective equipment (gloves, safety goggles, protective clothing) when touching parts contaminated by detergent.

Avoid burns, scalds (to the hands):

- ▶ Do not open the machine during operation or the evaporation phase, wait for the programme to finish. Otherwise, hot water could spray out.
- ▶ Disconnect the machine from the mains prior to cleaning.

Avoid slipping:

Moisture can build up on the floor around the machine.

- ▶ Provide a floor covering that does not pose a risk of slipping when wet.

Residues on the wash ware, hygiene regulations not maintained:

- ▶ Hygiene regulations must be observed and/or demonstrated in accordance with the national provisions.

2.3.4 Additional hazards

Potential hazards caused by operating resources to be used can be found in the enclosed safety datasheets. Workplaces must be marked accordingly.

2.4 Property damage

Avoid frost damage:

Temperatures below 0°C lead to functional damage.

- ▶ Before storing below 0°C, empty residual water in hoses, tank and boiler.
- ▶ Prior to restart, store the machine at room temperature (min. 15°C) for 24h.

Avoid water damage:

- ▶ Do not operate the machine without supervision.
- ▶ Close on-site shut-off valves at the end of operation.

3 Product description

3.1 Intended purpose

The machine is an item of technical equipment intended solely for commercial dishwashing.

The machine is designed solely for cleaning crockery (porcelain, glass, ceramic, temperature-resistant plastics or stainless steel or similar) from the food industry.

Not for washing:

Ecomax Plus H 615

Controls

- Containers that do not come into contact with foodstuffs, such as ashtrays, electric appliances etc.
- Animals or textiles
- Foodstuffs intended for further consumption

3.2 Designation

The rating plate is located at the side of the machine and contains the following information: model, serial number, date of manufacture, country of manufacture, voltage, connection rating, design-state number and CE mark.

3.3 Technical data

Dimensions (H x W x D)	1,510 x 635 x 742 mm
Water consumption per basket	2.2 l
Power supply	see rating plate
Total loading	
Fuse protection	
Tank capacity (l)	21 (23 for model H615)
Rack height	440
Noise emission dB (A) (workplace-related emission value)	67
Weight (kg)	100

4 Controls

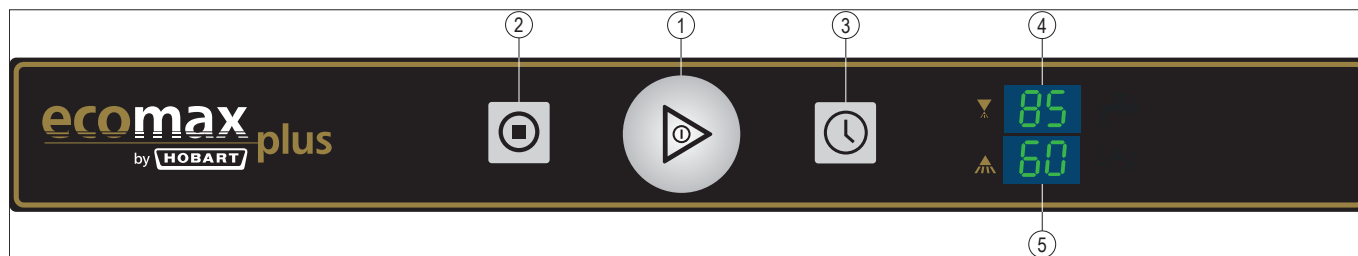

①	ON/OFF button	Pressing this button switches the machine on. Holding the button for 3 seconds activates the automatic drain and self-cleaning programme and switches off the machine. After switch off, however, the machine is not voltage free!
②	STOP button	In case of handling errors or machine faults, this button can be used to switch off the machine immediately without prior pump out. After switch off, however, the machine is not voltage free!
③	Programme selection button	Press the button to choose between different programmes.
④	Temperature display, rinsing	Standard setting shows the maximum temperature reached during the last wash programme.
⑤	Temperature display, washing	

5 Installation

5.1 Special safety instructions

WARNING!



Risk of electric shock, fire hazard

Frost damage can lead to water flowing over live components and thus to injuries from electric shock or fire.

- ▶ Make sure the machine is correctly stored (see frost damage section 2.4).

CAUTION!



Risk of being crushed or knocked

When being lifted or transported, the machine can overturn or fall and cause injury.

- ▶ Observe the instructions on the packaging for storage, lifting or transporting.

WARNING!



Risk of explosion

Installing the machine in a potentially explosive location can cause explosion and serious injury from ejected parts.

- ▶ Do not install machine in a potentially explosive location.

NOTICE!

Temperatures below 0°C during transport/storage cause function impairments.

- ▶ Prior to installation, store the machine at room temperature (min. 15°C) for 24h.

5.2 Transporting to the installation location

- ▶ If possible, transport the machine in its packaging and on the pallet.
- ▶ Use suitable transport means (elevating truck, crane etc.).
- ▶ If using a forklift, shim the machine with wooden trusses.

5.3 Removing the packaging

CAUTION!



Risk of electric shock, fire hazard

When the machine is unpacked, the connection cable can become damaged and cause injury from electric shock or fire.

- ▶ Do not damage the connection cable while unpacking the machine.

- ▶ Remove packaging materials and accessories from the machine.
- ▶ Inspect the machine for possible transport damage.

Ecomax Plus H 615

Installation

5.4 Installing the machine

⚠ WARNING!



Risk of electric shock, fire hazard

Water ingress can cause short circuit and mortal danger from electric shock and fire.

- ▶ As a protection against penetrating water, the rear side of the machine must be sealed.
- ▶ If this cannot be guaranteed, a back covering must be also ordered.

⚠ WARNING!



Risk of being crushed or knocked

The machine may tip over when set up in a freestanding position.

- ▶ The machine must be secured against tipping over when set up in a freestanding position.

- ▶ Seal the machine against the wall, or attach the optionally-available back covering.
- ▶ Cut-outs in the rear machine frame for supply lines etc., must also be sealed (sealing kit 01-539610-001 optionally available).
- ▶ Align machine by turning the adjusting feet by using a spirit level.

Installing the machine in the corner:

- ▶ Maintain a side wall clearance of 107 mm.

Installing the machine in a room:

- ▶ Attach the optionally-available back covering.

Converting to corner operation:

- ▶ Modify the basket guide rails in accordance with the pass-through direction (see arrows).
Remove the front side guides by loosening the screws.

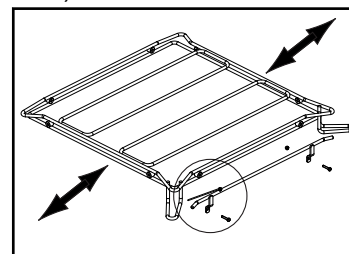

- ▶ Re-mount the side guide in accordance with the pass-through direction.

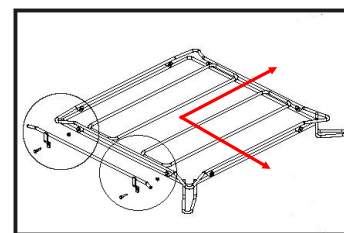

5.5 Connecting to the power supply

⚠ WARNING!



Risk of electric shock

Failure to connect properly to the power supply can cause mortal danger from electric shock.

- ▶ Have the machine connected to the power supply only by qualified personnel.
- ▶ Take cable measurement DGUV V3.

NOTE: To guarantee the electrical safety of the machine, it must be connected to a protective earthing equipment conductor installed as specified. In addition, the machine must be connected on site to the equipotential bonding connection. The connecting screw (⚡) provided for this purpose is located next to the cable inlet.

These fundamental safety requirements and the professional design of the on-site installation must be verified by a qualified electrician.

Hobart does not accept any liability for damage caused by improper installation! Any applicable local installation instructions must be observed!

The mains cable must be connected via a cut-out device (main switch or accessible plug device).

Modification to an alternative power supply is possible as per the variants on the circuit diagram. Connection diagrams are located adjacent to the connection terminals.

5.6 Connecting the water

NOTICE!

Property damage

The use of old hose sets for connection to the water supply facility can cause water damage.

- ▶ The included connection hose must be used for connection to the water supply facility.
- ▶ Old hose sets cannot be reused.

NOTE: The machine must be operated with potable water.

- ▶ If possible, connect to warm water (max. 60 °C).

Water hardness:

- Machines without softener: max. 1 °d = 0.18 mmol/l.
- Machines with softener: max. 30 °d = 5.3 mmol/l.

Flow pressure:

- Machines without softener: 0.5 – 10 bar
- Machines with softener: 0.8 – 10 bar
- If the flow pressure is higher: provide pressure reducing valve.

- ▶ Connect the union nut (3/4" thread) of the water supply hose to the site shut off valve.
- ▶ Do not kink or cut the water supply hose.
- ▶ Any required extension must be executed using a suitable pressure hose, e.g. 324088-1.

5.7 Connecting the drain

Machines with drain pump

- ▶ Do not kink or lay the drain hose loose on the ground.

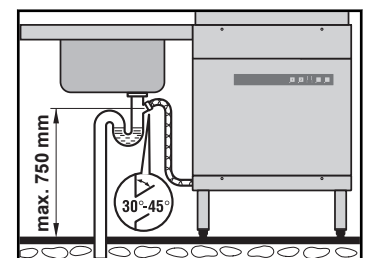

The connection between machine and site drain must not exceed the max. height of 0,75 m.

Machines without drain pump

- ▶ Ensure gravity drain.
- ▶ Do not kink drain hose.

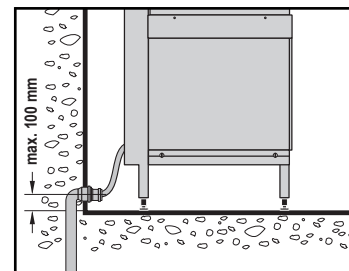

For these machine types, a floor drain is mandatory. Otherwise, residual water may remain in the tank and hose.

5.8 Connecting the dispenser

Some model variants are factory-equipped with integrated dispensers. When converting or installing different dispensers, make the connection as follows.

- ▶ Drain tank.
- ▶ Turn off on site main switch or remove the plug.
- ▶ Remove frontal covering.



Connecting the liquid dispenser:

- ▶ A metering nipple is available on top of the boiler for dispensing rinse aid.
- ▶ For detergent dosing, connect the hose (PVC / Ø 6 mm outside × Ø 4 mm inside) between the pressure side of the dispenser and the metering nipple (A) on the wash tank, secure with hose clamp.

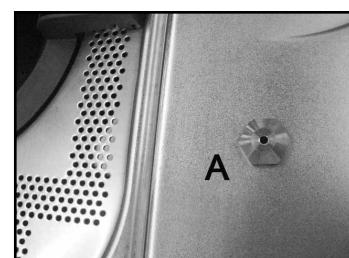

- ▶ Install dispenser or mount externally.

To connect a powder or solid detergent dispenser:

- ▶ Remove the side cover (depending on left or right connection).
- ▶ Break out sheet perforation on the sheet outer jacket.

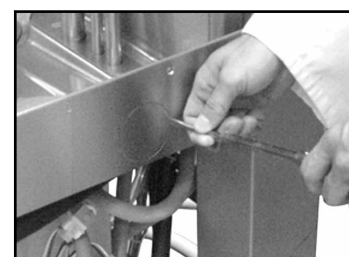

- ▶ Drill out the inner tank wall behind according to the required connection diameter.

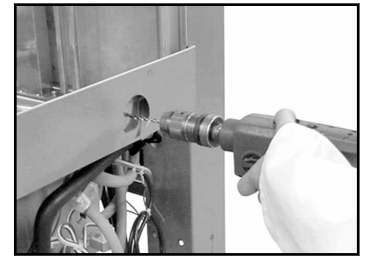

- ▶ Screw the dosing connection tightly to the tank wall.
- ▶ Connect the plug of the cable harness to the dispenser (max. 100 VA).

Installing the connectivity probe:

- ▶ Conductivity probe should be installed at the flat part of tank bottom.
- ▶ Drill out the tank according to the probe diameter.

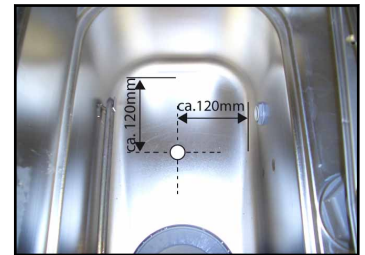

- ▶ Replace cover(s).
- ▶ Turn on site main switch or insert the plug.
- ▶ Set the dispenser and the sensor system.

6 Commissioning

6.1 Special safety instructions

NOTE: Before commissioning the machine, the relevant electrical safety checks must be performed according to the locally applicable regulations!

6.2 Setting the water hardness (optional)

NOTE: The softener must be set to the existing water hardness (ask at the local water works).

- ▶ Set hardness range according to section 8.5.

6.3 Filling the salt reservoir (optional)

NOTICE!

Property damage

Accidentally filling the salt reservoir with detergent will damage the water softener.

- ▶ Do not fill the salt reservoir with detergent.

Ecomax Plus H 615

Commissioning

- ▶ Open Hood.
- ▶ Unscrew the salt reservoir lid and add approx. 1 kg of granular (2-8 mm) regenerating salt (do not use salt tablets).

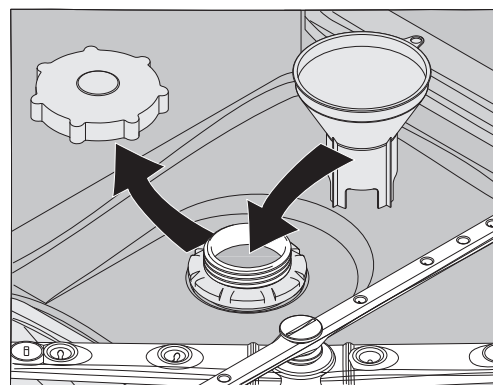

- ▶ Fill up the reservoir with potable water (only at commissioning).
- ▶ Make sure the lid seal is free of dirt and salt.
- ▶ Screw lid back on and tighten.

NOTICE!

Property damage

Salt residues on the tank floor cause corrosion damage.

- ▶ Remove salt residues by hand.
- ▶ On completion, start a wash programme to remove all traces of salt if necessary.

6.4 Prepare chemical suction

NOTE: Only for installed dosing units



We recommend the use of HOBART Hyline detergent and rinse aid.

NOTE: Mixing chemicals in the hose when exchanging chemicals can lead to crystallisation and damage to the hoses and dosing units. This is prevented by intermediary rinsing with water (see section 8.7 and 8.8). Failure to comply with this information will invalidate the guarantee and product liability.

⚠ CAUTION!



Chemical burns, sensitisation of the skin, poisoning

Improper use of chemicals or use of unsuitable chemicals can cause injury.

- ▶ Use only commercial detergent and rinse aid.
- ▶ Observe the manufacturer's application and safety instructions.

⚠ WARNING!



Chemical burns, sensitisation of the skin, poisoning

Incorrect handling of detergent or rinse aid can lead to serious injuries.

- ▶ Wear protective equipment (gloves, safety goggles, protective clothing) when handling chemicals.

6.4.1 Provisioning external chemical canisters

Preparing the detergent:

Suction height of dosing pump: max. 1.5 m.

- ▶ Place suction hose **without** colour marking at the suction valve down to the bottom of the external reservoir.

Preparing the rinse aid:

Suction height of dosing pump: max. 1.5 m.

- ▶ Place suction hose with **blue** marking at the suction valve down to the bottom of the external reservoir.

6.4.2 Hose filling

Fill the hose according to the instructions 8.7 and 8.8 .

7 Operation

7.1 Special safety instructions

⚠ CAUTION!



Chemical burns, sensitisation of the skin, poisoning, burning

If the Hood is opened during operation, vapour can escape and/or wash water can spurt out and cause injury.

- ▶ Do not open the Hood during operation, wait for the program to finish.

⚠ WARNING!



Danger of slipping

Moisture can build up around the machine and cause slipping.

- ▶ Provide a floor covering that is guaranteed to be non-slip in case of moisture.

7.2 Preparations for washing

7.2.1 Preparing the machine

- ▶ Check correct position of wash/rinse arms, strainers and if fitted stand pipe.
- ▶ Open site shut-off valve.
- ▶ Turn on main switch or insert the plug.
- ▶ Check level of detergent and rinse aid container.

Ecomax Plus H 615

Operation

- ▶ Close Hood.
- ▶ Push the ON/OFF button.

↳ During automatic filling and heating, the ON/OFF button flashes blue and the fill symbol is illuminated.

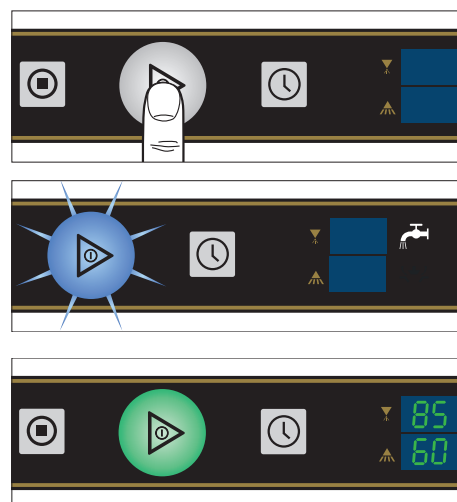

As soon as the machine is ready for operation, the ON/OFF button illuminates green and the fill symbol goes out.

7.2.2 Preparing the washware

- ▶ Remove any food residue.
- ▶ Place wash ware face down in the rack.
- ▶ Rinse off wash ware.

7.3 Displaying and selecting the program

- ▶ Pressing the programme selection button in standby mode displays the programme currently selected (P1, P2, P3 or HY).
- ▶ Pressing the programme selection button again changes the programme on a rolling basis.

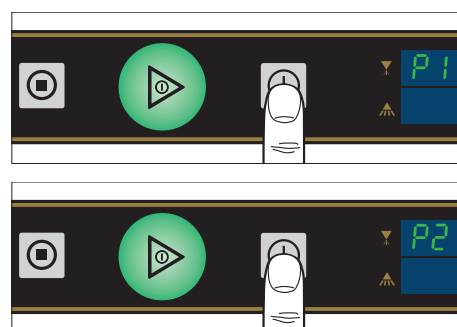

7.4 Washing

- ▶ Slide rack into the machine and close the hood.
- ↳ The ON/OFF button illuminates blue.

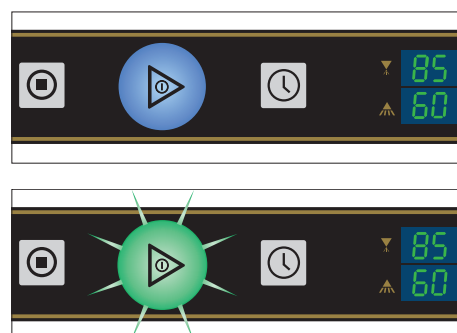

When the programme is finished, the ON/OFF button flashes green.

7.5 Switching off the machine

- ▶ In standby mode, press the ON/OFF button for 3 seconds.

↳ The ON/OFF button flashes blue, the drain symbol illuminates

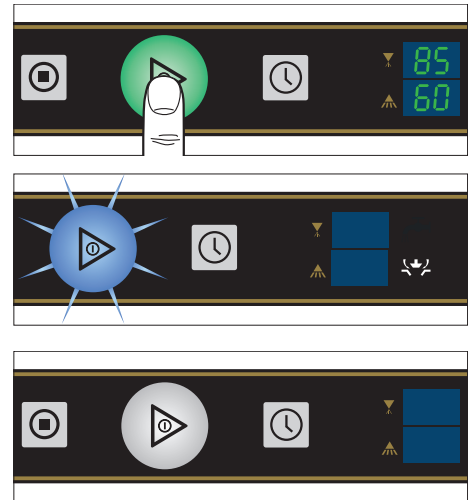

When draining is complete, the machine switches off automatically and the button illumination goes out



During pump out, the machine interior is cleaned automatically. Then remove any coarse residues manually.

When the machine has switched off:

- ▶ Turn off main switch or remove the plug.
- ▶ Close on-site shut-off valve.

7.6 Executing daily cleaning

NOTICE!

Property damage

The use of unsuitable agents can cause corrosion or damage to the surfaces.

- ▶ Do not use any chlorine-containing, acidic or metal-containing additives to clean the machine.
- ▶ Do not use metal sponges.

- ▶ Open hood.
- ▶ Remove sieves and clean. **Make sure that food debris does not enter pump intake!**
- ▶ Clean machine areas that cannot be reached by the water circulation of the self cleaner (hood labyrinth, rear side riser pipe, etc.).
- ▶ Replace strainer.
- ▶ Leave the hood open for ventilation.

7.7 Executing weekly cleaning

- ▶ Release the screw fastener on the wash and rinse arms, remove the wash and rinse arms and clean.
- ▶ Replace the wash and rinse arms.

7.8 Executing hygiene cleaning

After reaching a predefined number of rinse cycles, the notice "hY" is shown on the display and the ON/OFF button flashes red/green. This indicates that an automatic hygiene clean of the machine interior should be executed.

Ecomax Plus H 615

Settings

- ▶ Before end of operation, remove the rack and place 2 HOBART hygiene tabs in the machine interior.
- ▶ Tap the programme selection button.

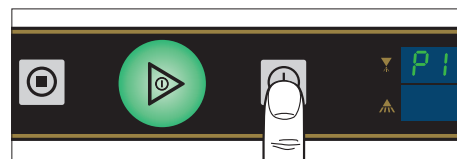

- ▶ Select hygiene programme "HY".

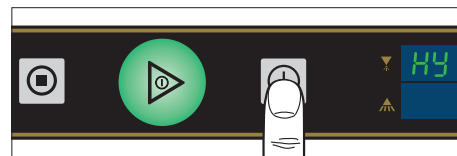

- ▶ Close hood.
 - ↳ While the hygiene programme is running (duration approx. 10 minutes), the ON/OFF button illuminates blue.

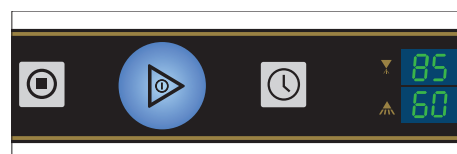

- ↳ Finally, the machine drains and switches off automatically.
- ↳ The button illumination goes out.



If necessary, hygiene clean should be executed before the pre-set number of wash cycles is reached. With regular use, the machine interior will remain free of soil and dirt deposits.

8 Settings

8.1 Overview of operator menu

Menu item	Function
01 Detergent/dosage amount	Setting
02 Rinse aid/dosage amount	Setting
03 Water hardness	Setting
04 Wash cycles	Display
05 Hose filling detergent	For commissioning and replacement of the canister
06 Hose filling rinse aid	For commissioning and replacement of the canister
07 - 10 External water treatment	Reset Remaining capacity Activate/deactivate Output capacity
11 / 12 Temperatures	Standard / Thermolabel 71° Display

8.2 Open operator menu and make settings

NOTE: Possible only when the machine is switched off.

To switch the machine off if necessary, press the Abort button.

► Open Hood.

► Press and hold the Abort button and briefly press the ON/OFF button at the same time.

↳ First menu item (01) is shown flashing

► Close hood.

After closing the hood, you can navigate between the menu items. The top line of the display shows the menu number. The bottom line shows the setting value.

- Pressing the programme selection button opens the next menu item.
- Pressing the ON/OFF button (3 seconds) activates a menu item. The setting value in the bottom line flashes.
- You can cancel the setting process by pressing the Abort button.
- Pressing the programme selection button once increases the value. Pressing and holding the programme selection button continually increases the value.

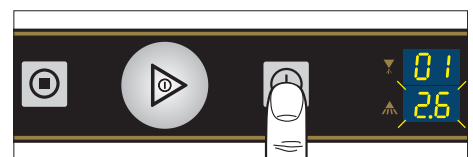
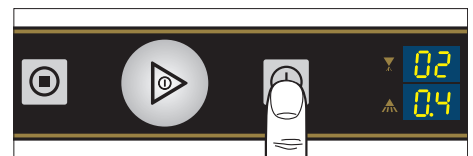
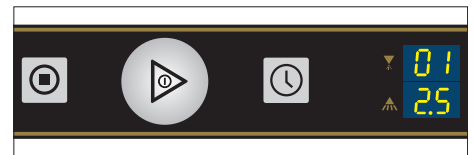
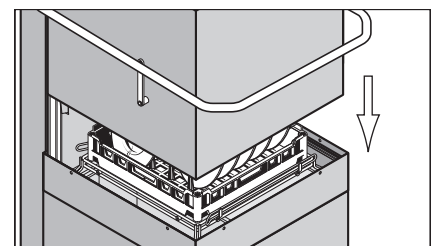
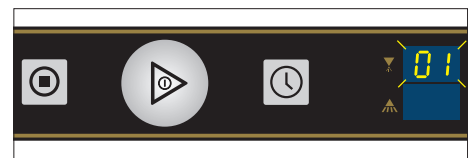
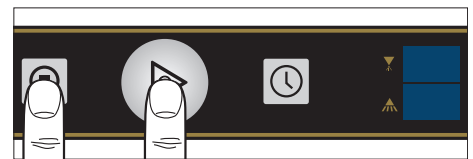
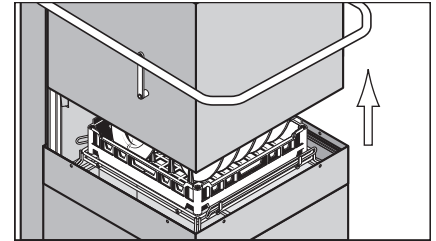
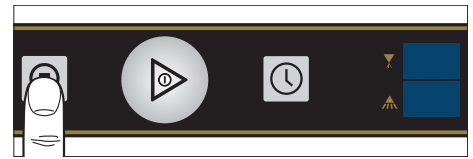

- ▶ Pressing the ON/OFF button saves the value.

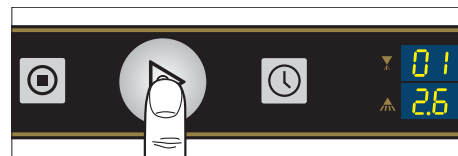

- ▶ Exit the operator menu by opening the hood or pressing the Abort button.

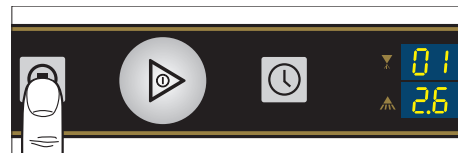

↳ The machine switches to off mode.

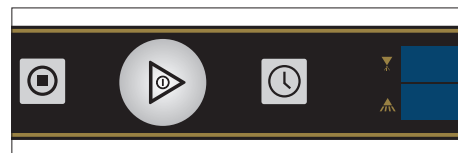

8.3 Detergent/dosage amount

Only relevant for integrated dosing units.

- ▶ Open menu and make settings (see section 8.2).
- ▶ Select menu item "01"

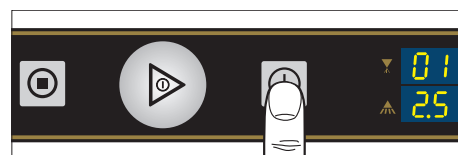

↳ The bottom display shows the current dosage value, default setting: 2.3 g/l

Setting range 0-9.5 g/l

Make and save settings according to the recommendations of the detergent supplier.

8.4 Rinse aid/dosage amount

Only relevant for integrated dosing units.

- ▶ Open menu and make settings (see section 8.2).
- ▶ Select menu item "02"

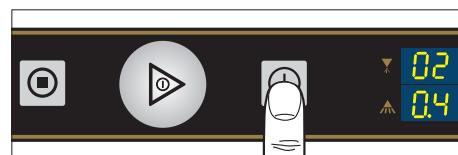

↳ The bottom display shows the current dosage value, default setting: 0.3 g/l.

Setting range 0-2 g/l

Make and save settings according to the instructions of the rinse aid supplier.

8.5 Set water hardness

Only relevant with integrated softener.

NOTE: The softener must be set to the existing water hardness (ask at the local water works).

- ▶ Open menu and make settings (see section 8.2).
- ▶ Select menu item "03"

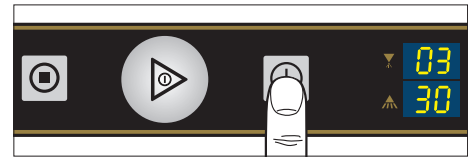

↳ The bottom display indicates the set degree of hardness in °d.

Setting range 1-30

8.6 Wash cycles

- ▶ Open menu (see section 8.2).
- ▶ Select menu item "04"

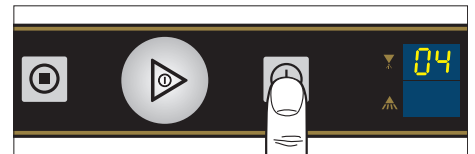

↳ After activating the menu item with the ON/OFF button, the cycle number is shown as follows (taking 003456 wash programmes as an example):



The cycle number is always shown as a 6-place sequence of numbers. First the first 2 places appear on the bottom display on a rolling basis. "1-" appears on the display at the top.

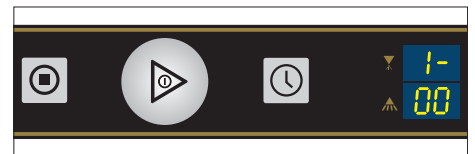

This is followed by the middle 2 places with the display "2-" above.

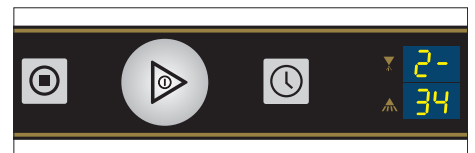

Finally, the last 2 places are shown with the display "3-" above

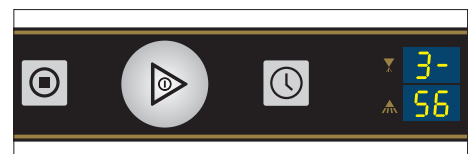

8.7 Hose filling detergent

Only relevant for integrated dosing units.

- ▶ Open menu and make settings (see section 8.2).
- ▶ Select menu item "05", bottom display shows "0".

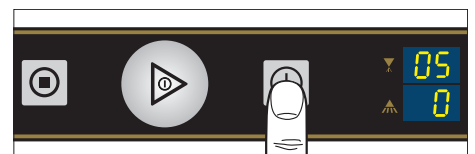

Ecomax Plus H 615

Settings

- ▶ Activate the menu item by pressing the ON/OFF button (3 seconds).



↳ The bottom display changes to a flashing "1"

- ▶ Filling does not start until the ON/OFF button is pressed again (~ 95 seconds)

↳ Before the 1, a dot flashes, indicating that the machine is currently filling with detergent

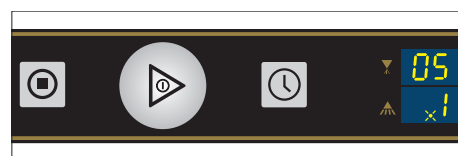

You can cancel ongoing suction by pressing the Abort button

There is no need to wait until the end once the filling process has been activated. The filling of the rinse aid hose can also start in parallel.

8.8 Hose filling rinse aid

Only relevant for integrated dosing units.

- ▶ Open menu (see section 8.2).
- ▶ Select menu item "06", bottom display shows "0".

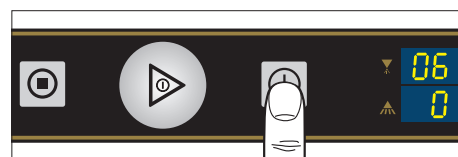

- ▶ Activate the menu item by pressing the ON/OFF button (3 seconds).



↳ The bottom display changes to a flashing "1"

- ▶ Filling does not start until the ON/OFF button is pressed again (~ 175 seconds)

↳ After the 1, a dot flashes, indicating that the machine is currently filling with rinse aid

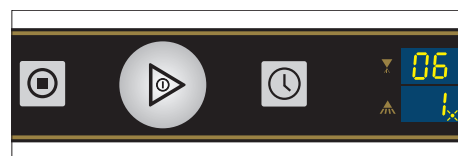

You can cancel ongoing suction by pressing the Abort button

8.9 External water treatment

Relevant only when activated (see section 8.9.3)

This can be used to monitor the capacity of an external water treatment or a pre-filter on the basis of the calculated water flow.

8.9.1 Resetting

Reset the remaining capacity to the output capacity value.

- ▶ Open menu and make settings (see section 8.2).
- ▶ Select menu item "07".

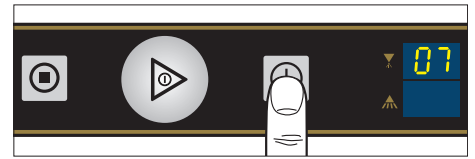

- ▶ After the menu item is activated with the ON/OFF button, a flashing "1" is shown on the bottom display.

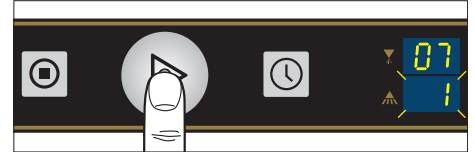

- ▶ Pressing the ON/OFF button again resets the programme.
↳ Flashing stops

8.9.2 Remaining capacity

The remaining capacity counts backwards from the set output capacity value and can be shown as follows:

- ▶ Open menu (see section 8.2).
- ▶ Select menu item "08"

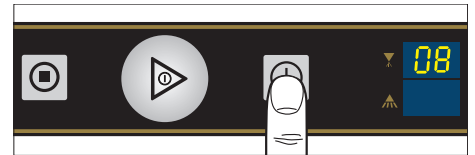

- ↳ After activating the menu item with the ON/OFF button, the remaining capacity is shown as follows (taking 003456 litres as an example):

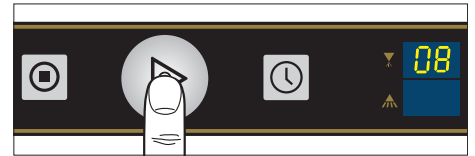

The remaining capacity is always shown as a 6-place sequence of numbers. First the first 2 places appear on the bottom display on a rolling basis. "1-" appears on the display at the top.

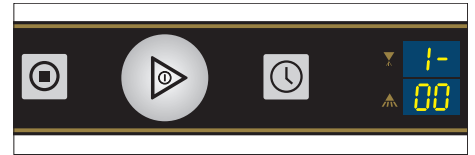

This is followed by the middle 2 places with the display "2-" above.

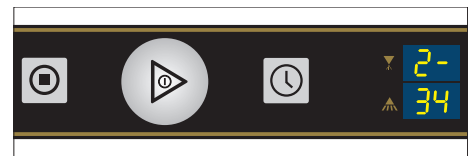

Finally, the last 2 places are shown with the display "3-" above

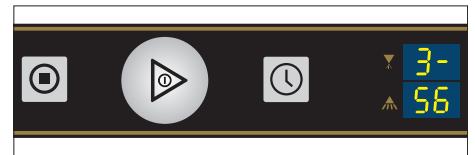

8.9.3 Activate/deactivate

This must be deactivated to use the capacity monitoring.

- ▶ Open menu and make settings (see section 8.2).
- ▶ Select menu item "09"

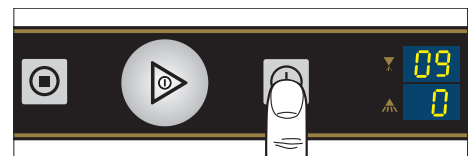

Bottom display shows the current setting:

Ecomax Plus H 615

Settings

"0" = deactivated

"1" = demineralisation cartridge (assumption: 3 l/min)

"2" = reverse osmosis system (assumption = 1.5 l/min)

8.9.4 Output capacity

Value is preset to 14000 l.

To display or change:

- ▶ Open menu and make settings (see section 8.2).
- ▶ Select menu item "10"

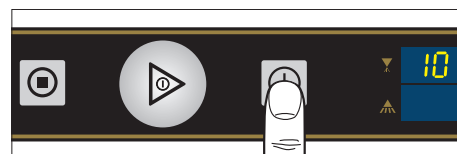

After activating the menu item with the ON/OFF button, the max. 6-place value is shown as follows (taking 014000 litres as an example):

First the first 2 places are shown on the bottom display.

"1-" appears on the display at the top.

- ▶ Change with programme selection button as needed.

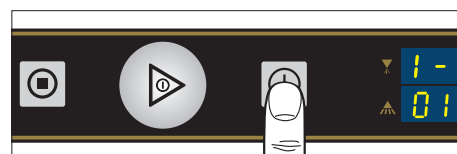

- ▶ The next two places are shown when the ON/OFF button is pressed.



- ▶ Change with programme selection button as needed.
- ▶ The last two places are shown when the ON/OFF button is pressed.

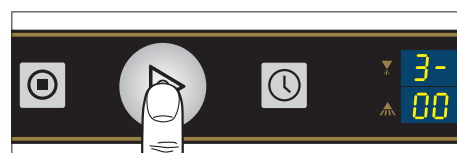

- ▶ Change with programme selection button as needed.
- ▶ Pressing the ON/OFF button again saves a changed value.

8.10 Temperatures

Here, it is possible to change from standard temperatures complying to DIN 10534 to elevated temperatures complying to NSF (Thermolabel 71° C). As a result, the program run times are extended.

- ▶ Open menu and make settings (see section 8.2).
- ▶ Select menu item "11"

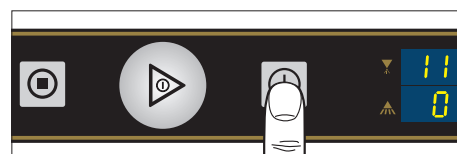

Bottom display shows the current setting:

"0" = standard temperatures

"1" = increased temperatures

8.11 Displaying the temperatures

- ▶ Open menu and make settings (see section 8.2).
- ▶ Select menu item "12"

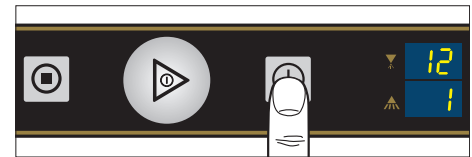

Bottom display shows the current setting:

"0" = no display of temperatures.

"1" = display shows the maximum temperature reached during the last wash programme.

"2" = display shows the current boiler and wash tank temperatures.

9 Display of faults and information

9.1 Information

The On/Off button flashes green/red alternately and the following instructions are shown with a letter combination on the display.

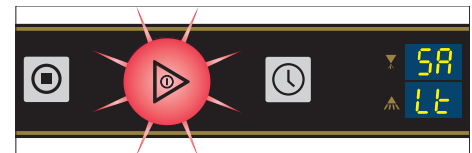

Display	Reason	Remedy
SA Lt	Regenerating salt depleted.	Refill regenerating salt (see section 6.3).
Hood	Filling, washing or pump-out programme interrupted	Close Hood.
hY	"Carry out hygiene programme" notice	Executing hygiene cleaning (see section 7.8).

9.2 Error

The ON/OFF button illuminates red and "Er" appears on the top display.

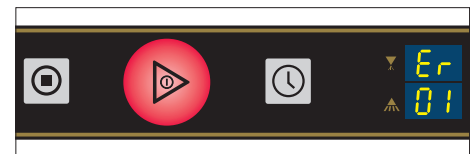

The error code is shown in the bottom display (see table).

Error code	Reason	Remedy
01	Temperature boiler sensor exceeded.	Contact your HOBART Service Partner.
02	Temperature boiler sensor undercut.	Contact your HOBART Service Partner.
03	Boiler thermostop in wash programme.	Contact your HOBART Service Partner.
05	Temperature tank sensor exceeded.	Contact your HOBART Service Partner.
06	Temperature tank sensor undercut.	Contact your HOBART Service Partner.
07	Upper limit of pressure sensor for boiler exceeded.	Contact your HOBART Service Partner.
08	Total value pressure sensor boiler undercut.	Contact your HOBART Service Partner.

Error code	Reason	Remedy
09	Total value of pressure sensor for tank exceeded.	Contact your HOBART Service Partner.
10	Total value pressure sensor tank undercut.	Contact your HOBART Service Partner.
12	Water level regulation in wash tank failed.	Contact your HOBART Service Partner.
13	Filling programme monitor pressure sensor tank.	Drain machine.
14	Wash tank draining in pump out programme for tank pressure sensor.	Clean the drain hose if necessary and pump-out the machine again.
17	Filling monitoring by impeller sensor.	Check water supply.
18	Filling monitoring by measuring the water level in the boiler.	Check water supply.
28	Fill level of wash tank too low at programme start.	The machine refills automatically and starts the programme. If the error is permanently displayed, contact your HOBART Service Partner.
29	Capacity of external water treatment unit depleted.	Replace part or full demineralisation cartridge.
31	Filling monitoring	Check water supply. Contact your HOBART Service Partner.

10 Troubleshooting guide

10.1 Poor wash result

Fault type	Possible cause	Remedy
Wash ware not clean.	Wash arm stiff (must rotate easily by hand).	Remove wash arms and clean them thoroughly. Also check water outlet from machine to wash arm is clear.
	Wash arm nozzles are clogged (visual check).	Remove wash arm, remove cleaning caps and rinse wash arm thoroughly until all soiling is removed. Replace cleaning caps.
	Rinse nozzles clogged (usually by lime deposit).	Remove rinse arms and descale them in separate container. Check site softening system for function.
	Detergent concentration is too low or too high.	Check detergent concentration setting.
	Coarse strainer clogged.	Remove, empty and clean strainer.
	Fine strainer clogged or obstructed by lime deposits.	Remove fine strainer. If heavily soiled, soak in a vinegar solution. Then clean it thoroughly with a brush until the pores are free. The fine strainer should generally be cleaned daily.
	Wrong programme selected for heavily soiled wash ware.	Select programme with longer wash cycle.
Wash ware does not dry properly.	Rinse aid dosing too low.	Increase dosage.

Fault type	Possible cause	Remedy
	Washware still greasy.	Detergent concentration too low: increase dosage. Check if detergent is appropriate. If not, choose a stronger one. Drain contaminated water and refill machine. Improve the preliminary cleaning of the washware.
	Rack is not suitable for type of dishes (sloping).	Use appropriate racks to create a sloping position which allows water to drain away from cavities.
	Washware remains in the machine too long at the end of wash cycle.	Remove washware as soon as cycle is completed to enable it to dry.
Streaks and spots on wash ware.	Rinse aid concentration too high (stripe or bubble formation).	Reduce dosage.
	Hard water or high mineral content.	Check water quality. Every local water works holds data on the composition of the water they supply and will provide these on request. Reference values: Ideal calcium value: 0 – 3°d (total hardness). Ideal mineral content value: for glasses, max. conductivity 100 µS/cm, for dishes, still viable to max. 400 µS/cm.
	Rack is not suitable for type of dishes (sloping).	Use appropriate racks to create a sloping position which allows water to drain away from cavities.
	Inadequate rinse aid dosing causes stains.	Increase rinse aid dosing.
	Machines with integrated softener: use of wrong salt (e.g. tablets).	Do not use salt tablets.

10.2 Other faults

Fault type	Potential causes	Remedy
Glasses are totally or partially cloudy.	Surface of glasses is rough and porous, this is called glass corrosion.	Use new glasses, this is not caused by a malfunction on the machine.
Glass/dish breakage.	Use of unsuitable dish or glass racks.	Use suitable racks.

11 Maintenance

In order to maintain the warranty, as well as a permanently safe, efficient, and trouble-free operation of the machine(s), the required maintenance must be carried out by authorized service technicians. We therefore recommend the conclusion of an inspection and maintenance contract, which guarantees qualified support by specially trained service technicians according to a time schedule based on the operating conditions.

Genuine spare parts must be used for repairs and wearing part replacements. Wearing parts include dosing hoses, rinse arm bearings, etc. In Germany, your HOBART machines are governed by the Ordinance on Industrial Health and Safety and must be inspected by a qualified electrician in accordance with the intervals specified by the Institute for Work and Health of the German Social Accident Insurance [DGUV V3 (BGV A3)].

12 Disposal

- ▶ The machine operator is responsible for disposing of the machine and its operating materials correctly and in accordance with environmental regulations. Observe the national and local legal provisions and regulations.



13 Product disclaimer

Installations and repairs carried out by non-authorized technicians or using non-genuine spare parts, and any technical alterations to the machine not approved by the manufacturer will invalidate the manufacturer's warranty and product liability.

HOBART reserves the right to make changes or improvements to its products without prior notice.

© HOBART GmbH, Offenburg 2023

14 Conformity



Original

EG-Konformitätserklärung

Declaration of Conformity / Déclaration de Conformité / Declaración de Conformidad / Dichiarazione di conformità / Conformiteitsverklaring / Deklaracja zgodności / Декларация соответствия / Uygunluk beyanı / Deklaracija o skladnosti / Izjava o skladnosti / Declaração de Conformidade / Prohlášení o shodě

Die alleinige Verantwortung für die Ausstellung dieser Konformitätserklärung trägt der Hersteller.

This declaration of conformity is issued under the sole responsibility of the manufacturer.
La présente déclaration de conformité est établie sous la seule responsabilité du fabricant.
La presente declaración de conformidad se expide bajo la exclusiva responsabilidad del fabricante.
La presente dichiarazione di conformità è rilasciata sotto la responsabilità esclusiva del fabbricante.
Deze conformiteitsverklaring wordt verstrekt onder volledige verantwoordelijkheid van de fabrikant.
Niniejsza deklaracja zgodności wydana zostaje na wyłączną odpowiedzialność producenta.

Эта декларация соответствия выдается под исключительную ответственность производителя.
Bu uygunluk beyanı, yalnızca üreticinin sorumluluğunda alınmış olmalıdır.
Ova izjava o skladnosti izdaje se na isključivu odgovornost proizvođača.
Ta izjava o skladnosti je izdana na lastno odgovornost proizvajalca.
A presente declaração de conformidade é emitida sob a exclusiva responsabilidade do fabricante.
Toto prohlášení o shodě se vydává na výhradní odpovědnost výrobce.

Maschine:	Geschirrspülmaschine	Hersteller / Dokumentationsbevollmächtigter:	HOBART GMBH / Verena Wiedenhöfer
Machine:	Dishwasher	Manufacturer / authorized to compile the technical file:	Robert-Bosch-Straße 17
Machine:	Machine à laver la vaisselle	Fabricant / autorisée à constituer le dossier technique:	77656 Offenburg / Germany
Máquina:	Lavavajillas	Fabricante / autorizado para unificar la información técnica:	
Macchina:	Lavastoviglie	Fabbricante / Responsabile della documentazione:	
Machine:	Vaatwasmachine	Fabrikant / Geautoriseerd om de technische documentatie samen te stellen:	
Uzřadzenie:	Zmywarka do naczyń	Producent / autoryzowany przedstawiciel:	
Машина:	Посудомоечная машина	Изготовитель / ответственный за составление документации:	
Máquina:	Bulaják mákinesi	Üretici / Dokümantasyon yetkilisi:	
Stroj:	Perilica posuda	Proizvođač / ovlašten za sastavljanje tehničkog spisa:	
Stroj:	Stroj za pranje posode	Proizvajalec / pooblaščen za dokumentacijo:	
Máquina:	Máquina lava-loiça	Fabricante / Responsável pela documentação:	
Stroj:	Myčka na nádobí	Výrobce / osoba zplnomocnená sestavením dokumentace:	
Model:	Eco+H615 - Serie HOBART615	Design State: AMB-14-04	Serial No.: 86 74 3xxxx

Hermit bestätigen wir, dass die genannte Maschine entsprechend den nachfolgend aufgeführten Normen gefertigt und geprüft worden ist.
Herewith our confirmed machine has been manufactured and tested in accordance with the following standards.

Par la présente, nous déclarons que la machine citée ci-dessus a été fabriquée et testée en conformité aux normes.
Por la siguiente confirmamos que la máquina mencionada ha sido fabricada conforme a las siguientes normas.
Con la presente confermiamo che la macchina indicata è stata costruita in conformità alle norme di seguito riportate.
Hierbij bevestigen wij dat de genoemde machine is gefabriceerd en getest volgens de hiervolgende voorwaarden.
Niniejszym deklarujemy, że wymieniony produkt spełnia wymogi następujących norm.
Настоящим мы подтверждаем, что указанная машина изготовлена в соответствии с приведенными ниже нормами.
Išbu belge ile belirtilen makinenin aşağıda listelenen normlar doğrultusunda hazırlanmış beyan ederiz.
Ovimе потврђујемо да је горе наведени stroj произведен и тестiran sukladno sljedećim standardima.
S tem izjavljamo, da je naveden stroj izdelan in preizkušen v skladu s spodaj navedenimi standardi.
Com a presente declaramos que a máquina supracitada foi construída e inspeccionada segundo as normas referidas a seguir.
Tímto potvrzujeme, že uvedený stroj byl vyroben a zkontrolován podle následujících norem.

DIN SPEC 10534:2019-02
EN 55014-1:2017/A11:2020
EN 55014-2:2015
EN 60335-2-58:2005 + Cor.:2007 + A1:2008 + A11:2010 + A2:2015 + A12:2016
EN IEC 61000-6-2:2019
EN IEC 61000-6-3:2021
EN ISO 12100:2010
EN IEC 63000:2018

Die Maschine stimmt mit den folgenden Richtlinien überein:

The product complies with the following directives:
La machine est conforme aux directives fixées:
La máquina armoniza con las siguientes Directivas:
La macchina è conforme alle direttive seguenti:
Het product voldoet aan de volgende richtlijnen:
Uzřadzenie spełnia wymogi następujących dyrektyw:
Машина соответствует требованиям следующих директив:
Máquina, aşağıdaki yönetmelikler ile uyumludur:
Ovaj stroj je u skladu sa sljedećim direktivama:
Stroj ustreza zahtevam sledećih direktiv:
A máquina está em conformidade com as seguintes diretivas:
Stroj je v skladu s ustanovenimi následujících směrníc:

2006/42/EG (Maschinenrichtlinie, Machinery-Directive)
2014/30/EU (EMV-Richtlinie, EMC-Directive)
2011/65/EU (RoHS Richtlinie, RoHS Directive)

Die Schutzziele der Niederspannungsrichtlinie 2014/35/EU wurden gemäß Anhang I Nr. 1.5.1 der Maschinenrichtlinie 2006/42/EG eingehalten.

Protective Goals of the Low Voltage Directive 2014/35/EU are in compliance with Appendix I No 1.5.1 of the Machinery Directive 2006/42/EC.
Les objectifs de protection de la directive sur les basses tensions 2014/35/UE ont été respectés conforme à l'annexe I Nr. 1.5.1 der de la directive relative aux machines 2006/42/EC.
Directiva de protecciones de baja tensión 2014/35/UE están en acuerdo con el apéndice I No 1.5.1 de la directiva de maquinaria 2006/42/EC.
Gli obiettivi di protezione della direttiva per basse tensioni 2014/35/UE è stata rispettata secondo allegato I n. 1.5.1 della Direttiva per macchine 2006/42/EC.
De veiligheidsdoelstellingen van de laagspanningsrichtlijn 2014/35/UE zijn nageleefd in overeenstemming met nr. 1.5.1 van bijlage I van de machine richtlijn 2006/42/EG.
Produkt spełnia wymogi bezpieczeństwa dyrektywy niskonapięciowej 2014/35/UE, zgodnie z załącznikiem I nr. 1.5.1 dyrektywy maszynowej 2006/42/WE.
Цели, охраняемые Директивой по высоковольтному оборудованию 2014/35/ЕU, соблюдены в соответствии с приложением № 1.5.1 Директивы по машинному оборудованию 2006/42/EC.
Alçak Gerilim Yönetmeliği 2014/35/UE'nin koruyucu hedeflerine, Makine Yönetmeliği 2006/42/EC, ek I no. 1.5.1'e göre uyumludur.
Sigurnosni ciljevi direktive o niskom naponu 2014/35/UE udovoljavaju dodatku I br. 1.5.1. Direktive o strojevima 2006/42/EC.
Uporabljene so zaščitni cilji Direktive o nizki napetosti 2014/35/UE v skladu s priložilo I, št. 1.5.1 Direktive o strojih 2006/42/ES.
Os objetivos de proteção da Diretiva de Baixa Tensão 2014/35/UE foram cumpridos de acordo com o Apêndice I, n.º 1.5.1 da Diretiva de Máquinas 2006/42/CE.
Cile ochrany dle niskonapěťové směrnice 2014/35/EU byly splněny dle přílohy I č. 1.5.1 směrnice o strojních zařízeních 2006/42/ES.

Bestätigt durch:
Confirmed by:

Offenburg, 21.11.2022

ppa.

Harald Disch
Direktor Produktentwicklung Europa
Director Warewash Engineering Europe



Original

Declaration of Conformity

Authorized to compile the technical file:

HOBART UK
Southgate Way, Orton Southgate,
Peterborough, PE2 6GN, UK

This declaration of conformity is issued under the sole responsibility of the manufacturer.

Machine: *Dishwasher*

Trade mark: ecomax by HOBART

Model: Eco+H615 - Serie
HOBART615 - Serie

Design State: AMB-14-04

Serial No.: 86 74 3xxxx

Herewith our confirmation that the named machine has been manufactured and tested in accordance with the following designated standards.

- DIN SPEC 10534:2019-02
- BS EN 55014-1:2017+A11:2020
- BS EN 55014-2:2015
- BS EN 60335-2-58:2005+A12:2016
- BS EN IEC 61000-6-2:2019
- BS EN IEC 61000-6-3:2021
- BS EN ISO 12100:2010
- BS EN IEC 63000:2018

The product complies with the following regulations:

- SI 2008/1597 (The Supply of Machinery (Safety) Regulations 2008)
- SI 2016/1091 (The Electromagnetic Compatibility Regulations 2016)
- SI 2012/3032 (The Restriction of the Use of Certain Hazardous Substances in Electrical and Electronic Equipment Regulations 2012)

Protective Goals of the Electrical Equipment (Safety) Regulations 2016 (SI 2016/1101) are in compliance with Appendix I No 1.5.1 of the Supply of Machinery (Safety) Regulations 2008 (SI 2008/1597).

Confirmed by:

Offenburg, 21.11.2022

ppa. *Harald Disch*

Harald Disch
Director Warewash Engineering Europe

HOBART GmbH

ecomax by HOBART
Robert-Bosch-Str. 17
77656 Offenburg
Deutschland
Tel.: +49 (0)1803 66 29
Fax: +49 (0)1803 63 29.600-23 19
E-Mail: info@ecomaxbyhobart.de
Internet: www.ecomaxbyhobart.de

HOBART Export

Robert-Bosch-Str. 17
77656 Offenburg
Germany
Phone: +49 (0)781.600-2820
Fax: +49 (0)781.600-2819
E-Mail: info-export@hobart.de
Internet: www.hobart-export.com

Hobart UK.

Southgate Way,
Orton Southgate,
Peterborough
PE2 6GN
United Kingdom
Tel.: +44 (0)844 888 7777
Republic of Ireland: +353 (0)1246 0248
Fax: +44 (0)1733 361 347
E-mail: sales@hobartuk.com
Internet: www.hobartuk.com

Compagnie HOBART SAS

Allée du 1er mai
77183 Croissy Beaubourg
FRANCE
Tel: +33 (0)1 64 11 60 00
Fax: +33 (0)1 64 11 60 10
E-mail: contact@hobart.fr
Internet: www.hobart.fr

Hobart Nederland BV

Pompmolenlaan 12
3447 GK Woerden
Telefoon +31 (0)348 462626
Fax: +31 (0)348 430117
E-mail: info@hobartnederland.nl
Internet: www.hobartnederland.nl

Hobart Foster Belgium bvba/sprl

Industriestraat 6
1910 Kampenhout
Telefoon +32 (0) 16.60.60.40
Fax +32 (0) 16.60.59.88
E-mail: info@hobart.be
Internet: www.hobart.be

Hobart Norge

Gamle Drammenvei 120
N-1363 Høvik
Tlf.: +47-67109800
Fax.: +47-67109801
E-post: post@hobart.no
Hjemmeside: www.hobart.no

Hobart Scandinavia ApS

Håndværkerbyen 27
2670 Greve
Danmark
Tlf.: +45 4390 5012
Fax.: +45 4390 5002
E-mail: salg@hobart.dk
Internet: www.hobart.dk

Hobart Sweden/Finland

Tel: +46 8 584 50 920
E-mail: info@hobart.se
Internet: www.hobart.se

Australia

Hobart Food Equipment
Unit 1 / 2 Picken Street,
Silverwater NSW, 2128
Tel: +61 1800 462 278
Fax: +61 02 9714 0222
E-mail: sales@hobartfood.com.au
Internet: www.hobartfood.com.au

HOBART China

15th Floor, Building A
New Caohejing International Business
Center
391 Gui Ping Road
Shanghai, 200233
Telephone: +86 (0)21 34612000
Fax: +86 (0)21 34617166
Internet: www.hobartchina.com

HOBART Korea LLC

7th Floor, Woonsan Bldg, 108, Bangi-dong
Songpa-gu, Seoul 138-050
Korea
Telephone: +82 2 34 43 69 01
Fax: +82 2 34 43 69 05
E-mail: contact@hobart.co.kr
Internet: www.hobart.co.kr

HOBART (Japan) K.K.

6-16-16 Minami-Oi, Shinagawa-ku,
Tokyo 140-0013
Japan
Telephone: +81 3 5767 8670
Fax: +81 3 5767 8675
E-mail: info@hobart.co.jp
Internet: www.hobart.co.jp

Hobart International (S) Pte Ltd

158, Kallang Way, #06-03/05
Singapore 349245
Telephone: +65 6846 7117
Fax: +65 6846 0991
E-mail: enquiry@hobart.com.sg
Internet: http://www.hobart.com.sg

Hobart Thailand

43 Thai CC Tower Building,
31st FL, Room No. 310-311,
South Sathorn Rd., Yannawa,
Sathorn, Bangkok, 10120
Thailand
Telephone: +66(0)2-675-6279-81
Fax: +66(0)2-675-6282
E-mail: enquiry@hobartthailand.com
Internet: http://www.hobartthailand.com

ITW India Pvt Ltd.

501-502 Vipul Trade Centre
Sector 48 Sohna Road
Gurgaon 122001
Telephone: +91 124 4245430
Fax: +91 124 4245432