

MODEL: **HyGenikx HGX-T-10-S**



HYGENIKX+

HyGenikx Air & Surface Hygiene Amplifier with 10m² coverage. Titanium finish. For use in General areas such as washrooms, front of house and changing areas

Area of use: General
Range of cover: 10m²
Colour finish: Titanium finish

FEATURES & BENEFITS

- Kills Escherichia coli (E. coli), Staphylococcus aureus (S. aureus), Clostridium difficile (C. difficile), Aspergillus fumigatus, and other primary sources of infections
- Significantly improves hygiene standards to levels impossible to maintain with traditional cleaning methods alone
- Eliminates bacteria, viruses, moulds, fungi and volatile organic compounds (VOCs), both in the air and on exposed surfaces, even in the hardest to reach places
- Safe to use and for the environment
- Eradicates unpleasant odours by tackling them at source
- Proven to deplete harmful Listeria monocytogenes and Listeria innocua from surfaces to undetectable levels
- Improves infection control for staff and customers
- Proven to reduce spoilage by extending the shelf-life of perishable food on average by 58%, and up 150% for certain produce
- Low energy consumption, only 85 watt
- Easy to change lamp and backup battery, requires no onsite engineer
- Power via a plug that allows flexible installation and easy connection to existing sockets or to switched spurs

TECHNICAL INFO

- Combines technologies: Germicidal Oxidation, Germicidal Irradiation, Dual waveband Plasma Quattro
- Services: 240/50/1. Uninterrupted supply - 24 hour operation required. High level
- Dimensions: 400 x 135 x 110mm
- EC declaration of conformity
- CE mark
- Low voltage directive 2014/35/EU
- EN 60335-1:2012 +A13:2017
- EN 60335-2-59:2003 +A1:2006 +A2:2009
- EN 62233:2008
- Class 1 certified for electrical insulation
- Designed and manufactured to EUOTA requirements

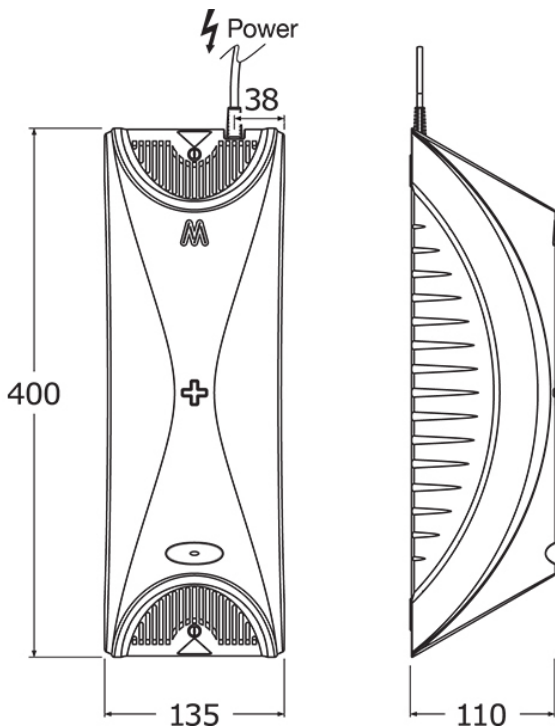

Dimensions are in millimeters. If a Cad file is required please visit www.mechline.com.

MAINTENANCE & CLEANING

Cleaning chrome: Do not use abrasive, chlorine or acid-based cleaning products. Avoid contact with concentrated bleach. Clean with soapy water using a cloth or sponge.



MECHLINE DEVELOPMENTS LIMITED
 Tel: +44 (0)1908 261511 | Email: info@mechline.com | Web: www.mechline.com