



DF46 - Silverlink 600 Electric Counter-top Single Tank Fryer - 2 Baskets - W 450 mm - 6.0 kW

The Silverlink 600 Electric Single Tank Counter Top Fryer delivers 26kg of chips per hour and features a twin basket operation which gives you the flexibility of cooking different foods or loads simultaneously.

- ✔ Single tank fryer with twin basket operation giving you the flexibility to cook different foods or loads simultaneously, delivering 26kg of chips per hour
- ✔ Front mounted controls for safety
- ✔ Hinged elements to give easy access during cleaning
- ✔ Cool zone collects cooking debris - gives cleaner cooking results and saves money by prolonging the life of the oil
- ✔ Thermostatically controlled to give accurate cooking temperatures throughout cooking. Fail-safe top temperature cut out ensures safe operation.
- ✔ Fully moulded 304 stainless steel tank and heavy duty nickel plated baskets for the most demanding of operations
- ✔ Front drain off tap for easy removal of cooking oil

Specifications

Summary

Range Name	Silverlink 600
Power Type	Electric
Unit Type	Counter-top
Available in UK Only	No
UK Warranty	2 Years Parts and Labour Warranty
Export Warranty	Contact your local dealer
GTIN Code	5056105104629

Power and Performance

Total Power kW	6.0
Temperature Range °C	130 - 190
IP Rating	IP33
Temperature Control	Mechanical

Key Specifications

Capacity Litres	15.0
Number of Baskets	2
Number of Tanks	1
Gravity Filtration	No
Pumped Filtration	No
Drain Location	Front-mounted

Weights and Dimensions

Unit Height (External) mm	330
Unit Width (External) mm	450
Unit Depth (External) mm	632
Net Weight Kg	18

Supply Connections

Requires Installation	Yes
Requires Electrical Supply	Yes
UK 3 Pin Plug	No
Requires Hardwiring	Yes
Electrical Supply Rating Watts	6,000
Single Phase Amps	26.0
Single Phase Voltage	230
Three Phase Amps	L1=13.0 ; L2=13.0 ; L3=N/A
Three Phase Voltage	400

Shipping

Packed Weight Kg	21.7
Packed Height cm	49.5
Packed Width cm	70
Packed Depth cm	55

Available Accessories

BA96	BASKET SPUN DFSMALL
CC4	Silverlink 600 Free-standing Ambient Open-Top Pedestal with Doors - W 450 mm
CN4	Silverlink 600 Free-standing Ambient Open-Top Pedestal without Doors - W 450 mm

Available Accessories

DC03	DONUT KIT FOR DF46
HC4	Silverlink 600 Free-standing Heated Open-Top Pedestal with Doors - W 450 mm - 0.5 kW
HCL4	Silverlink 600 Free-standing Heated Pedestal with Legs and Doors - W 450 mm - 0.5 kW
SLS4	Silverlink 600 Free-standing Floor Stand - for units W 450 mm

Technical Picture

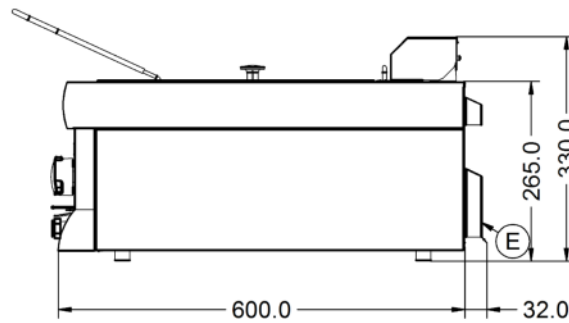
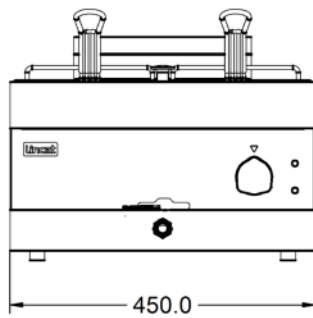
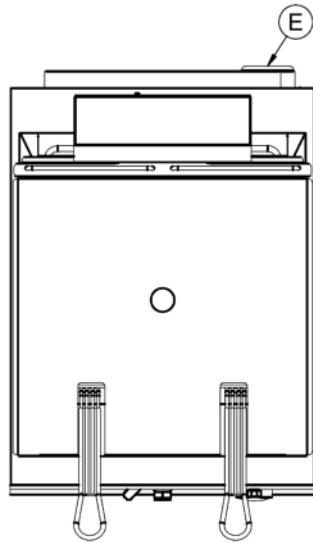



Lincat Limited

Whisby Road,
Lincoln, LN6 3QZ,
United Kingdom

Company No: 2175448

A member company of



Customer Care

Tel: +44 1522 875500
Email: care@lincat.co.uk

Export Customers

Tel: +44 1522 503250
Email: export@lincat.co.uk

Opening Hours

Monday – Friday:
8.30am – 5pm