

ARCTICA

REFRIGERATION

Portable Ice Maker Instruction Manual

Model

HEF955

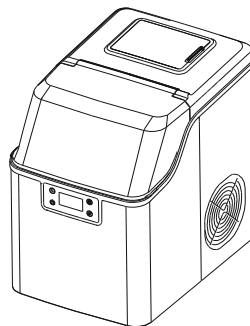

TABLE OF CONTENTS

IMPORTANT SAFETY INSTRUCTIONS	2
PREPARING YOUR ICE MAKER FOR USE	
IMPORTANT SAFETY TIPS	3-4
GETTING TO KNOW YOUR UNIT	5
OPERATING PROCEDURES & MAINTENANCE	
UNPACKING YOUR ICE MAKER	6
CONNECTING YOUR ICE MAKER	6
CLEANING AND MAINTAINING YOUR ICE MAKER	6-7
USING YOUR ICE MAKER	8-9
AUTOMATIC SELF-CLEANING PROGRAM	9
TROUBLESHOOTING	10
TECHNICAL PARAMETERS	11
DISPOSAL AND COMPLIANCE	12

IMPORTANT SAFETY INSTRUCTIONS

Your safety and the safety of others are very important.

We have provided many important safety messages manual and your appliance.
Always read and obey all safety messages.

This is the safety alert symbol:



All safety messages will follow the safety alert symbol and the word “DANGER” or “WARNING”.



DANGER



WARNING

These words mean:

You can be killed or seriously injured if you don't immediate follow instructions.

All safety messages will tell you what the potential hazard is, tell you how to reduce the chance of injury, and tell you what can happen if the instructions are not followed.

PREPARING YOUR ICE MAKER FOR USE

IMPORTANT SAFETY TIPS

When using electrical appliances, basic safety precautions should be followed to reduce the risk of fire, electric shock, and injury to persons or property. Read all instructions before using any appliance.

- This appliance can be used by children aged from 8 years and above and persons with reduced physical, sensory or mental capabilities or lack of experience and knowledge if they have been given supervision or instruction concerning use of the appliance in a safe way and understand the hazards involved. Children shall not play with the appliance. Cleaning and user maintenance shall not be made by children without supervision.
- Do not operate this, or any other appliance with a damaged cord.
If the supply cord is damaged, it must be replaced by the manufacturer or its service agent or a similarly qualified person in order to avoid a hazard.
This ice-maker must be positioned so that the plug is accessible.
Connect to properly polarized outlets only. No other appliance should be plugged into the same outlet. Be sure that the plug is fully inserted into the receptacle.
- Do not run the power cord over carpeting or other heat insulators. Do not cover the cord. Keep cord away from traffic areas, and do not submerge in water.
We do not recommend the use of an extension cord, as it may overheat and become a risk of fire. If you must use an extension cord, use **No.0.75mm² minimum size and rated no less than 16A/250V~ with a plug.**
WARNING: This appliance must be earthed.
- Unplug the ice maker before cleaning or making any repairs or servicing.
- Exercise caution and use reasonable supervision when appliance is used near children.
- Do not use your ice-maker outdoors. Place the ice-maker away from direct sunlight and make sure that there is at least 6 inches of space between the back of your unit and wall. Keep a minimum distance of 6 inches on each side of your unit free.
- Do not use other liquid to make the ice-cube other than water.
- Do not clean your ice maker with flammable fluids. The fumes can create a fire hazard or explosion.
- Do not tip over. To avoid a hazard due to instability of the appliance, it must be placed at an even or flat surface.
- **If the ice maker is brought in from outside in wintertime, give it a few hours to warm up to room temperature before plugging it in.**
- This appliance is not intended for use by persons (including children) with reduced physical, sensory or mental capabilities, or lack of experience and knowledge, unless they have been given supervision or instruction concerning use of the appliance by a person responsible for their safety.

- Children should be supervised to ensure that they do not play with the appliance.
- This appliance must be earthed.
- Do not store explosive substances such as aerosol cans with a flammable propellant in this appliance.
- This appliance is intended to be used in household and similar applications such as
 - Staff kitchen areas in shops, offices and other working environments;
 - Farm houses and by clients in hotels, motels and other residential type environments;
 - Bed and breakfast type environments;
 - Catering and similar non-retail applications.



- **Warning: Risk of fire/flammable materials used.** Please according to local regulations regarding disposal of the appliance for its flammable blowing gas.
- **WARNING:** Keep ventilation openings, in the appliance enclosure or in the built-in structure, clear of obstruction.
- **WARNING:** Do not damage the refrigerant circuit.
- **WARNING:** Do not use mechanical devices or other means to accelerate the defrosting process or ice harvesting process, other than those recommended by the manufacturer.
- **WARNING:** Do not use other type of electrical appliances inside the ice-maker.

IMPORTANT:

The wires in this mains lead are colored in accordance with the following code:

Green and yellow:	Grounding
Blue:	Neutral
Brown:	Live

- This appliance is not intended for use by persons (including children) with reduced physical, sensory or mental capabilities, or lack of experience and knowledge, unless they have been given supervision or instruction concerning use of the appliance by-a person responsible for their safety.
- Young children should be supervised to ensure that they do not play with the appliance.
- Please according to local regulations regarding disposal of the appliance for its flammable refrigerant and blowing gas. Before you scrap the appliance, please take off the doors to prevent children trapped.

GETTING TO KNOW YOUR UNIT

1. Control Panel:

A. Timer/clean button

Quickly press this button once, to enter the Timer setting program; And press this button for more than 5 seconds, to enter the Cleaning program

B. ON/OFF button

When the unit is off, press this button to turn on the unit;

When the unit is making the ice cube, press this button for more than 5 seconds, the unit will switch to ice harvest process by force.

C. LCD Display window

1. Ambient temp and ice making countdown symbol: when display show <M>, ice making countdown, when display show <°F>, means ambient temp.

2. Ice cube symbol: when the symbol is rotating, the unit is making ice cube, when the symbol flash, the unit is ice harvest.

3. Automatic self-cleaning symbol display

4. ON/OFF symbol.

5. Error code E1-Ambient temp sensor breakdown. E2- water temp sensor breakdown
E- Means ice making anomaly or the refrigerant leaked

6. Lack water warning symbol.

7. Ice full warning symbol.

8. Time setting display area. When show <H>, timer unit ON/OFF, when show <M>, setting ice making time.

D. Ice making and timer reduce.

E. Ice making and timer increase.

2. Ice basket

3. Evaporator

4. Water separator pipe

5. Unit top cover

6. Cover for the water reservoir

7. Support seat for water bottle (Optional, special for the unit supplied by bottled water)

8. Hot Air Outlet

9. Water draining cap: To draining out the water from unit

10. Ice scoop

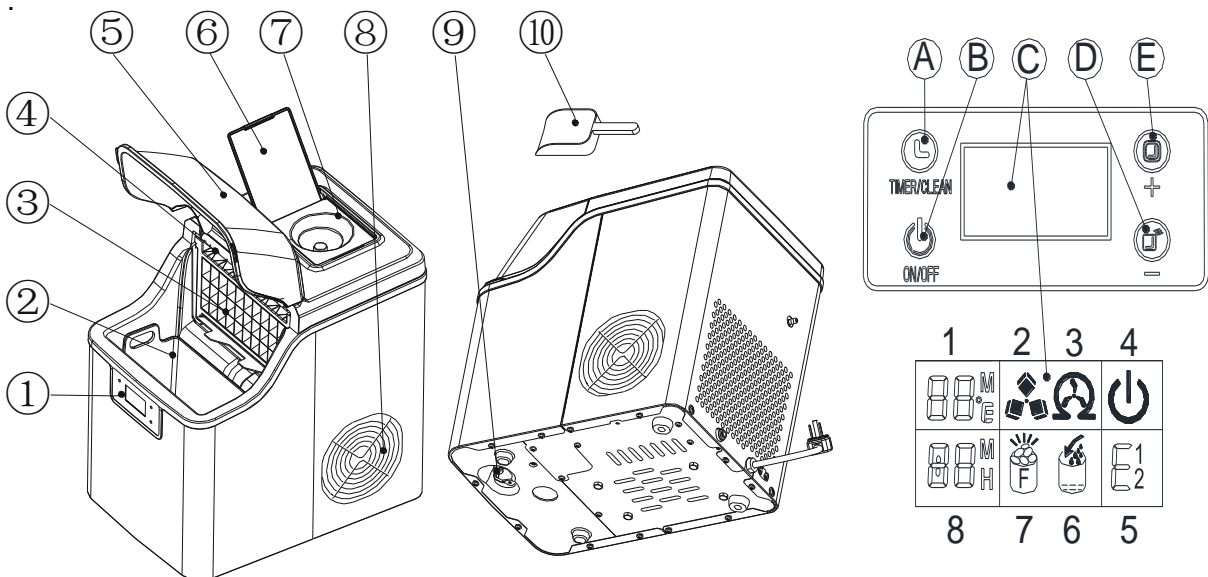

OPERATING PROCEDURES & MAINTENANCE

UNPACKING YOUR ICE MAKER

1. Remove the exterior and interior packaging. Check that ice basket and ice scoop is included. If any parts are missing, please contact our customer service.
2. Clean the interior with lukewarm water and a soft cloth. Take out the ice basket and clean it
3. Find a location for your ice maker that is protected from direct sunlight and other sources of heat (i.e.: stove, furnace, radiator). Place the ice maker on a level surface. Make sure that there is at least 6 inches of space between the back and sides of your ice maker and the wall.
4. Allow one hour for the refrigerant fluid to settle before plugging ice maker in.
5. The appliance must be positioned so that the plug is accessible.

WARNING: fill with potable water only.

CONNECTING YOUR ICE MAKER



DANGER

*** Improper use of the grounded plug can result in the risk of electrical shock. If the power cord is damaged please call our customer service.**

1. This unit should be properly grounded for your safety. The power cord of this appliance is equipped with a three-prong plug which mates with standard three prong wall outlets to minimize the possibility of electric shock.
2. Plug your appliance into an exclusive, properly installed, grounded wall outlet. Do not under any circumstances, cut or remove the third (ground) prong from the power cord. Any questions concerning power and/or grounding should be directed toward a certified electrician.
3. This appliance requires a standard 220-240volt, 50Hz electrical outlet with three-prong ground.

CLEANING AND MAINTAINING YOUR ICE MAKER

Before using your ice maker, it is strongly recommended to clean it thoroughly.

1. Take out the ice basket.
2. Clean the interior with diluted detergent, warm water and a soft cloth.
3. Then use the water to rinse the inside parts, and drain out the water from the draining port by unplugging the Water drainage cap on the bottom.
4. The outside of the ice maker should be cleaned regularly with a mild detergent solution and warm water.
5. Dry the interior and exterior with a soft cloth.
6. When the machine is not in use for a long time, open the water drain cap to drain water completely out from the water reservoir.

After using your ice maker for a long time, we also suggest you should clean your unit. Especially to the water separator pipe and the water filters, you must clean them periodically.

1. If the water separator pipe is blocked and there is no water flowing down when you listen the compressor and the water pump inside are still working, please turn off the unit first and disassemble this pipe down, and clean it. Clean each hole on the pipe wall displayed in following picture. After cleaning, install back the water separator pipe and be sure the right terminal of the pipe connects to the silicone pipe well and as original.

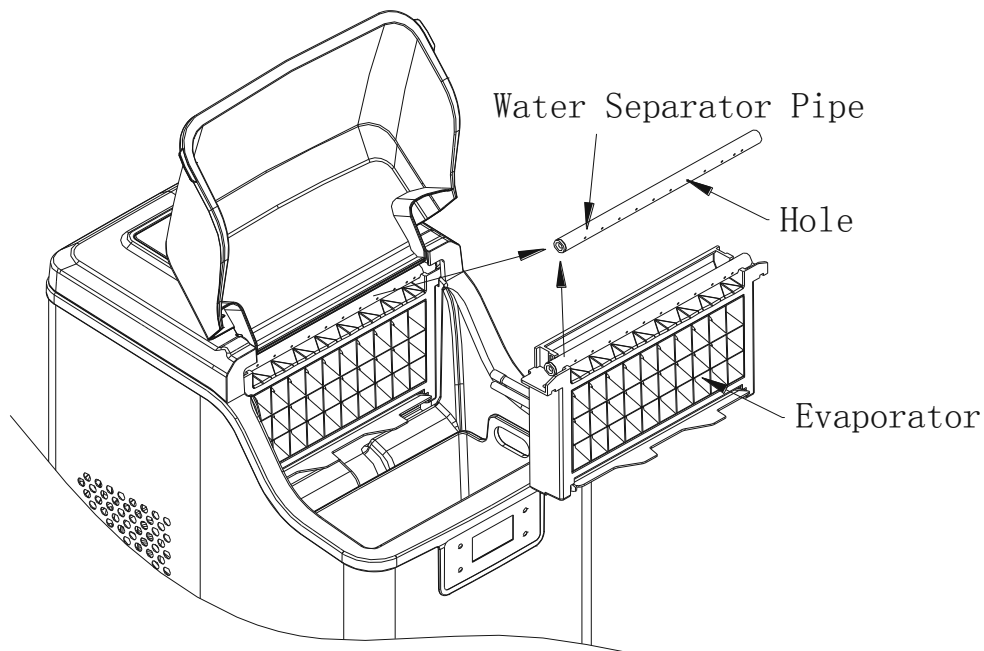

2. For both of the water tank and the big water reservoir, clean them with diluted detergent, warm water and a soft cloth. Then use the water to rinse the inside, and drain out the water from the draining port by unplugging the Water drainage cap on the bottom. It will help you keep the unit and ice-cube hygienically, and also make the unit work normally.
3. When cleaning, if find that the ice cube left on the evaporator and can not be taken out easily, you can turn on the unit to let the unit enter the ice making process, then press "ON/OFF" button for more than 5 seconds to let the unit start ice harvest process to melt the ice cube. It will help you remove the hard ice cube.

How to drain out the water from the internal tank and big water reservoir completely

Because the water in the big water reservoir is stop to drain port by the water valve, if you want to drain away all the water, please plug on the unit and but don't start the unit, then remove the drain port cap at the back. Wait some minutes, all of the water will flow out.

USING YOUR ICE MAKER



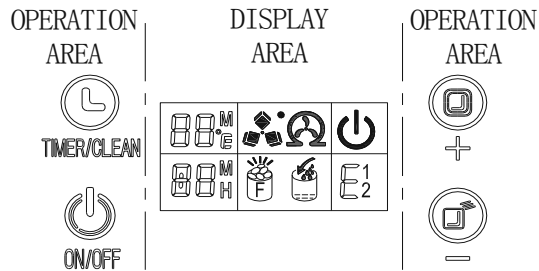

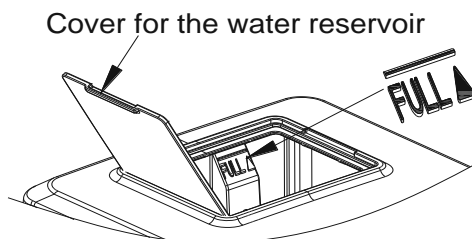

Operation panel and display area



1. Remove the cover of the water reservoir and pour potable water into water reservoir. And be sure to keep water level below the max. level with **FULL** mark displayed in following picture.



Warning: Do not pour the water into the internal water tank located underneath the ice basket. This tank is not big enough and will effect the ice making performance.

2. How to turn on the unit: Plug the unit, electric power symbol <  > will start to flash, and the present ambient temperature will display at top left corner of the displaying window, for example, "80F" letter means the 80 Fahrenheit ambient. Again press the "ON/OFF" button to start the unit, first the water will flow into the water tank to the standard water level, then the compressor start to run to make ice-cube, at same time, power symbol <  > will change to display always and ice-cube symbol <  > will be rotating state, the ambient temperature display will disappear. After some minutes of ice-making duration, the flashing digit will display in the ambient temperature displaying area, for example, the flashing digit "10M" means that it will take 10 minutes to complete this time ice-making process.
3. When ice maker harvest, symbol <  > flash, the water will flow from top water reservoir to bottom water tank through solenoid valve, the symbol <  > will be on, when the water in the bottom water tank is full, the symbol <  > will be off, then the next ice making cycle start again. When there is no water in the water reservoir, the symbol <  > will keep on. Turn off the unit and fill water again, then restart the unit to make ice cube. Or fill water directly and wait 20mins, the unit will restart.

Remark: The ice making cycle lasts about 13 to 25 minutes, depending on the ambient temperature. And for the first time, according to the initial water temperature, ice-making last time will be a little longer. In the extreme hot room temperature, ice-making time may be Vary a lot, but it will not exceed 35 minutes.

If you think the ice cube is not thick enough, during ice making, press the <+> and <-> to set the ice making lead time. Press one time and the ice making cycle will increase or Reduce one min, 6min most. This can only start from the new cycle.

4. When Ice Full symbol  is on, the unit will stop, take out the ice cube inside, the unit will start working again.

If press the button <ON/OFF> more than 5s, when the ice maker is working, the unit will start harvest. Press button <ON/OFF>, the unit will turn off.

Timer setting. Unit on timer setting, When the unit is working, timer setting the unit off.

Timer setting, When the unit is off, timer the unit on.

Press the <TIMER> button, the display will show <1H>, and then press <+> and <-> to set the time. During the setting, the H is flash, after 5s, the H will keep on and unit will in your Timer setting.

5. Water Drain: take off the Water draining cap the bottom of unit, then drain the water inside. It is better that exchange water every 24hours. and clean unit every 3days.

Automatic self-cleaning program

Start the self-cleaning program: Plug on the unit, press “TIMER/CLEAN” button on control panel for more than 5 seconds, to enter the self-Cleaning program need 20minutes. the symbol



rotate on display screens, time count down area display 20M.

Cancel the self-cleaning program: It takes about 20 minutes to complete one self-cleaning program. When the program is over, the system will be in off-state automatically. You can also press the “ON/OFF” button on control panel to cancel the self-cleaning program by force.

Warning

A、 make sure the water tank ,water filter and the water separator pipe is not blocked, clean them



B、 The water temp will affect the ice making capacity. The lower temp, the more ice cube produce.

C、 The cooler ambient temp, the more ice cube produce.

D、 always use good quality water to make sure the pump work well. Bad quality water will cause pump noise, but doesn't effect the unit working.

E、 The compressor restart 3mins later if you turn off the unit.

TROUBLESHOOTING

PROBLEM	POSSIBLE CAUSE	SOLUTION
 < > is on	Lack of water	Turn off the unit and add water to <FULL>level, then re-start the unit.
 < > is on	Too much ice cube in the basket	Remove the ice cube in the basket
The water reservoir has water, but  < > is on	The inlet solenoid valve breakdown	Need the technical service person to maintain
<E1> is on	Ambient temp sensor breakdown	The unit can still work, change a new sensor
<E2> is on	Water temp sensor breakdown	The unit can still work, change a new sensor
No water in the water Separator pipe	The holes are blocked	Use slim wire to prick each hole, till The water can flow out easily.
	Water filter block	Clean the water filter
Ice cube thick and can' t Drop down	Ice making cycle too long	Press <->to reduce the ice making time.
Ice cube thin	Ambient temp too high	Move the unit to cool place
	Water temp too high	The water temp should be no more morethan25°C (77°F) .
	Ice making short	Press<+>to increase the ice making Time.
Unit work but no ice cube	Ambient temp is high or the Water temp is high	Move the unit to somewhere ambient Temp lower than30°C(86°F),fill cool water.
	Refrigerant system leakage	Need the technical service person to maintain
	Refrigerant system block	Need the technical service person to maintain

TECHNICAL PARAMETERS & CIRCUIT DIAGRAM

TECHNICAL PARAMETERS

Model	HEF955
Protection Type	I
Climate Type	SN/N/ST/T
Power	220-240V/50Hz
Ice Making Current	1.1A
Ice Harvest Current	1.3A
Refrigerant	R290/32g
Net Weight	9.5Kg
Vesicant	C ₅ H ₁₀
Enclosure	Stainless

- Arctica Ice Maker is supplied with a 3 pin plug and lead with a 13 amp fuse
- Appliance must be earthed
- If in doubt contact a qualified electrician or your Arctica distributor

Disposal



Under WEEE regulations this product must not be disposed of as household waste. To prevent damage to the environment and humans this product must be disposed of in an approved and environmentally friendly recycling process. For more information on how to dispose of this correctly please contact your Arctica distributor or local authority responsible for waste disposal.

Compliance



All Arctica parts and products have under gone a stringent testing process to ensure that comply with the provisions of the relevant specific standards and all UK legislations.

Meanwhile, they also comply with all European standards and specifications.

All Arctica products carry the UKCA and CE approval symbols.