



Wet Bain Marie
NPWB2/NPWB4/NPWB6



British Built for Purpose.





Welcome to Parry

Parry is one of the UK's foremost manufacturers of high-quality Stainless Steel Fabricated Products with a 40-year heritage rooted in British craftsmanship.

At Parry, quality and service are second nature. Striving to exceed our customers' expectations is not just our motto; it's the very heartbeat of our business. Our commitment to our customers is reflected in the **Parry 4E Standard Inspection Body** stating that all our products are:



Easy to use



Easy to maintain



Easy to clean



Easy to repair

Our ranges of Stainless Steel Products have been specifically designed with the consumer in mind and are tailored and compliant to your specific industry sector. All our products are 4E Compliant and meet EU & UK regulations, where applicable. The Parry brand stands for quality, reliability and value.

Our British designed products have been created by our expert in-house development team and manufactured to exacting standards using Industry specified grade of European stainless steel and holding relevant EU & UK certification for all product.

ISO9001 certification and continual investment in the training and development of our highly skilled, artisan workforce means that our clients have genuine peace of mind that they are buying hand crafted, quality products supported by five-star customer service. All Parry products meet EU regulations for their respective sector.

We are LEAN manufacturers, minimising waste, maximising productivity. We are proud to run an operation that is committed to minimising our impact on the environment.

Our equipment and furniture are manufactured in our 45,000 sq ft manufacturing facility in Draycott, Derbyshire in England's industrial heartland. Products are made to order if not available in our stocked items which means you can choose from 600 products, offering over 3,500 variants, with short lead times to suit your specific needs. That means you get exactly what you need when you need it.

Our product information can be found here, in our brochure or on our website www.parry.co.uk.

You have my personal commitment that Parry will exceed your expectations. Should you have any questions please contact your distributor. Alternatively, our customer services team will be happy to help you on **01332 875544**.

Mark Banton MBA
Managing Director



Contents

Contents.....	1
Product Overview	2-3
Safety Instructions	3
Technical Data	4
Installation Instructions	4
Operating Instructions	5
Cleaning Instructions	6
Maintenance Instructions.....	7
Fault Finding	8
Service Information.....	9
Wiring Diagram	10
Exploded View.....	11
Parts List	12-13
Warranty Information.....	14
Disposal & Recycling	15

Parry Catering Equipment (Midlands) Ltd, Town End Road, Draycott, Derby, DE72 3PT.
Sales Tel: 01332 875544



Product Overview

NPWB2

Excellent for keeping foods at ready-to-serve temperatures, the Parry NPWB2 electric wet bain marie is ideal for mobile caterers, restaurants, cafes and pubs. Made from high grade stainless steel and featuring a front mounted easy-drain valve, the unit is user friendly and effortless to clean. Temperature is regulated by the simple responsive thermostat control dial, and the unit is supplied with stainless steel pots and lids as standard.





NPWB4

Made from high grade stainless steel, this Parry bain marie comes with four circular pots, ideal for keeping pre-cooked food at hygienic, ready to-serve temperatures. Perfect for buffets and self-service environments, the bain marie can also be used for the preparation of sauces and custards and has a front manual dial for easy temperature control.

NPWB6

With its 6 x 4 litre pot capacity, the Parry NPWB6 electric wet bain marie is a versatile addition to any commercial catering establishment. Ideal for storing pre-cooked foods – curry, gravy, chilli and stew, for example – at safe and hygienic temperatures, the bain marie is designed to fit comfortably on commercial countertops. Constructed from high quality stainless steel, the front-mounted drain valve ensures easy cleaning.

These units lead the industry in:

-  Design and aesthetic appeal
-  Performance
-  Power
-  Functionality
-  After sales support



Product Overview

Features	NPWB2	NPWB4	NPWB6
Unpacked weight (kg)	14	20	25
Packed Weight (kg)	17	25	45
Dimensions (w x d x h) mm	300 x 600 x 360	450 x 600 x 360	750 x 600 x 360
Pot capacity	2 x 4 litre	4 x 4 litre	6 x 4 litre
Cooking zones	2	4	6
Wet or dry	Wet	Wet	Wet
Plug	Yes	Yes	Yes
Power rating	3kW	3kW	3kW
Warranty	2 years	2 years	2 years



Safety Instructions

**IMPORTANT, PLEASE READ INSTRUCTIONS FULLY BEFORE USE.
ENSURE THE APPLIANCE IS ISOLATED FROM THE POWER SUPPLY BEFORE INSTALLING,
CLEANING OR MAINTAINING.**

This appliance has been designed to keep food warm and therefore during its use parts of the appliance will become very hot. All personnel must be given sufficient supervision and training in the safe use of this appliance.

ALL APPLIANCES OTHER THAN THOSE FITTED WITH A SEALED MOULDED PLUG MUST BE FITTED BY A QUALIFIED ELECTRICIAN, IN ACCORDANCE WITH CURRENT REGULATIONS.

The unit should be installed in compliance with the INSTALLATION INSTRUCTIONS and the NATIONAL REGULATIONS in force at the time. Particular attention should be paid to the Health and Safety at Work Act.

To prevent shocks, all appliances whether gas or electric, must be earthed.

To avoid scratching the highly polished exterior surface of this equipment whilst in transit, the protective film on the exterior surfaces has NOT been removed.

It is IMPORTANT that this protective film is peeled off before the equipment is used.



Technical Data

	NPWB2	NPWB4	NPWB6
Nominal Voltage	240 v ~ 50 hz	240 v ~ 50 hz	240 v ~ 50 hz
Nominal Current	12.5 Amps	12.5 Amps	12.5 Amps
Nominal Wattage	3000 W	3000 W	3000 W
Dimensions (mm)	300 x 600 x 310	450 x 600 x 310	750 x 600 x 310
Weight (kg)	14	20	25



Installation Instructions

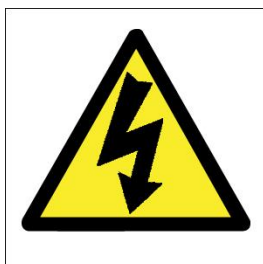







ELECTRICAL INSTALLATION

ALL APPLIANCES OTHER THAN THOSE FITTED WITH A SEALED MOULDED PLUG MUST BE FITTED BY A QUALIFIED ELECTRICIAN, IN ACCORDANCE WITH CURRENT REGULATIONS.







Operating Instructions

DO NOT USE THESE MACHINES FOR COOKING PURPOSES

-  Ensure the drain tap is in the closed position where fitted
-  Fill the tank with water until it reaches just below the bottom of the pots
-  Turn on the power supply, the red lamp will illuminate to indicate the power is on
-  Turn the thermostat dial to the required setting, the green lamp will show indicating that there is power to the element.
-  When the desired temperature is reached the green lamp will extinguish, this procedure will be repeated automatically as the thermostat maintains a constant temperature.
-  Fill the containers with hot food and replace the covers.
-  The water content inside the tank must be monitored and topped up as required, never let the water drop below the level of the element.

WATER CHANGING ON MACHINES FITTED WITH A DRAIN









ALWAYS SWITCH OFF THE MACHINE AND ISOLATE FROM THE MAINS SUPPLY BEFORE CHANGING THE WATER.

-  Unscrew the bung fitted to the drain tap and connect the drain spout provided.
-  Place a suitable receptacle underneath the spout
-  Lift the locking device and slide the drain tap across
-  After draining slide the tap back across and replace the bung



Cleaning Instructions

The appliance should be cleaned after every use.

-  Allow unit to cool down before cleaning
-  Turn off unit at the mains power.
-  Remove containers and clean in hot soapy water
-  With the containers removed wipe down the machine with a soft cloth, do not use abrasive materials.
-  Clean the tank on a regular basis to avoid scale build up, which could reduce the life of the element.
-  If scale has built up, use a suitable descaling fluid or powder, and follow product instructions.
-  Stainless steel cleaners maybe used and cleaning instructions on the product must be adhered to.
-  Never clean the unit with water jets.



Maintenance Instructions

Ensure the appliance is isolated from the power supply before installing, cleaning or maintaining the appliance.

Maintenance and service must only be undertaken by a qualified electrician.



Parry Catering provides a complete after-sales service by offering the sales of spare parts directly to customers. Buying spares straight from the manufacturer allows customer to experience exceptional value and speedy delivery on all spare parts.

For more information on buying spares visit:

www.parry.co.uk/parry-commercial-catering-spares



Fault Finding

Fault	Check	Solution
Mains lamp does not illuminate	<ol style="list-style-type: none">1. Check the unit is plugged into the mains supply and the socket is switched on.2. Check the fuse in the plug3. Try a different socket4. If the unit has been permanently connected to a fused switch, ask a qualified electrician or competent person to check the connections.	If the problem continues please contact your distributor



Service Information

This appliance should be routinely serviced to prolong its lifetime. Parry recommends that the appliance is serviced every 12 months by a Parry authorised engineer. Failure to service your product within the initial 12 month warranty period will cause the 24 month warranty to become void.

If the supply cord becomes damaged, it must be replaced by the manufacturer, it's service agent, or a similarly qualified person.

Enhanced 2 Years Warranty

Parry Catering (Midlands) Ltd offer an enhanced warranty of two years (including parts and labour) on all of the Parry manufactured products. To take advantage of this you should register your warranty by logging onto the company website and filling out our simple form.

www.parry.co.uk/the-parry-warranty

If you have any issues with your product and wish to request a warranty call you can contact our friendly team who will organize a Parry approved service engineer to attend and fix your problem.

All warranty requests can be sent to warranty@parry.co.uk alternatively call our warranty department for technical assistance on **01332 875544**





Wiring Diagram

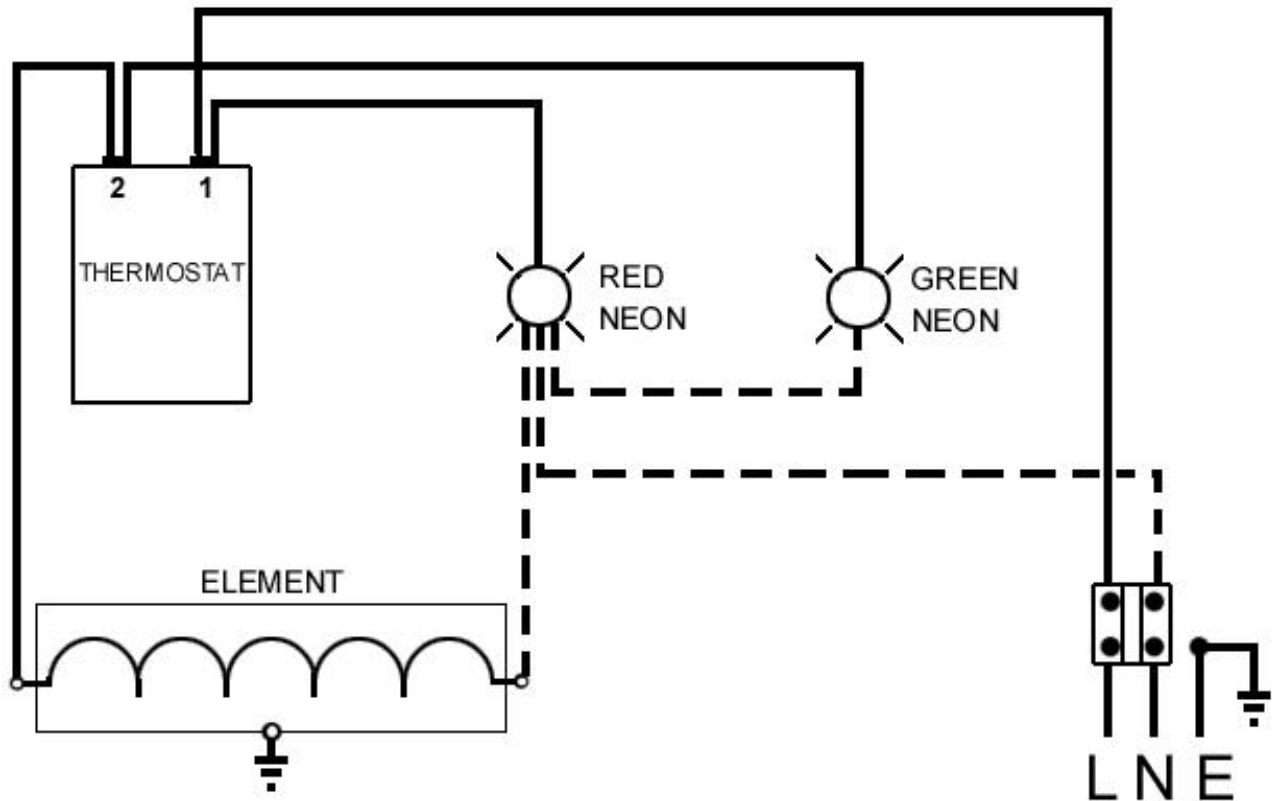



Exploded View

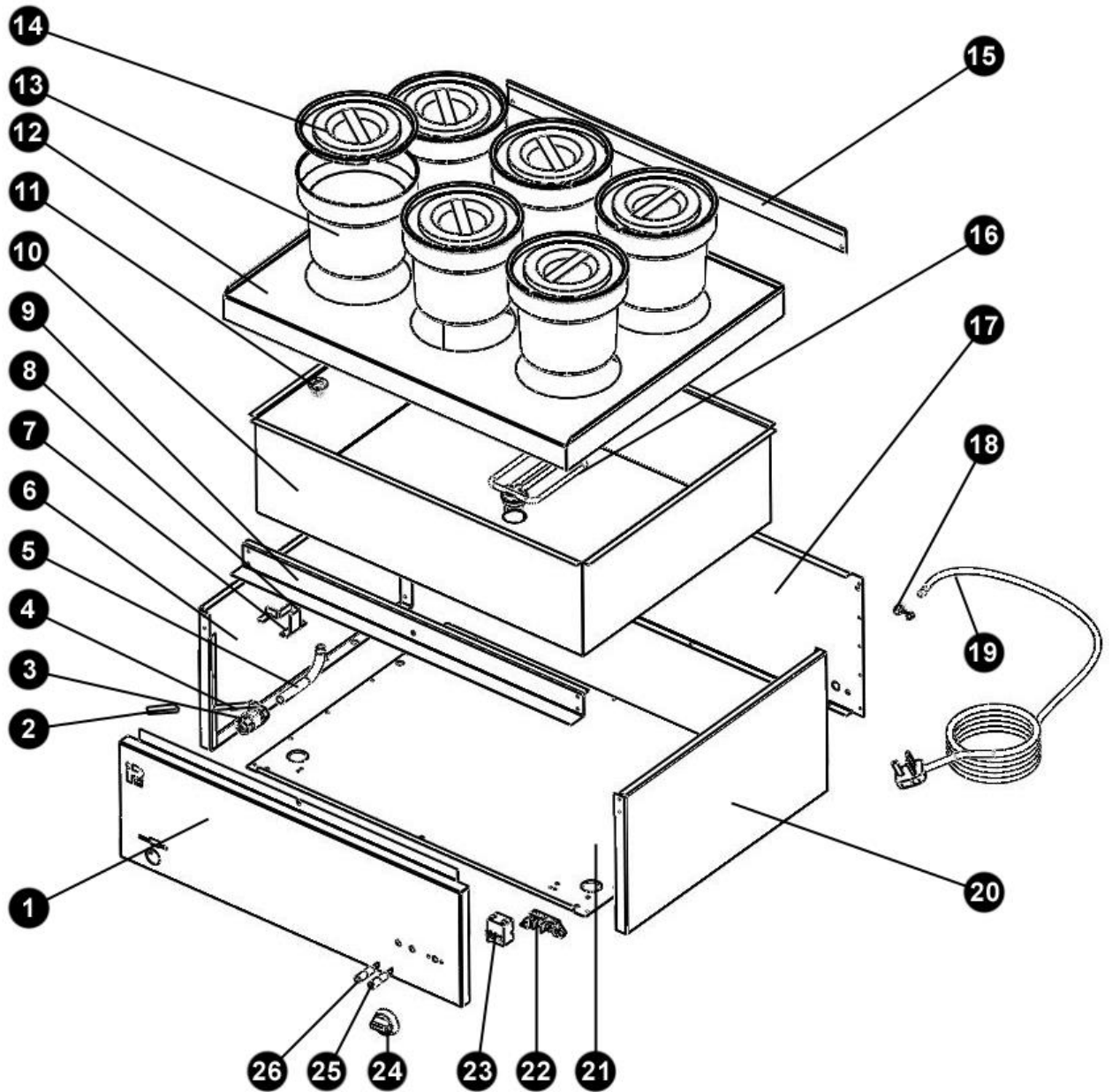



Parts List

Part Number	Description	NPWB2	NPWB4	NPWB6
1	*Fascia			
2	Tap Sleeve	HANDLESLEEVE	HANDLESLEEVE	HANDLESLEEVE
3	Ball Valve	VALVELB12	VALVELB12	VALVELB12
3a	15mm Olive	OLIVE0015	OLIVE0015	OLIVE0015
3b	Brass Bush	NUTMBSP12	NUTMBSP12	NUTMBSP12
4	Tap Handle	LCPTAPHANDL	LCPTAPHANDL	LCPTAPHANDL
5	Drain Tube	TUBEBEND4	TUBEBEND4	TUBEBEND4
6	*LH Side Panel			
7	*Tap Latch			
8	*Tap Latch Bracket			
9	*Front Support			
10	*Tank			
11	Bowl Insert	BOWLINSSS	BOWLINSSS	BOWLINSSS
11a	Washer	WASS14022	WASS14022	WASS14022
11b	Nut	NUT4BOWLSSS	NUT4BOWLSSS	NUT4BOWLSSS
11c	15mm Olive	PLUGBSP12	PLUGBSP12	PLUGBSP12
11d	Brass Nut	PLUGBSP12	PLUGBSP12	PLUGBSP12
12	*Top			
13	Pot	BAMA00018	BAMA00018	BAMA00018
14	Pot Lid	"	"	"
15	*Back Hook			
16	Element	ELBW03000	ELBW03000	ELBW03000
17	*Back Panel			
18	Strain Relief Bush	BUSR06003	BUSR06003	BUSR06003
19	Mains Lead	MLEAD25	MLEAD25	MLEAD25
20	*RH Side Panel			
21	*Base			



Parts List

22	Terminal Block	TB3POLETT	TB3POLETT	TB3POLETT
23	Thermostat	TMST5513015	TMST5513015	TMST5513015
24	Control Knob	KNOBPHEN	KNOBPHEN	KNOBPHEN
25	Red Neon	LNRE2211P	LNRE2211P	LNRE2211P
26	Green Neon	LNGN2211P	LNGN2211P	LNGN2211P
	Rubber Feet	RUBBRFOOT	RUBBRFOOT	RUBBRFOOT
	Drain Spout comprising of: -	COPPBEND01 OLIVE0015 NUTMBSP12	COPPBEND01 OLIVE0015 NUTMBSP12	COPPBEND01 OLIVE0015 NUTMBSP12
	Blanking Plug	PLUGBSP12	PLUGBSP12	PLUGBSP12

*Metalwork Components



Warranty Information

The manufacturer's warranty is only valid in the UK mainland. Northern Ireland, Western Isles, Inner Hebrides and Islands are parts only warranty. Please be aware that the warranty starts from the date of purchase from Parry and not the sale or installation date of the equipment.

To be eligible for a 2 year warranty, products must be serviced at least once within the first 12 months of purchase.

All service calls will be carried out between 8am and 5pm, Monday to Friday.

Your warranty is invalid if your equipment has not been installed in accordance with the manufacturer's instructions. The misuse, alteration or unauthorised repairs of the equipment will also invalidate the warranty.

During the warranty period it is at Parry's discretion whether to repair or replace the equipment.

The warranty only applies if the equipment has been used in a professional manner following the manufacturer's instructions and maintenance guidelines.

The warranty covers defects in the material and component failure only. We are not liable for trading loss, loss of perishable items, water damage or loss due to injury or fire damage.

Please ensure you have referred to the manufacturer's instruction before placing a warranty call.

Contact our warranty department on **01332 875544** for technical assistance.











Please have your model number ready before calling.

All warranty requests must be submitted to warranty@parry.co.uk.

Failure to pay any warranty charges will result in your warranty being put on hold until the bill has been settled. Any issues regarding the raised charges should be put in writing to our warranty department for further investigation.

Register your product by visiting our website www.parry.co.uk

Not covered under warranty

-  Fault due to incorrect installation, poor maintenance or equipment abuse.
-  Resetting of equipment or circuit breakers.
-  Faulty electrics – e.g. customer's plug socket, plug, wiring, junction box fault, wrong fuse.
-  Products must be serviced within the first 12 months to be eligible for the 2 year warranty
-  Product not covered by warranty if combustible materials have been used, e.g. plastic trays.
-  Foil used on racks, blockages and lime scale issues.
-  Failure to grant access for pre-arranged service call.
-  Equipment that has been set up or used incorrectly e.g. dishwasher detergents, levelling and setting up of doors on a six burner cooker.
-  Excessive carbon build-up on griddle plates or overuse of lava rock on chargrills. (Recommended use by Parry no more than 2kg.)
-  All of the above points are not covered by warranty and any costs incurred, because of the above, will be forwarded to the parties responsible for placing the call.



Disposal & Recycling

This appliance is marked according to the European Directive 2002/96/EC on Waste Electrical and Electronic Equipment (WEEE).

By ensuring this product is disposed of correctly, you will help prevent potential negative consequences for the environment and human health which could otherwise be caused by inappropriate waste handling of this product.

A symbol on the product, or on the documents accompanying the product, indicates that

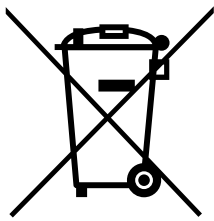

this appliance may not be treated as household waste. Instead it should be handed over to the applicable collection point for the recycling of electrical and electronic equipment.

Disposal must be carried out in accordance with local environmental regulations for waste disposal.





For more detailed information about treatment, recovery and recycling of this product, please contact your local city office, your household waste disposal service or the shop where you purchased the product.

Parry Catering recognises our obligations to the EU DIRECTIVE covering the waste disposal of electrical and electronic equipment (WEEE). Parry Catering are committed to this policy in order to help conserve the environment.

At the end of this unit's life you **MUST** dispose of it in an approved manner. You **MUST** not discard the unit or place it in the refuse bin.

You have several options:

-  Take the unit to an approved WEEE scheme company, there will be one in your area.
-  Take the unit to an approved waste disposal site; many sites are managed by your local authority.
-  Contact the units manufacturer, importer or their agent; the contact details will be on the unit.

There will probably be a charge for this service which will depend on the physical size and location of the unit. You will be given a collection price for a curb side collection based on commercial rates prevailing at the time.

It should be noted that the unit to be collected should be suitably packed and sealed to prevent dangerous gases and fluids from escaping. The condition of the unit must also be clean to comply with health and safety regulations.