

NAGB101



10 x 1/1 GN

Item



LCD 10" Touch Screen

One Touch

Automatically and with only a single touch, you can access the ideal and most efficient cooking for each dish, due to the exclusive present and widely tested methods, times and system. A wide range of cooking methods is already tested in the field by a highly qualified group of workers.



MULTILEVEL



JUST IN TIME



AUTOCLIMA



FAST-DRY



SMOKING



FLAVOURING



ECOVAPOR



TURBOVAPOR (*)



ECOSPEED



GFT
(only for gas models)



LCS CLEANING SYSTEM
COMBI CLEAN
CALFREE (*)



VIDEO RECIPES



CLOUD EVOLUTION



CHEF PORTAL



SYNCHRONISATION



REMOTE SERVICE

(*) only for models with boiler

COOKING MODES

- ICS (Interactive Cooking System), an automatic cooking system for Italian, French, International, Spanish, Russian, Asian and German recipes including their history, ingredients, procedure, automatic cooking program and plate presentation
- Manual cooking with three cooking modes: Convection from 30°C to 300°C, Steam from 30°C to 130°C, Combination Convection + Steam from 30°C to 300°C
- Programmable modes - Possibility to program and save cooking methods in an automatic sequence (up to 15 cycles) giving each program its own name, picture and information on the recipe

OPERATION

- DISPLAY that can be configured based on the needs of the user, bringing forward the programs used most
- LAINOX Cloud Wi-Fi/Ethernet connection system for saving personal settings, software updates, HACCP data archiving and downloading new recipes
- Automatic "one touch" cooking (ICS)
- Organization of recipes in folders with preview, giving each folder its own name
- Intelligent recognition of recipes in multilevel folders
- 10" colour screen (LCD - TFT) that is high definition and capacitive with "Touch Screen" functions
- SCROLLER PLUS knob with Scroll and Push function for confirming choices
- Automatic door opening using the "Open" button (optional)
- Instantaneous display in ICS cooking of the HACCP graphic

CLEANING AND MAINTENANCE

- Self-diagnosis before starting to use the equipment, with descriptive and audible signalling of any anomalies
- Automatic LCS (Liquid Clean System) with COMBICLEAN liquid cleanser and CALFREE liquid descaler, in 100 % recyclable cartridges
- CALOUT descaling liquid system that prevents formation and accumulation of limescale in the boiler, with separate container and automatic dispensing of CALFREE liquid descaling product
- Manual cleaning system with retractable hand shower

CONTROL EQUIPMENT

- Autoreverse (automatic reverse of fan rotation) for perfect cooking uniformity
- Automatic parallel compartment and core temperature control, DELTA T system
- Automatically regulated steam condensation
- Programmable deferred cooking
- Ability to choose up to 6 fan speeds; the first 3 speeds automatically activate the reduction in heating power
- For special cooking methods, you can use an intermittent speed
- Temperature control at the product core using probe with 4 detection points
- 2 core probe, a LAINOX exclusive
- Core probe connection through a connector outside of the cooking chamber, with the ability to quickly connect the needle probe for vacuum cooking and small pieces
- USB connection to download HACCP data, update software and load/unload cooking programs
- SERVICE program for: Inspecting the operation of the electronic board and display of the temperature probes - Appliance operation timer for all primary functions for programmed maintenance
- ECOSPEED - Based on the quantity and type of product, Naboo optimizes and controls the delivery of energy, maintains the correct cooking temperature, preventing any fluctuations (-10% energy / -30% water / -5% weight loss *)
- ECOVAPOR - With ECOVAPOR system there is a definite reduction in water and energy consumption due to the automatic controls of the steam saturation in the cooking chamber (-10% energy / -30% water / -10% steam *)
- TURBOVAPOR - With the TurboVapor system it automatically produces the ideal level of steam to cook "tough" products like egg pasta or asparagus, turnip greens and chard, which are notoriously fibrous vegetables
- GREEN FINE TUNING - A new burner modulation system and high efficiency exchanger to prevent power waste and reduce harmful emissions (-10% energy / -10% CO2 *)

CONSTRUCTION

- IPX5 protection against sprays of water
- Perfectly smooth, watertight chamber
- Door with double tempered glass with air chamber and interior heat-reflecting glass for less heat radiation towards the operator and greater efficiency
- Internal glass that folds to open for easy cleaning
- Handle with left or right hand opening
- Adjustable hinge for optimal seal
- Deflector that can be opened for easy fan compartment cleaning

GAS HEATING SYSTEM

- Blown air type of modulating burners for the cavity
- Automatic flame ignition
- Electronic control of the flame with automatic ignition reset
- High efficiency heat exchanger with steel AISI 310 S expansion cabinet

STEAM GENERATOR

- AISI 316 fully insulated steam generator
- Blown air type of modulating burners for the steam generator
- Automatic boiler pre-heating
- Daily automatic boiler draining (temperature of drained water below 60°C) and rinsing
- Alarm in case of boiler de-scaling required
- Boiler semi-automatic de-scaling program
- CAL-OUT system to prevent scale build-up within the boiler, as standard

SAFETY FEATURES

- Cooking compartment safety thermostat
- Cooking compartment safety device for pressure built-up and depression
- Fan motor thermic protection
- Flame detection sensor interrupting gas flow in case of switch of flame failure
- Safety pressure switch for lack of gas alarm
- Magnetic door switch
- Lack of water displayed alarm
- Self-diagnosis and fault display
- Component cooling system with overheat display control
- Two-stage gas valve
- Boiler safety thermostat
- Boiler water level probes
- Boiler probe to check boiler completely empty

STANDARD EQUIPMENT

- Automatic cleaning system LCS Liquid Clean System (equipped with 2 tanks of COMBICLEAN detergent, 4,5 kg. each)
- CALOUT descaling liquid system (equipped with 1 tank of anti-scale product CALFREE, 4,5 kg. each)
- Wi-Fi connection
- Multipoint core probe (Ø 3 mm)
- Built-in and retractable hand shower with tap
- 2 stainless steel grids 1/1 GN

NAGB101

OPTIONAL - TO BE REQUESTED WHEN ORDERING OVEN

- Automatic door opening - not compatible with handle (not available with right hinged door)
- Right hinged door
- Configuration for connection to extraction hood
- Flue with wind protection device (compulsory for all installations without extraction hood)
- Extra charge for removable rack + compulsoring frame
- Extra charge for pastry version removable rack 600 x 400 + compulsoring frame
- Extra charge for pastry version shelf racks 600 x 400
- SMOKEGRILL - 3 in 1 - Barbecue System / Smoking / Flavouring
- Extra charge for Ethernet connection

ACCESSORIES

- Multipoint core probe for large items. Pin length 180 mm. Ø 3 mm
- Needle core probe - Ø 1 mm.
- Multiprobes system - 2 multipoint core probes - Ø 3 mm.
- Fat filter
- USB pen to download HACCP data, update software and load/unload cooking programs
- Set of feet (h - 150 mm)
- Stainless steel heat shield for the unit right side panel (essential when the oven is positioned next to heat sources)
- Stainless steel floor stand
- Special floor stands for insertion of the blast chiller
- Side runners
- Stainless steel shelf
- Neutral cabinet with doors and side runners
- Neutral cabinet with door
- Static holding cabinet and slow cooking
- Flanged feet kit for floor stands, for marine installations
- Castor kit for floor stand, 2 with brake
- Trolley for removable oven racks with drip tray
- Removable rack (to be used with compulsoring frame)
- Compulsoring frame for removable oven rack and plate racks
- Pastry version - Removable rack 600 x 400 (to be used with compulsoring frame)
- Pastry version - Pair of shelf racks 600 x 400
- Plate racks (to be used with compulsoring frame)
- Rack thermal cover
- Extraction hood with air-cooled condenser (available only for prearranged ovens)

TECHNICAL DATA

Chamber capacity	GN	10 x 1/1	Total electric power	kW	1
Distance between layers	mm	70	Gas versions nominal heating output	kW / kcal	28 / 24080
Number of meals		80 / 150	Chamber heating output	kW / kcal	18 / 15480
External dimensions	mm	930 x 825 x 1040 h	Steam heating output	kW / kcal	18 / 15480
Dimensions with packing	mm	1040 x 980 x 1250 h	Fan power	kW	1
Weight - Net / Gross	kg	186 / 208	Power supply voltage	V - 50 Hz	AC 230

Special voltages and frequencies upon request

NAGB101

The data reported in this document is to be considered non-binding. The company reserves the right to make changes at any time, without prior notice.



Electric power supply cable inlet



Gas inlet and type of thread



Flue pipe



Boiler descaling cap

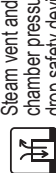

Steam vent and chamber pressure drop safety device



Oven steam vent



Air extraction



Normal water inlet



Softened water inlet



Liquid outlet



Steam trap

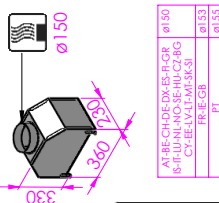
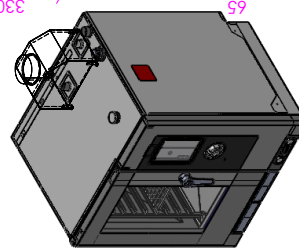
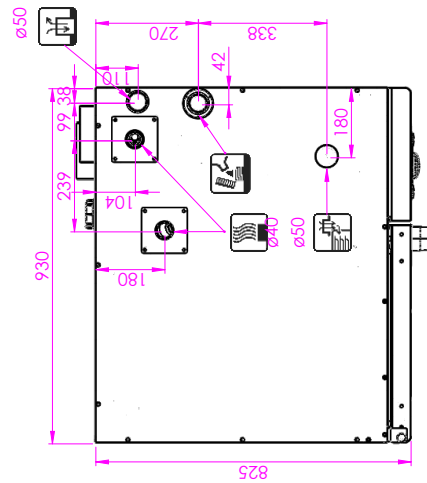
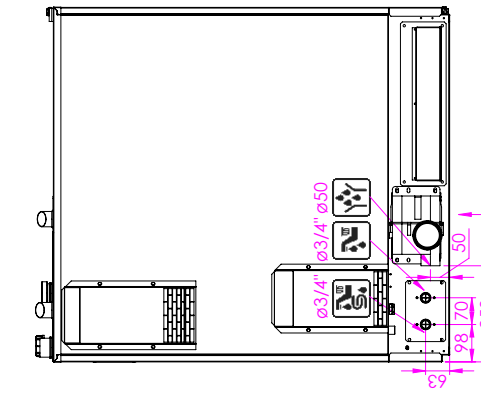
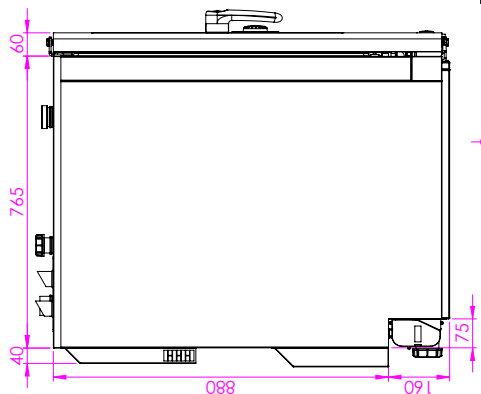
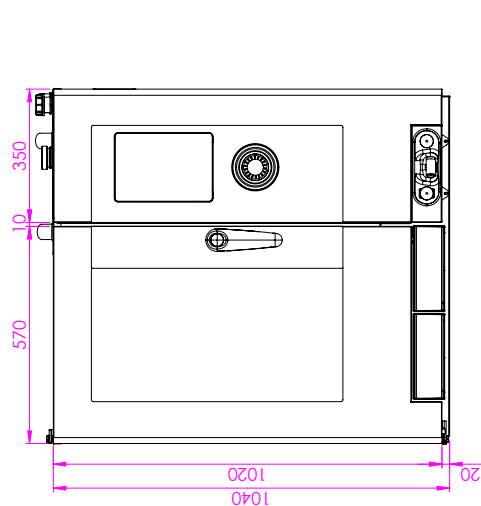

AI-BE-CH-DE-DX-BE-FI-GR	Ø150
SK-IL-NO-NL-PT-GB-SE	Ø150
CH-HU-CZ-RO-CY-PL-IR	Ø135
EL-ES-PT-GR	Ø135
FR-IE-GR	PT

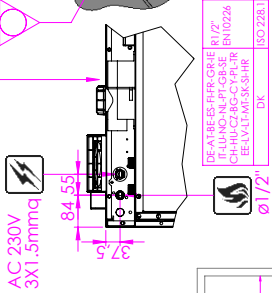

AC 230V
3X1.5mm²

FR-AT-BE-ES-IE-GR-IE	R1/2"
IT-LU-NO-NL-PT-GB-SE	Ø10/24
CH-HU-CZ-RO-CY-PL-IR	Ø10/24
EL-ES-PT-GR	ISO 228.1
DK	



According to CE rules, gas ovens must be installed where proper evacuation of burnt gas can be provided (type B13, B23, A3)

