

## Contact Us

Should you need to get in touch with us (UK and Northern Ireland only), please call the Customer Care Helpline on:

**0844 815 3747**

For customers outside the UK and Northern Ireland, please contact your local supplier.

### Your 1<sup>st</sup> Year Guarantee

To fulfil the conditions of your guarantee, this appliance must be correctly installed and operated, in accordance with these instructions, and only be used for normal domestic purposes.

Please note that the guarantee, and Service availability, only apply to the UK and Republic of Ireland.



Stoney Lane, Prescot, Merseyside, L35 2XW



**GLEN DIMPLEX**  
HOME APPLIANCES

# INSTRUCTION MANUAL BUILT-IN WINE COOLER

Model No.:GDHA 150.300&600SSWC

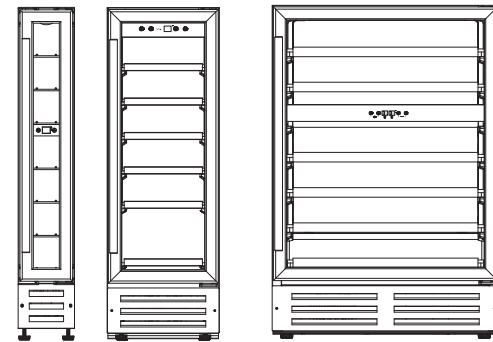

**BEFORE USE, PLEASE READ AND FOLLOW ALL SAFETY RULES AND OPERATING INSTRUCTIONS.**

## Important Safeguards

When using an electrical appliance, basic precautions should always be followed to reduce the risk of fire, electric shock, and injury to persons, including the following:

### For Your Safety

Read all instructions carefully, even if you are quite familiar with the appliance.

- The appliance is intended to be used exclusively for the storage of wine.
- Use this appliance only as described in this manual. Other uses not recommended may cause fire, electric shock or personal injury.
- This appliance is not intended for use by young children or infirm persons unless they have been adequately supervised by a responsible person to ensure that they can use the appliance safely.
- Young children should be supervised to ensure that they do not play with the appliance.
- To protect against the risk of electric shock, DO NOT IMMERSE the unit, cord, or plug in water or spray any other liquid.
- Unplug the appliance from the plug socket when not in use, when moving from one location to another and before cleaning.
- To disconnect the appliance, grip the plug and pull it from the wall outlet. Never pull by the cord.
- Do not operate the appliance in the presence of explosive and/or flammable fumes.
- Do not place the appliance or any of its part near an open flame, cooking or other heating appliance.
- Do not operate the appliance with a damage cord or plug, if the product malfunctions, or if it is dropped or damaged in any manner.
- The use of attachments not recommended by the manufacturer may be hazardous.
- Place the unit on a dry level surface.

- Do not operate if the housing is removed or damaged.
- A loose fit between the AC outlet (receptacle) and plug may cause overheating and a distortion of the plug. Contact a qualified electrician to replace loose or worn outlet.
- Locate the unit away from direct sunlight and sources of heat (stove, heater, radiator, etc.).
- This appliance is CFC- and HFC-free and contains small quantities of Isobutane (R600a), an environmentally friendly coolant.
- You must ensure that the cooling circuit is undamaged when installing the appliance. However, if it becomes damaged, avoid proximity to open fires and heat sources of all kinds. The room in which the appliance is located should be ventilated for a few minutes.
- Never use an appliance with a damaged circuit.
- Ensure that the ventilation openings to and from a built-in appliance are never blocked or covered. No liability will be accepted for any damage incurred owing to misuse of the appliance or as a result of repairs carried out by unqualified personnel. In this case neither the guarantee nor any other liability claims will apply.
- **WARNING:** Do not operate any electrical appliance inside the appliance.
- Do not attempt to repair or replace any part of your appliance unless it is specifically recommended in this manual. All other servicing should be referred to a qualified technician.
- Replace all panels before operating.
- Use two or more people to move and install the appliance. Failure to do so can result in back or other injury.
- Never clean appliance parts with flammable fluids. These fumes can create a fire hazard or explosion. And do not store or use gasoline or other flammable vapors and liquids in the vicinity of this or any other appliance. The fumes can create a fire hazard or explosion.

## Problems with Your Wine Cooler

You can solve many common Wine Cooler problems easily, saving you the cost of a possible service call. Try the suggestions below to see if you can solve the problem before calling customer service.

### Troubleshooting Guide

PROBLEM	POSSIBLE CAUSE
Wine Cooler does not operate.	Not plugged in. The appliance is turned off. The circuit breaker tripped or a blown fuse.
Wine Cooler is not cold enough.	Check the temperature control setting. External environment may require a higher setting. The door is opened too often. The door is not closed completely. The door gasket does not seal properly.
Turns on and off frequently.	The room temperature is hotter than normal. A large amount of contents has been added to the Wine Cooler. The door is open too often. The door is not closed completely. The temperature control is not set correctly. The door gasket does not seal properly.
The light does not work.	Not plugged in. The circuit breaker tripped or a blown fuse. The light switch is "OFF".
Vibrations.	Check to assure that the Wine Cooler is level.
The Wine Cooler seems to make too much noise.	The rattling noise may come from the flow of the refrigerant, which is normal. As each cycle ends, you may hear gurgling sounds caused by the flow of refrigerant in your Wine Cooler. Contraction and expansion of the inside walls may cause popping and crackling noises. The Wine Cooler is not level.
The door will not close properly.	The Wine Cooler is not level. The door was reversed and not properly installed. The gasket is dirty. The shelves are out of position.
Display "EL" or "EH".	The air temperature sensor is failed.

off the appliance and unplug. Clean and dry the interior thoroughly. To prevent odour and mold growth, leave the door open slightly: blocking it open if necessary.

### Moving Your Wine Cooler

- Remove all items.
- Securely tape down all loose items (shelves) inside your appliance.
- Turn the adjustable leg up to the base to avoid damage.
- Tape the door shut.
- Be sure the appliance stays secure in the upright position during transportation. Also protect outside of appliance with a blanket, or similar item.

### Energy Saving Tips

- The Wine Cooler should be located in the coolest area of the room, away from heat producing appliances, and out of the direct sunlight.
- Ensure that the unit is adequately ventilated. Never cover air vents.
- Only open the door for as long as necessary.

- Do not connect or disconnect the electric plug when your hands are wet.
- It is recommended that a separate circuit, serving only your appliance be provided. Use receptacles that cannot be turned off by a switch or pull chain.

**WARNING: To reduce the risk of fire, electric shock or personal injury, unplug or disconnect the appliance from the power supply before servicing.**

### Save These Instructions

If you are experiencing problems, check the Troubleshooting Guide at the back of this manual. It lists causes of minor operating problems that you can correct yourself.

### Disposal of Old Appliance

Dispose of your appliance packaging properly.

Refrigeration equipment must be properly disposed of in a way which protects the environment. This applies to your old appliance and to your new unit once it has reached the end of its service life.

**WARNING:** Please ensure that old, worn appliances are rendered unusable before disposal by removing the plug, cutting the network cable, and removing or destroying any snap fastenings or bolts. You will thus prevent children from locking themselves in the

appliance during play (risk of suffocation) or endangering their lives in any other way.

Disposal instructions:

- The appliance must not be disposed of in the dustbin or with normal household rubbish.
- The coolant circuit, particularly the heat exchanger at the back/bottom of the unit, must not be damaged.
- The  symbol on the product or its packaging indicates that this product is not to be handled as normal household waste but is to be taken to a recycling collection point for electrical and electronic goods. By correctly disposing of this product you are contributing to the protection of the environment and to the health of your fellow human beings. Improper disposal endangers health and the environment. Further information about the recycling of the product may be obtained from your town hall, refuse collection department or the store where you purchased the product.



## Features of Your Wine Cooler

For:150SSWC

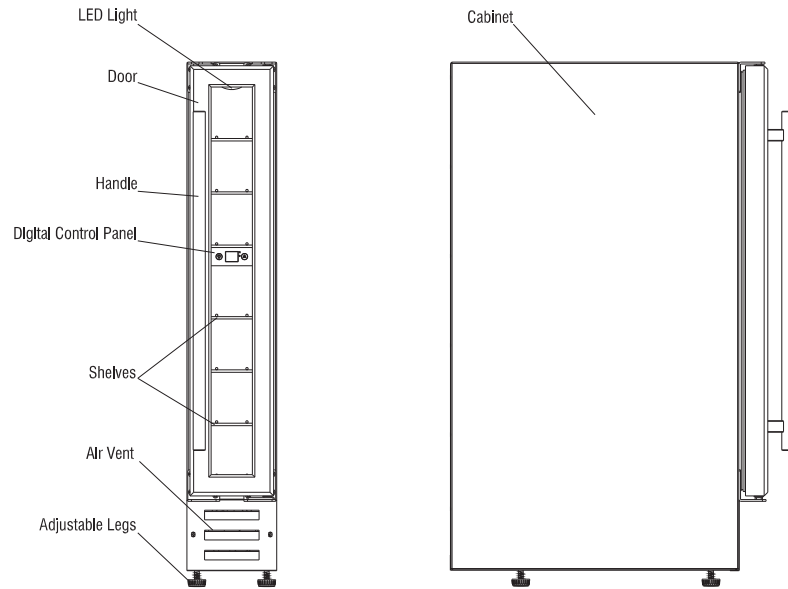

## Care and Maintenance

### Removing Shelves

- To remove any of the shelves from the rail compartment, move the shelf to the position where the notch of wooden shelf is exactly under the plastic post and lift the wooden shelf.
- In order to replace the shelf, repeat steps described above in reverse. And make sure to engage the shelves with the small pegs of the extended rails when the model is equipped with roller system.

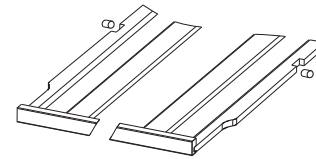

### Humidity Control (Optional)

- The wine cooler is equipped with a system for maintaining the correct level of humidity. Fill the small plastic reservoir (humidity box)  $\frac{3}{4}$  full with water, and fit onto the runners found on the top shelf of the wine cooler. Check the water level regularly and refill as necessary.
- Please ensure the reservoir is positioned correctly on the runners on the top shelf to avoid the possibility of water spillage.

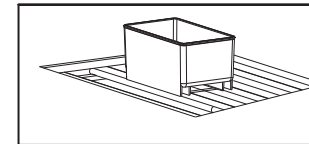

### Active Charcoal Filter (Optional)

Replace the active charcoal filter with new one once a year. It can be purchased from your dealer or from the Spare Parts Department.

- Turn the filter 90° clockwise or anti-clockwise.

And then remove the filter.

- Insert the new filter with the handle in the vertical position.
- Turn the filter 90° clockwise or anti-clockwise until they click into position.

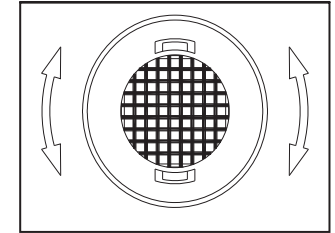

### Cleaning Your Wine Cooler

- Turn off the power, unplug the appliance, and remove all items including shelves and rack.
- Wash the inside surfaces with a warm water and baking soda solution. The solution should be about 2 tablespoons of baking soda to a pint of water.
- Wash the shelves with a mild detergent solution.
- Wring excess water out of the sponge or cloth when cleaning any area of the controls.
- Wash the outside cabinet with warm water and mild liquid detergent. Rinse well and wipe dry with a clean soft cloth.

### Power Failure

- Most power failures are corrected within a few hours and should not affect the temperature of your appliance if you minimize the number of times the door is opened. If the power is going to be off for a longer period of time, you need to take the proper steps to protect your contents.

### Vacation Time

- Short holidays:** Leave the Wine Cooler in operation for holidays of less than three weeks.
- Long absences:** If the appliance will not be used for several months, remove all items, turn

## Temperature Display

During normal operation, the temperature display on the control panel shows the temperature inside the appliance. **The temperature display will flash if**

- A different temperature is being set,
- The temperature in the zone deviates by more than 5°C from the set temperature. The temperature display flashing ensures that the temperature can not rise or fall un-noticed and impair the wine.

## Shelves

- To prevent damaging the door gasket, make sure the door is fully open when pulling shelves

out of the rail compartment.

- For easy access to the bottles stored, pull the shelves out approximately 1/3. The shelves are designed with an emergency stop to prevent them being removed too far when loaded.

## Defrosting

- The unit defrosts automatically.
- The evaporator behind the rear wall of the unit defrosts automatically. The condensate collects in the drainage channel behind the rear wall of the unit, and flows through the drainage hole into the drip tray above/by the compressor where it evaporates.

## Electrical Requirements

**Any electrical work required to install this appliance should be carried out by a qualified electrician or competent person. This appliance must be earthed. The manufacturer declines any liability should these safety measures not be observed.**

Before switching on, make sure the electricity supply voltage is the same as that indicated on the appliance data badge.

The appliance is supplied with a 13 amp plug fitted. In the event of having to change the fuse in the plug supplied, a 13 amp ASTA approved (BS 1362) fuse must be used. Should the plug need to be replaced for any reason. The wires in the mains lead are coloured in accordance with the following code:

**Green and Yellow: Earth**

**Blue: Neutral**

**Brown: Live**

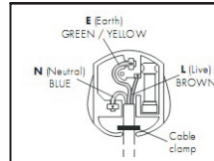

The wire coloured green and yellow must be connected to the terminal marked with the letter "E" or by the earth symbol  or coloured green and yellow. The wire coloured blue must be connected to the terminal "N". The wire coloured brown must be connected to the terminal "L".

Upon completion there must be no cut, or stray strands of wire present and the cord clamp must be secure over the outer sheath.

## For:300SSWC

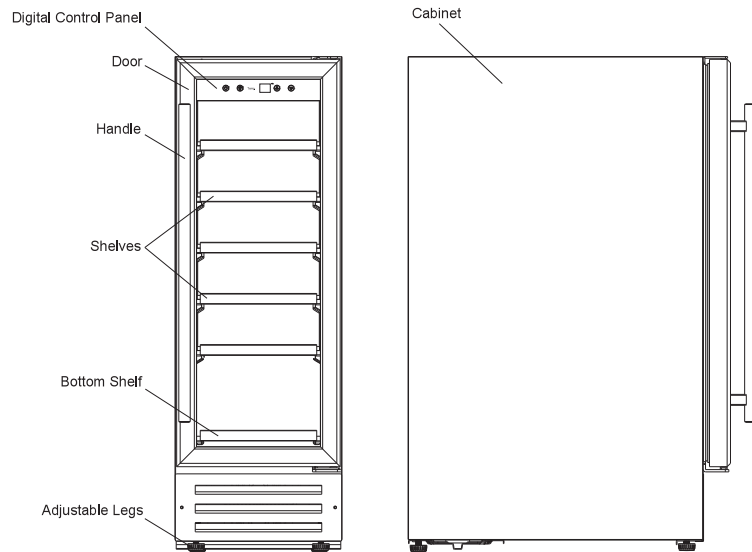

**For 600SSWC**

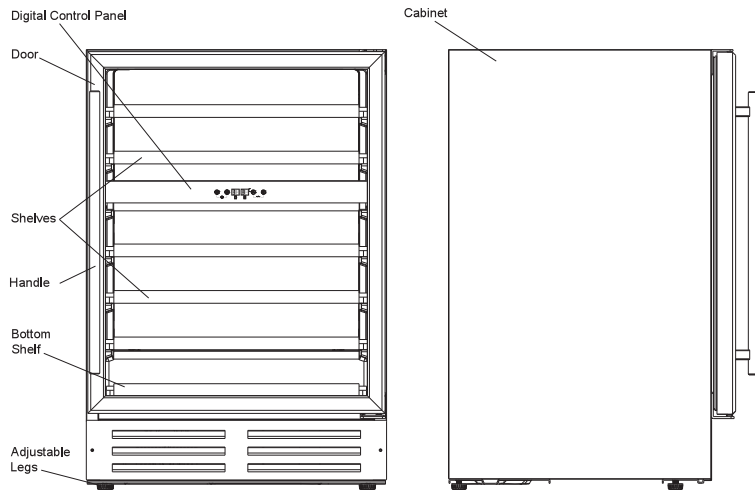

**USE AND CONTROL –  
600SSWC**

**The Controls of Your Wine Cellar**

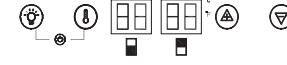

**POWER**

To control this appliance turn on/off. To turn OFF the appliance, touch the and marks at the same time for 5 seconds.

**SET**

To set or view the internal temperature setting for each zone.

**LIGHT**

To control the inner light turn on/off.

**UP**

Used to raise (warm) the set temperature by 1°C or 1°F.

**DOWN**

Used to lower (cool) the set temperature by 1°C or 1°F.

This icon indicates that the control panel is for the upper cooling zone

This icon indicates that the control panel is for the lower cooling zone

**°F/°C Selector**

To alter what temperature display is showing, press the light control button for 5 seconds.

**Setting the Temperature Control**

The wine cooler has two temperature zones. The temperature settings of LOWER ZONE and UPPER ZONE are adjustable with the range 5°-22°C/40°-72°F. It is recommended to set the LOWER ZONE to 13° ~ 18°C / 55 ~ 65°F which is ideal for storing white and red wines and the UPPER ZONE to 5° ~ 13°C / 40 ~ 55°F which is ideal for storing sparkling and white wines.

**NOTE: The temperature set for the LOWER**

**ZONE must always be the same or higher than that in the UPPER ZONE.**

**And in order to achieve the best performance, suggests that the temperature set for the LOWER ZONE is 4°C higher than at in the UPPER ZONE.**

- You can touch **SET** mark to set the internal temperature for each zone. The degrees indicators will appear in the display window marked for UPPER ZONE and for LOWER ZONE.
- When you touch the **SET** mark for the first time, the LED readouts will show the original temperature sets previously (the preset temperature at the factory for UPPER ZONE is 10°C / 50°F and for LOWER ZONE is 16°C / 60°F).
- Touch the **SET** mark once. The left LED indicator for UPPER ZONE will flash. Then touch the **UP** or **DOWN** marks to set the desired temperature.
- When you touch the **SET** mark again, the right LED indicator for LOWER ZONE will flash. Then proceed to touch the **UP** or **DOWN** marks to set the desired temperature for the LOWER ZONE.
- The temperature will increase 1°C or 1°F if you touch the **UP** mark once, or the temperature will decrease 1°C or 1°F if you touch the **DOWN** mark once.
- To view the "set" temperature in either zone at any time, touch the **UP** or **DOWN** mark, the "set" temperature will temporarily "flash" in the LED display for 5 seconds. You can touch the **SET** mark to view the temperature setting from one zone to the second zone.

## Operating Your Wine Cooler

The Wine Cooler should be placed in a position where the ambient temperature is between 16-35°C. If the ambient temperature is above or below this range, the performance of the unit may be affected. For example, placing your unit in extreme cold or hot conditions may cause interior temperatures to fluctuate. The range of 5-22°C may not be reached.

### Note:

- When you use the Wine Cooler for the first time or restart the Wine Cooler after having been shut off for a long time, there could be a few degrees variance between the temperature you select and the one indicated on the LED readout. This is normal and it is due to the length of the activation time. Once the Wine Cooler is running for a few hours everything will be back to normal.
- If the unit is unplugged, power lost, or turned off, you must wait 3 to 5 minutes before restarting the unit. If you attempt to restart before this time delay, the Wine Cooler will not start.

## USE AND CONTROL – 150/300SSWC

### The Controls of Your Wine Cellar



#### POWER

To control this appliance turn on/off. To turn OFF the appliance, touch the  mark and hold 5 seconds.

#### LIGHT

To control the inner light turn on/off.

#### UP

Used to raise (warm) the set temperature by 1°C.

#### DOWN

Used to lower (cool) the set temperature by 1°C.

### Setting the Temperature Control

- You can set the temperature as required by touching the **UP** or **DOWN** mark. When you touch the two marks for the first time, the LED readout will show the original temperature set previously (the temperature preset at the factory is 12°C).
- The temperature will increase 1°C if you touch the **UP** mark once, or the temperature will decrease 1°C if you touch the **DOWN** mark once.
- To view the "set" temperature at any time, touch the **UP** or **DOWN** mark, the "set" temperature will temporarily "flash" in the LED display for 5 seconds.
- The internal storage temperature will appear in blue color in the temperature display window.

### °F/°C Selector

- You can select whether the temperature display shows Celsius or Fahrenheit
- To alter what temperature display is showing, press the light control button  for 5 seconds.
- You cannot change the display if you are in process of adjusting the temperature of the wine cooler

## Installation Instructions

### Before Using Your Wine Cooler

- Remove all exterior and interior packing.
- Before connecting the Wine Cooler to the power source, let it stand upright for approximately 2 hours.
- This will reduce the possibility of a malfunction in the cooling system caused by handling during transportation.
- Clean the interior surface with lukewarm water using a soft cloth.
- The door on this appliance can be opened from either the left or the right side. The unit is delivered with the door opening on the left side. Should you wish to open the door from the right, follow the instructions 'Reversing the door swing of your appliance'.

### Installation of Your Wine Cooler

- The appliance is designed to be built in between kitchen cabinets and is supplied with adjustable feet that can be altered to fit various worktop heights. This wine cooler is fully compatible with any 600mm deep kitchen unit.
- Place your Wine Cooler on a floor that is strong enough to support it when it is fully loaded. To level your Wine Cooler, adjust the front leveling leg at the bottom of the Wine Cooler.
- Locate the Wine Cooler away from direct sunlight and sources of heat (stove, heater, radiator, etc.). Direct sunlight may affect the acrylic coating and heat sources may increase electrical consumption. Extreme cold ambient temperatures may also cause the unit not to perform properly.
- Avoid locating the unit in damp areas.

- Plug the Wine Cooler into an exclusive, easily accessible plug socket. Any questions concerning power and/or earthing should be directed towards a qualified electrician or an authorized products service centre.
- The air vent at the front of the appliance must never be covered or blocked in any way.
- The appliance must be installed to all electrical, plumbing, water and drain connections in accordance with state and local codes.

### Built-in Cabinet Instructions

This unit is designed for both built-in or free standing installation. If you plan to use this unit in a built-in application please follow the requirements shown to the below.

Cabinet Opening Dimensions (min)			
	150SSWC	300SSWC	600SSWC
Width	15 cm	30 cm	60 cm
Depth	60 cm	60 cm	60 cm
Height	87.5 cm	87.5 cm	87.5 cm

### Attention

- Store wine in sealed bottles.
- Do not overload the cabinet.
- Do not open the door unless necessary.
- Do not cover shelves with aluminum foil or any other shelf material which may prevent air circulation.
- Should the wine cooler be left empty for long periods it is suggested that the appliance is unplugged, and after careful cleaning, leave the door ajar to allow air to circulate inside the cabinet in order to avoid possible condensation, mold or odours forming.



## Installing the Handle

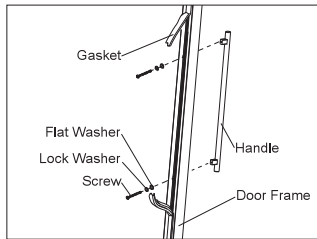

1. Remove the door gasket on the side you wish to install the handle - you can see two designated holes for handle installation.
2. Install the handle tightly as shown above with two screws, lock washers and flat washers provided.
3. Replace the door gasket.

## Electrical Connection

Check that the voltage marked on the product corresponds with your supply voltage.

**WARNING:** Improper use of the grounded plug can result in the risk of electrical shock. If the power cord is damaged, have it replaced by a qualified electrician or an authorized service center.

This appliance should be properly grounded for your safety. The power cord of this appliance is equipped with a three pins plug which mates with standard three pins wall outlets to minimize the possibility of electrical shock.

Do not under any circumstances cut or remove the third ground prong from the power cord supplied. For personal safety, this appliance must be properly grounded.

This appliance requires a standard 220-240 Volt AC ~50Hz electrical ground outlet with three pins. Have the wall outlet and circuit checked by a qualified electrician to make sure the outlet is properly grounded. When a standard 2 pins wall outlet is encountered, it is your responsibility and obligation to have it replaced with a properly grounded 3 pins wall outlet.

The cord should be secured behind the appliance and not left exposed or dangling to prevent accidental injury.

The appliance should always be plugged into its own individual electrical outlet which has a voltage rating that matches the rating label on the appliance. This provides the best performance and also prevent overloading house wiring circuits that could cause a fire hazard from overheated. Never unplug the appliance by pulling the power cord. Always grip the plug firmly and pull straight out from the receptacle. Repair or replace immediately all power cords that have become frayed or otherwise damaged. Do not use a cord that shows cracks or abrasion damage along its length or at either end. When moving the appliance, be careful not to damage the power cord.

Electrical fuse protection of at least 10 amperes must be provided. If the socket is no longer accessible once the appliance has been built-in, suitable measures must be taken during electrical installation to ensure that the appliance can be disconnected from the mains.

Do not use your appliance with an extension cord unless this cord has been checked and tested by a qualified technician or service person. The extension cord must be a VED-Listed, 3-wire grounding extension cord that has a grounding plug and outlet and that the electrical rating of the cord is 220-240 volts and at least 10 amperes.

## Reversing the Door Swing of Your Appliance

Should you desire to reverse the opening direction, please follow the instructions below.

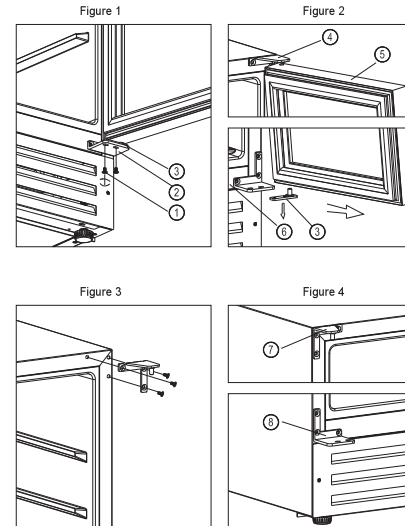

- |                       |                    |
|-----------------------|--------------------|
| ① Lock Screws         | ⑤ Door             |
| ② Right Lower Hinge   | ⑥ Cabinet          |
| ③ Door Shaft Assembly | ⑦ Left Top Hinge   |
| ④ Right Top Hinge     | ⑧ Left Lower Hinge |

**Note: All parts removed must be saved to do the reinstallation of door.**

1. Open the glass door and remove the two screws under the right bottom corner of the glass door that are used to hold the right lower hinge to the door shaft assembly. Be careful to support the glass door with hands to prevent it dropping after removing the screws. (Figure 1)
2. Pull down to remove the glass door and place it on a padded surface to prevent scratching it. (Figure 2)
3. Remove the right top hinge and right lower

hinge. (Figure 3). Remove the left top hinge and left lower hinge from the plastic bag that includes the instruction manual then install them at the designated positions at the left side of cabinet. (Figure 4)

4. Turn around the glass door 180° and reinstall it.