

BURCO

INSTRUCTION MANUAL

Autofill Wallmount Waterboilers

(Filtration & Non-Filtration models)

These instructions cover the following Burco models:
Burco Autofill Filtration: 5L – 069801, 10L – 069818
Burco Autofill (without Filter): 3L – 069924, 7.5L – 069931



Please read and
keep these
instructions

Burco is part of: Glen Dimplex Heating & Ventilation Millbrook House, Grange Drive, Hedge End, Southampton, SO30 2DF.	
Aftersales Tel: 0344 879 3470	
www.burco.co.uk	

Please keep these instructions in a safe place.

08/54071/0 (Jan 19)

Content	Page
About my product (please complete the details below)	2
Warning and Precautions	3-4
Introduction	5
Warranty Information	5
Accessories Kit	5
Technical Data	6
Installing Burco water boiler	6
Operating Instructions	9-12
Descaling & Cleaning advice and information	13-14
Changing Water Filter	14
Troubleshooting	15
Spare / Replacement Part information	15
Frequently asked questions (FAQ's)	16

About my product

Please take some time to complete the information below, it may save time if you need to contact us for any reason.

Model Number	0	6				
---------------------	----------	----------	--	--	--	--

Serial Number <small>(this can be found on the data badge on the back of the product)</small>	
---	--

Date of purchase	
Purchased from	

<p>In your instruction pack you will find a duplicate data badge which contains all the critical information above. You can peel off the backing and stick in the box below:</p>

Warnings and Precautions



WARNING. THIS SYMBOL MEANS THERE IS A RISK OF PERSONAL INJURY.



IMPORTANT. THIS SYMBOL MEANS THERE IS A RISK OF DAMAGING THE APPLIANCE.



THIS APPLIANCE MUST BE INSTALLED, COMMISSIONED AND SERVICED BY A QUALIFIED PERSON IN ACCORDANCE WITH THE NATIONAL AND LOCAL REGULATIONS IN FORCE IN THE COUNTRY OF INSTALLATION. ALSO TAKE INTO CONSIDERATION.

- **HEALTH AND SAFETY AT WORKS ACT**
- **IEE REGULATIONS**
- **BS CODES OF PRACTICE**
- **LOCAL AND NATIONAL BUILDING REGULATIONS**
- **LOCAL AND NATIONAL WATER REGULATIONS**



THIS APPLIANCE CAN BE USED BY CHILDREN AGED FROM 8 YEARS AND ABOVE AND PERSONS WITH REDUCED PHYSICAL SENSORY OR MENTAL CAPABILITIES OR LACK OF EXPERIENCE AND KNOWLEDGE IF THEY HAVE BEEN GIVEN SUPERVISION OR INSTRUCTION CONCERNING USE OF THE APPLIANCE IN A SAFE WAY AND UNDERSTANDING THE HAZARDS INVOLVED. CHILDREN SHALL NOT PLAY WITH THE APPLIANCE. CLEANING AND USER MAINTENANCE SHALL NOT BE MADE BY CHILDREN WITHOUT SUPERVISION.



DISCONNECT APPLIANCE BEFORE SERVICING, MAINTENANCE OR CLEANING.

 IF THE SUPPLY CORD IS DAMAGED, IT MUST BE REPLACED BY THE MANUFACTURER, ITS SERVICE AGENT OR SIMILARLY QUALIFIED PERSONS IN ORDER TO AVOID A HAZARD.

 DO NOT IMMERSE CORD, PLUG, OR WATER BOILER IN WATER OR ANY OTHER LIQUID.

 THE FLEXIBLE HOSE CONNECTED FROM THE OVER FLOW ALSO ACTS AS A VENT FOR THE APPLIANCE. UNDER NO CIRCUMSTANCES SHOULD THIS FLEXIBLE HOSE BECOME BLOCKED OR RESTRICTED IN ANY WAY.

 THIS APPLIANCE MUST ONLY BE USED FOR HEATING WATER.

 THE UNIT MUST BE INSTALLED ON A SOLID CONCRETE / BRICK WALL BY A QUALIFIED FITTER. BURCO DOES NOT ACCEPT ANY RESPONSIBILITY FOR THE SAFETY OF ANY UNIT NOT INSTALLED IN THIS WAY.

 DURING OPERATION PARTS & SURFACES MAY BECOME HOT – AVOID ACCIDENTAL CONTACT.

 THIS APPLIANCE IS NOT SUITABLE FOR OUTDOOR USE.

Introduction

Thank you for purchasing this Burco Autofill Water Boiler.

To ensure you obtain the full benefits from your new appliance:

- Please read this instruction book carefully and follow all advice given. Please pay particular attention to any warnings.
- If you are unsure of any aspects of the information provided, or the setup and performance of the product, please contact our Aftersales team on 0344 879 3470.

This boiler are intended for commercial use as detailed in these instructions. The Company has a policy of continuous improvement in product quality and design. The company therefore reserves the right to change the specification at any time.

Warranty Information

This Burco boiler comes with a comprehensive 1 year parts and labour warranty. If you have purchased a Burco boiler with a water filter, then the warranty is 2 years parts and labour.

If you experience any problems with the water boiler, please contact our Aftersales team on 0344 879 3470. To ensure we can offer you the best possible service, please ensure you have the product code and serial number available (from page 2).

Your warranty is given subject to the appliance being used in accordance with the instructions supplied and on the supply voltage marked on the rating label. It is also subject to fair wear and tear conditions. The warranty **does not** cover:

- Consequential damage arising out of any failure acceptable under warranty.
- Accidental damage or misuse as detailed in these instructions.
- Unauthorised alterations made to the appliance that aren't made by a Burco-approved engineer.
- Consumable items such as filter cartridges.
- Any damage due to incorrect installation, or build-up of scale or food debris.

It is important that you descale your water boiler regularly, particularly in hard water areas.

⚠ Failure to descale your water boiler, or replace your filter cartridge when prompted to do so, will invalidate your warranty.

Accessories Kit



Technical Data

Model	3L	5L	7.5L	10L
Height (mm)	301	486	451	586
Width (mm)	344			
Depth (mm)	234 (310 inc. tap)			
Capacity (Litres)	3	5	7.5	10
Weight (Kg) *dry	5.8	7.7	7.4	8.4
Ambient Temperature	5°C – 30°C			
Water Inlet Pressure	1 - 8 (Bar)			
Voltage	220-240V (50/60Hz)			
Power Rating	3kW			

Installing Burco boiler

Mounting to wall

Please ensure there is at least 220mm of clearance below the boiler to allow for filter changes, the location must be frost free.



The unit must be installed on a solid concrete / brick wall by a qualified fitter. Burco does not accept any responsibility for the safety of any unit not installed in this way.

1. Mark the position of the 2 mounting holes 300mm apart as shown in the diagram below.
2. Ensure the marked positions are level.
3. Drill the wall and insert suitable wall plugs and screws.
4. Fix the wall bracket, from the accessory kit, to boiler. 4.5mm hole screws to boiler, this screw is included and can be found in the base of the boiler.
5. Hang the boiler on the two top lugs and locate the third hole position,
6. Drill the wall and insert suitable a wall plug.
7. Fix the boiler to the wall using a suitable screw.

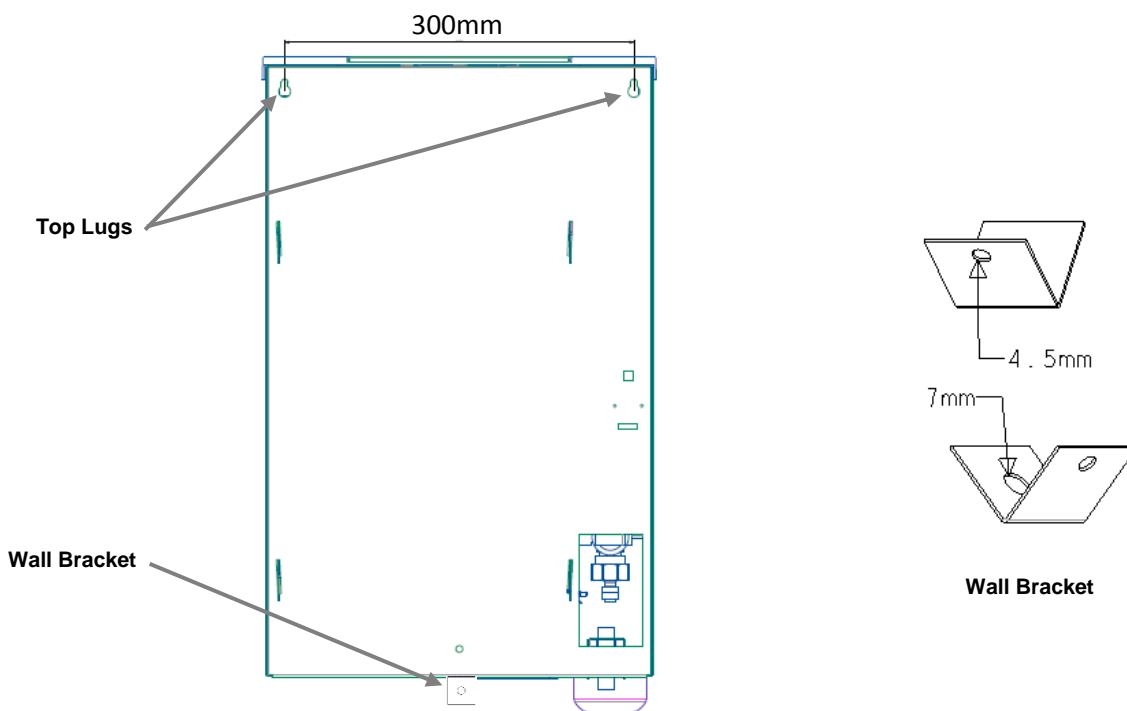



Before connecting to the power supply

- Remove all packaging and plastic coating from the appliance
- Check the unit has not been damaged in any way during transportation. Report any damage to the company who sold you the boiler right away.
- Check the available power supply corresponds to that shown on the rating label of the appliance, which must be A.C. (Alternating Current).
- Ensure the yellow steam cap is removed from the steam vent prior to powering appliance.

Connecting to the water supply

- Connection to the cold water supply and the appliance should only be made by the hose supplied.
- In hard water areas, it is always advisable to fit an inline filtration unit to limit scale build-up. If you have purchased a Burco boiler that does not have a water filter system included, we recommend you fit a separate water filter between the boiler and the mains supply.
- Always ensure mains water supply is turned off, or localised isolation valves are closed before attempting to connect boiler to the mains water supply.
- The inlet water connection to the inlet solenoid valve is $\frac{3}{4}$ " BSP, this should be connected to the mains water supply via an accessible isolating tap.



1.

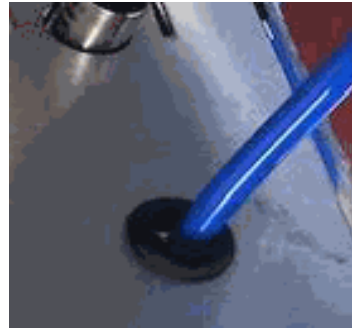

2.

- The blue pipe at the bottom of the boiler connects to the grey fitting which is shown in picture 1 above.
- Firmly push the blue pipe into the small outlet hole on the grey fitting.
- Ensure grey connection is screwed tight on the mains water supply and not leaking, forming a cold water feed from the mains water supply to the Burco boiler.
- Do not use old water hoses.



Venting

- There is a possibility the steam vent may discharge hot or cold water and/or steam into the local vicinity of the boiler. If uncontrolled, steam or water damage may occur in this area. It is recommended that the vent on the base of the boiler is plumbed to a safe visible location.
- Please ensure that any building and/or water regulations are fully adhered to.

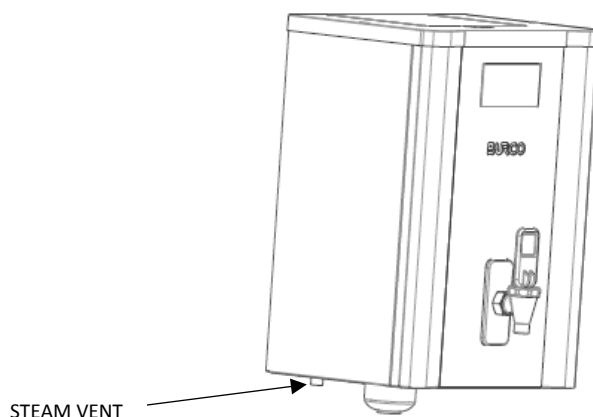

Electrical Connection

Electrical Safety

- All electrical work must comply with all relevant wiring regulations and carried out by a qualified electrician.
- To protect against fire, electric shock and personal injury, do not immerse cord, plug, or water boiler in water or any other liquid.
- If the supply cord is damaged, it should be replaced by the manufacturer, its service agent or similarly qualified persons in order to avoid hazard.



This appliance must be earthed.



The wires in the mains lead are coloured in accordance with the following code:

Green & Yellow Wires	Earth	E
Blue Wire	Neutral	N
Brown Wire	Live	L

Means of isolation with at least 3mm contact separation in all poles must be incorporated into fixing of this appliance.

The fixed wiring insulation must be protected by insulated sleeving having a temperature of at least 60°C. Supply cords should be oil resistant, sheathed flexible cable not lighter than ordinary polychloroprene or equivalent elastomer sheathed cord (code 60245 IEC 57)

The appliance is supplied with a terminal block suitable for flexible wires up to 6mm².

Overflow and Drainage

As an option, the boiler overflow outlet may be connected to a drainage system.



There may be some steam emitted from the vent at the base of the appliance during the initial fill stages (or if the tank is refilled after being fully emptied) but this will reduce as the volume of water increases in the tank. As an alternative, a flexible hose may be used redirected steam to a sink/draining board.



The flexible hose connected from the over flow also acts as a vent for the appliance. Under no circumstances should this flexible hose become blocked or restricted in any way.

Disposal

At the end of the appliances useful life, it should not be disposed of with household waste. Please recycle where facilities exist. Check with your local authority for recycling facilities and advice in your area.



This appliance can be used by children aged from 8 years and above and persons with reduced physical sensory or mental capabilities or lack of experience and knowledge if they have been given supervision or instruction concerning use of the appliance in a safe way and understanding the hazards involved. Children shall not play with the appliance. Cleaning and user maintenance shall not be made by children without supervision

Operating Instructions

Burco boilers are designed for continuous operation and should only be switched off for the purpose of maintenance or emergency.

Boiler Overview



This product is supplied with a power cord. Connection to electrical outlet is required and should be carried out by qualified personnel to the appropriate standards. Appliance not available with a standard 13Amp UK 3 pin plug.

Controller Overview

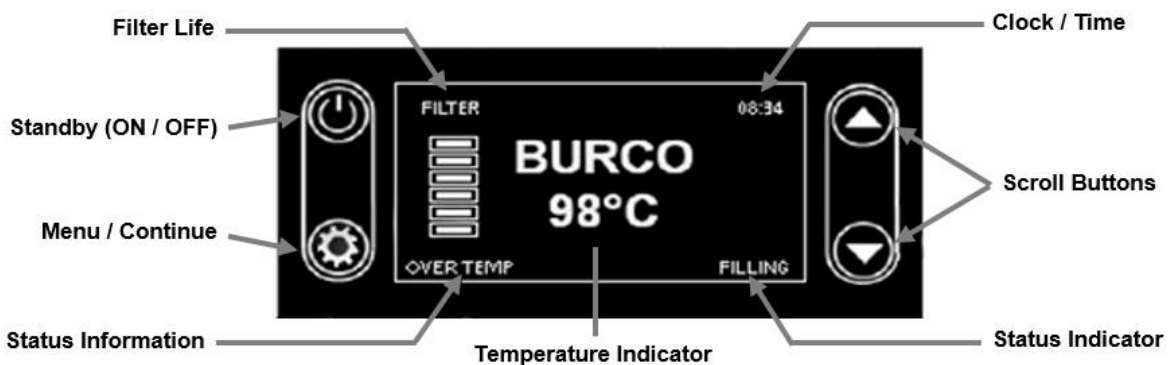

! Before general use, please follow these important commissioning steps:

- Ensure boiler is connected to the mains water supply.
- Turn on the mains power and press and hold the power button  for 10 seconds. The boiler should begin filling and heating.
- Ensure boiler is set to 98°C, fully drain the boiler contents from the tap and repeat. **Boiler should be fully drained twice before general use.**

Controller Set Up

Touch Screen Display (filtered models only):

The LCD screen will illuminate with the Burco logo. The default temperature and the time will flash waiting to be set. The hour figure will flash. Use the scroll buttons and press MENU to set when the correct time is shown. To change default temperature, press UP/DOWN SCROLL buttons to adjust to required temp.

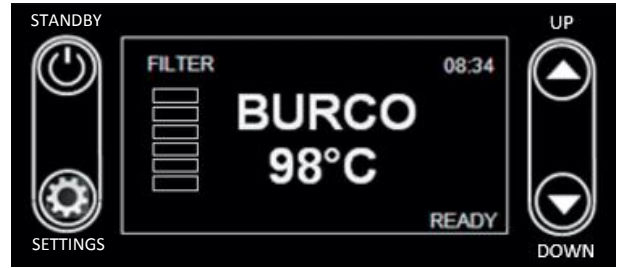

Touch Screen Safety Lock:

Pressing and holding both the MENU and the UP SCROLL button for 3 seconds activates the screen lock function. When the Screen Lock function is active settings cannot be changed. Press and hold the same buttons to deactivate the screen lock function. If in locked mode, the lock logo will blink on the screen for a couple of seconds if any button is pressed.



Set Time:

Press MENU, SET CLOCK will be highlighted. Press MENU to enter the SET CLOCK menu. The time will be displayed and the hour value will be flashing. Use the SCROLL buttons to select the correct value then press MENU. The minute values will now be flashing. Use the SCROLL buttons again to select the correct values. To store the time press MENU button again, this will also take you back to the SET UP menu. To exit the SET UP menu press the STANDBY button.

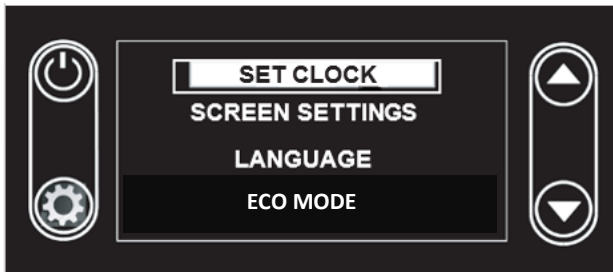

Set Temperature:

Use the UP and DOWN buttons to adjust the temperature. Press and hold the UP or Down button for 3 seconds before setting desired temperature.

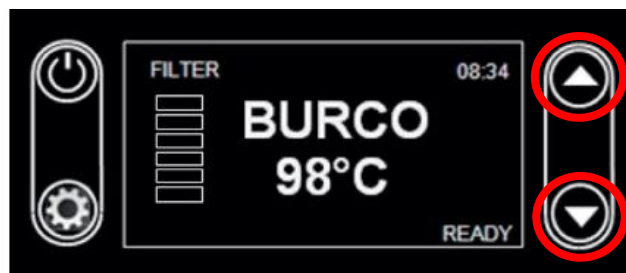

Screen Settings:

Press MENU and navigate down using the SCROLL button until SCREEN SETTINGS is highlighted, and then press MENU. For the backlight brightness, the values will flash. Use the SCROLL buttons to choose between 5 levels of backlight brightness. Hold MENU to store. Now the contrast values will flash. Repeat for the contrast. Hold MENU to store and to exit.

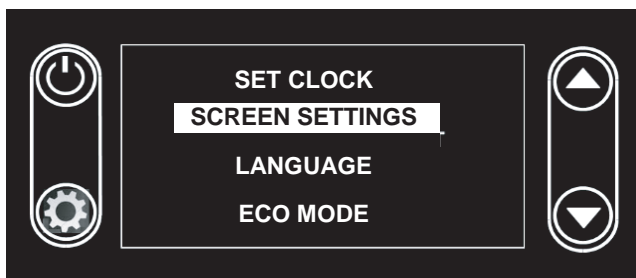

Language:

Press MENU and navigate down using the SCROLL button until LANGUAGE is highlighted, then press MENU. Scroll down to which language you want. Hold MENU to store and exit. Luxembourgish can also be selected in this menu.

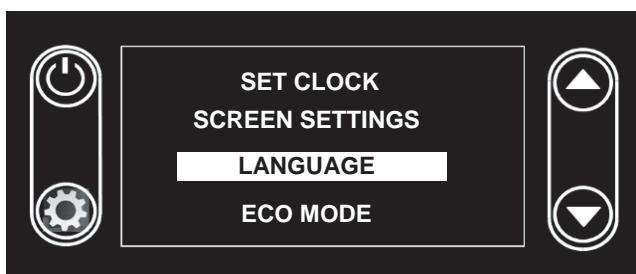

Eco Mode (Filter models only):

When no water is drawn from the boiler in 2 hours, the eco mode is engaged. The backlight turns off and the only data displayed is the Burco logo along with the time and the status indicator. Water should be drawn off to resume normal operation. To set the Eco mode timer, simply scroll down to 'ON' to set the desired time. Once you are happy with the time that has been set, press the menu button to confirm this. This will then take you to 'OFF', where you can then set the time that you want the Eco mode to finish. If you want to turn the Eco mode off altogether, simply scroll down and select 'OFF'.

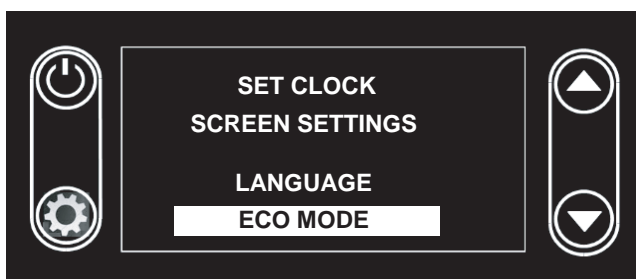

TO EXIT MENUS, PRESS THE STANDBY BUTTON



Heating up:

HEATING will flash on controller screen during the heating up period. LOW TEMP may be shown on the screen during this time. When selected temperature is achieved – READY is shown.



Filling:

Once the INITIAL SET UP is complete, the filling process will start. The LCD Screen will show the word FILLING. After the filling is complete, the heating will start until it reaches the set temperature. The LCD Screen will show the word HEATING.

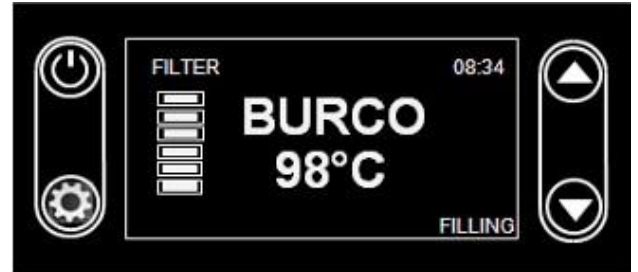

Filter Life (Filtration models only):

During operation, the bars fill to represent filter usage. Once exhausted, all the bars are solid and the fault code for changing the filter is displayed. The unit should be powered down. Filters replaced and filter counter reset (refer to replacement parts).



Power Down:

To power down the product, the STANDBY button should be held when on the normal operation screen for 10 seconds. The shutdown screen will appear and using the scroll buttons, 'Yes' should be selected by pressing MENU. The unit will then shutdown.

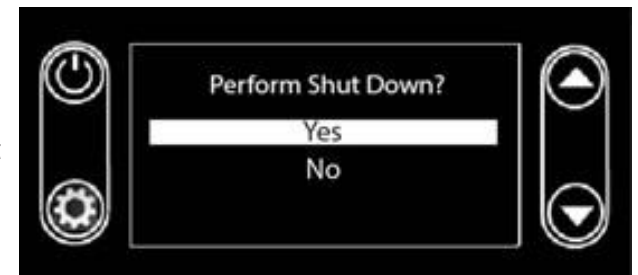

Tap function:

The tap can be changed between a controllable and constant flow. For 'Controllable' flow, simply pull the plastic handle away from you to dispense water and release to stop, see image 1. If you turn the plastic tap handle through 180 degrees, the tap will be in 'Constant' mode, see image 2. Now when you pull the tap towards you, it will remain locked downwards in an 'open' state until you lift the black handle back upwards to stop. The tap function is the same on tap models on both our Filtered and Unfiltered boilers.



1.



2.

! Always take care when operating the tap as the water will be boiling hot.

Cleaning and Descaling advice and information

Descaling

The descaling procedure must be performed by suitable personnel as it requires the removal of panels from the boiler and access to live electrical components. Always use a descaling agent suitable for stainless steel.

1. Isolate the boiler from electrical supply.
2. Allow the water to cool to approximately 60°C
3. Lift up the lid on the top of the boiler (Picture 1).
4. Twist the black tank cap **clockwise** and remove it. (Picture 2)
5. Add descaling agent through opening (Picture 3) in accordance with manufacturer's instructions.
6. Replace the black tank cap (**anti-clockwise**) and ensure it is secure.
7. Turn on the electricity and allow the boiler to operate normally for approximately 45 minutes.
8. Isolate / turn off the boiler and allow to cool down.
9. Remove the tank cap again, to inspect the tank and level detectors for scale deposits.
10. Drain and flush the de-scaling agent from the tank, using tap on the front of the appliance.
11. To drain the tank completely, remove panel under appliance (picture 4), locate the drain valve (picture 5) & attach overflow pipe (picture 6)
12. Connect a hose from the overflow pipe into a bucket and open the valve to drain the tank.
13. When empty, close the valve and replace panel removed in step 12.
14. Replace tank cap and lid.
15. Turn the boiler back on.



1.



2.



3.



4.



5.



6.

In hard water areas where a large build-up of scale has formed, you may need to physically scrape from the tank. If this is required, ensure care is taken and not to damage the level sensor probes.

It is important that you descale your water boiler regularly, particularly in hard water areas.

⚠ Failure to descale your water boiler, or replace your filter cartridge when prompted to do so, will invalidate your warranty.

Changing Water Filter (Filtered models only).

The boiler will alert when a new filter cartridge is required. The boiler should be descaled in conjunction with the filter change, see page 14 of instructions.



⚠ The water filter cartridge is unique to Burco. Only Burco “BC02” replacement filter (Part No. 01/74334/0) will fit these models. Please either purchase a replacement from your catering equipment supplier, or alternative order replacements via: ☎ **0344 879 3470** 🌐 **www.burco.co.uk**



1. Locate the filter below the boiler.



2. Twist cartridge anticlockwise & remove. (residual water may be present)



3. Remove all film and packing, insert new filter cartridge.



4. Twist the cartridge clockwise until locked in position.



5. To reset filter timer, PRESS & HOLD the UP & DOWN buttons until you hear a beep.

⚠ **Failure to use the correct filter cartridge will affect performance and invalidate the boilers warranty.**

Cleaning Instructions

It is recommend that your water boiler is cleaned on a regular basis. Failure to do so may result in the appliance not operating to its full potential and may invalidate your warranty.



Disconnect from the electrical supply before cleaning and allow water boiler to cool. Do not immerse the water boiler in water or any other liquids and take care to keep water away from the supply cord and connections. Do not use a water jet or steam cleaner.

External Cleaning

Wipe the external surfaces & dispensing tap of the appliance with a damp cloth. It is recommended that this is done daily to prevent lime scale build up. Stubborn stains may be removed using a good stainless steel cleaner or non-abrasive cleaner. Hard to reach areas should be cleaned using a soft brush & mild cleaning solution.

⚠ **Failure to clean on a regular basis may invalidate your warranty.**

Troubleshooting

If you believe your Burco Boiler isn't working correctly, please contact our Aftersales Team on 0344 879 3470.

Your boiler is fitted with a fault system that is able to detect fault conditions. Some of the conditions are less serious and the boiler will continue to operate normally, while other faults are more serious and will disable the appliance. Before calling the service line, switch off appliance at the main supply, then draw off a small amount of water and switch back on after 10 minutes. If the fault continues, please call the service line for advice on **0344 879 3470**

QR codes that appear on the screen can be scanned using an iPhone, Android and Windows device, which will take you to the Burco website.

Spare / Replacement Parts

 Genuine replacement Burco parts must be fitted. If generic non-Burco parts are fitted, you may prevent your appliance from operating safely and in the most efficient manner and also invalidate your warranty.

Examples of spare / replacement parts include:

- Element
- Solenoid Valve
- Electronic Controller
- Mains Lead (where applicable)
- Tap
- Filter Head
- Filter Cartridge
- Tank Cover
- Tank Cap

For further information or to purchase spare parts, please contact our Aftersales team on 0344 879 3470. Please ensure you have the details of the model and serial numbers to hand. These can be found in the "About my product" section on page 2. These can also be found on the data label at on the back of the appliance.

Frequently Asked Questions (FAQ's).

The following list of FAQ's may help you with any information or problems with your Burco boiler. Alternatively, please contact our Aftersales Team on 0344 879 3470 if your question is not covered below or if you aren't sure about something.

1. Are there any restrictions as to where I should locate my Burco water boiler?

- a. Yes, your appliance should be positioned on a flat, vertical wall that is capable of taking the weight of the appliance when full of water. Consideration must also be given to serving requirements and safe operational access to the appliance must also be ensured. For a detailed overview of installation requirements, please refer to page 6 of this instruction book.

2. There is no water coming from the tap?

- a. Check that the appliance is connected to mains power/water and that there is no blockage/kink in the supply hose.

3. My screen is not illuminating?

- a. Check the appliance is connected to mains power and turned on then adjust the brightness/contrast setting if required.

4. My boiler displays 'CHANGE FILTER'?

- a. Replace filter and reset the filter counter. If you need further help, see the demonstration video on our website at www.burco.co.uk/changefilter

5. The water from the tap is cold?

- a. Check appliance is connected to mains power and set temperature at the desired setting.

6. The water in my appliance has a strange taste?

- a. All new appliances must be heated and drained to sanitise. Follow the instructions outlined on page 9 to complete this process.

7. What Warranty does my water boiler have?

- a. Your Burco boiler will come with a 1 year parts and labour warranty. If you have purchased a boiler with a water filter, it will come with a 2 years parts and labour warranty. Please see the 'Warranty' section on page 5 for details.

8. My boiler doesn't seem to be heating what is wrong with it?

- a. It could be that your boiler requires descaling. Follow the instructions on page 14 to do this. **Regular descaling is the responsibility of the site.** If the boiler has not been descaled when our Service Engineer visits, the service call will be chargeable.

9. Can I purchase any replacement parts?

- a. Yes, we have a number of replacement parts available. If you require any spare parts, please do not hesitate to contact our Aftersales Team on 0344 879 3470 and they will be happy to assist.