

# Owner's Manual

FOR COMMERCIAL USE ONLY

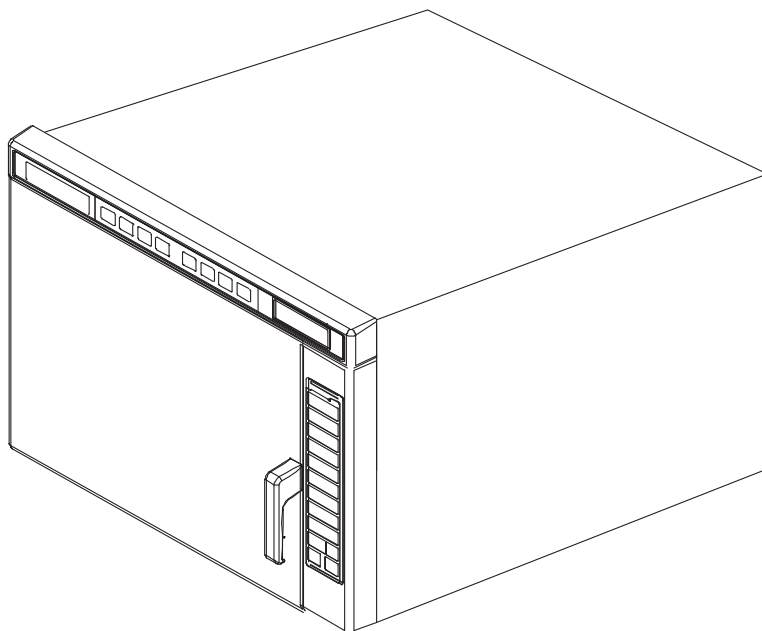

## Commercial Combination Oven (Microwave and Convection)

Keep these instructions for future reference. If the equipment changes ownership, be sure this manual accompanies equipment.

### Contents

Model Identification .....	2
Important Safety Information.....	3
Grounding Instructions .....	5
Installation .....	5
Display and Features .....	6
Programming.....	9
Convection Cooking .....	10
Combination Cooking (microwave and convection) .....	11
Microwave Cooking (microwave only).....	12
User Options .....	13
USB Flash Drive Operating Instructions .	14
Care and Cleaning .....	15
Before Calling Service.....	16

# Model Identification

When contacting ACP, provide product information. Product information is located on oven serial plate.

---

Record the following information:

Model Number: \_\_\_\_\_

Serial or S/N Number: \_\_\_\_\_

Date of installation: \_\_\_\_\_

Dealer's name and address: \_\_\_\_\_

\_\_\_\_\_

Any questions or to locate an authorized ACP servicer, call  
ACP ComServ Service Support.

– **Inside** the U.S.A. or Canada, call toll-free at 866-426-2621.

– **Outside** the U.S.A. and Canada, call 319-368-8120.

– **Email:** [CommercialService@acpsolutions.com](mailto:CommercialService@acpsolutions.com).

Warranty service must be performed by an authorized ACP servicer. ACP also recommends contacting an authorized ACP servicer, or ACP ComServ Service Support if service is required after warranty expires.

# IMPORTANT SAFETY INSTRUCTIONS

 **RECOGNIZE THIS SYMBOL AS A SAFETY MESSAGE**

## **WARNING**

When using electrical equipment, basic safety precautions should be followed to reduce the risk of burns, electrical shock, fire, or injury to persons including the following.

1. READ all instructions before using equipment.
2. READ AND FOLLOW the specific "PRECAUTIONS TO AVOID POSSIBLE EXPOSURE TO EXCESSIVE MICROWAVE ENERGY" on this page.
3. This equipment **MUST BE GROUNDED**. Connect only to properly GROUNDED outlet. See "GROUNDING / EARTHING INSTRUCTIONS".
4. Install or locate this equipment **ONLY** in accordance with the installation instructions in this manual.
5. Liquids or other foods, must **NOT** be HEATED in sealed containers since they are liable to explode.
6. Eggs in their shell and whole hard-boiled eggs should **NOT** be HEATED in microwave ovens since they may explode even after microwave heating has ended.
7. Use this equipment **ONLY** for its intended use as described in this manual. Do not use corrosive chemicals or vapors in this equipment. This type of oven is specifically designed to heat, cook, or dry food. It is not designed for industrial or laboratory use.
8. This appliance is **NOT** intended for use by persons (including children) with reduced physical, sensory or mental capabilities, or lack of experience and knowledge, unless they have been given supervision or instruction concerning use of the appliance by a person responsible for their safety
9. **CHILDREN SHOULD BE SUPERVISED** to ensure that they **DO NOT** play with the appliance
10. Failure to maintain the oven in a clean condition could lead to deterioration of the surface that could adversely affect the life of the appliance and possibly result in a hazardous situation;
11. See door cleaning instructions in the Care & Cleaning section of this product safety manual.
12. **DO NOT** heat baby bottles in oven. Baby food jars shall be open when heated and contents stirred or shaken before consumption, in order to avoid burns.
13. **DO NOT** operate this equipment if it has a damaged cord or plug, if it is not working properly, or if it has been damaged or dropped.
14. This equipment, including power cord, must be serviced **ONLY** by qualified service personnel. Special tools are required to service equipment. Contact nearest authorized service facility for examination, repair, or adjustment.
15. **DO NOT** cover or block louvers or other openings on equipment.
16. **DO NOT** store this equipment outdoors. **DO NOT** use this product near water – for example, near a kitchen sink, in a wet basement, a swimming pool, or a similar location.
17. **DO NOT** immerse cord or plug in water.
18. Keep cord **AWAY** from HEATED surfaces.
19. **DO NOT** let cord hang over edge of table or counter.
20. For commercial use only.

## **PRECAUTIONS TO AVOID POSSIBLE EXPOSURE TO EXCESSIVE MICROWAVE ENERGY**

- A. **DO NOT** attempt to operate this oven with the door open since open door operation can result in harmful exposure to microwave energy. It is important not to defeat or tamper with the safety interlocks.
- B. **DO NOT** place any object between the oven front face and the door to allow soil or cleaner residue to accumulate on sealing surfaces.
- C. **DO NOT** operate the oven if it is damaged. It is particularly important that the oven door close properly and that there is no damage to the:
  1. door (bent)
  2. hinges and latches (broken or loosened)
  3. door seals and sealing surfaces.
- D. The oven should not be adjusted or repaired by anyone except properly qualified service personnel.

**SAVE THESE INSTRUCTIONS**

## **WARNING**

To avoid risk of fire in the oven cavity:

- a. DO NOT overcook food. Carefully attend oven when paper, plastic, or other combustible materials are placed inside the oven, due to the possibility of ignition.
- b. Remove wire twist-ties from paper or plastic bags before placing bag in oven.
- c. If materials inside the oven ignite, keep oven door CLOSED, turn oven off and disconnect the power cord, or shut off power at the fuse or circuit breaker panel.
- d. DO NOT use the cavity for storage. DO NOT leave paper products, cooking utensils, or food in the cavity when not in use.

## **WARNING**

Liquids such as water, coffee, or tea are able to be overheated beyond the boiling point without appearing to be boiling due to surface tension of the liquid. Visible bubbling or boiling when the container is removed from the microwave oven is not always present. THIS COULD RESULT IN VERY HOT LIQUIDS SUDDENLY BOILING OVER WHEN A SPOON OR OTHER UTENSIL IS INSERTED INTO THE LIQUID. To reduce the risk of injury to persons:

- i. Do not overheat the liquid.
- ii. Stir the liquid both before and halfway through heating it.
- iii. Do not use straight-sided containers with narrow necks.
- iv. After heating, allow the container to stand in the microwave oven for a short time before removing the container.
- v. Use extreme care when inserting a spoon or other utensil into the container.

## **CAUTION**

To avoid personal injury or property damage, observe the following:

1. Do not deep fat fry in oven. Fat could overheat and be hazardous to handle.
2. Do not cook or reheat eggs in shell or with an unbroken yolk using microwave energy. Pressure may build up and erupt. Pierce yolk with fork or knife before cooking.
3. Pierce skin of potatoes, tomatoes, and similar foods before cooking with microwave energy. When skin is pierced, steam escapes evenly.
4. Do not operate equipment without load or food in oven cavity.
5. Microwave popcorn should not be popped in oven.
6. Do not use regular cooking thermometers in oven. Most cooking thermometers contain mercury and may cause an electrical arc, malfunction, or damage to oven.
7. Do not use metal utensils in oven.
8. Do not use aluminum foil in oven
9. Never use paper, plastic, or other combustible materials that are not intended for cooking.
10. When cooking with paper, plastic, or other combustible materials, follow manufacturer's recommendations on product use.
11. Do not use paper towels which contain nylon or other synthetic fibers. Heated synthetics could melt and cause paper to ignite.
12. Do not heat sealed containers or plastic bags in oven. Food or liquid could expand quickly and cause container or bag to break. Pierce or open container or bag before heating.
13. To avoid pacemaker malfunction, consult physician or pacemaker manufacturer about effects of microwave energy on pacemaker.
14. An authorized servicer MUST inspect equipment annually. Record all inspections and repairs for future use.

# SAVE THESE INSTRUCTIONS

## Unpacking Oven

- Inspect oven for damage such as dents in door or inside oven cavity.
- Report any dents or breakage to source of purchase immediately.  
**Do not attempt to use oven if damaged.**
- Remove all materials from oven interior.
- If oven has been stored in extremely cold area, wait a few hours before connecting power.

## Radio Interference

Microwave operation may cause interference to radio, television, or a similar oven. Reduce or eliminate interference by doing the following:

- Clean door and sealing surfaces of oven according to instructions in *Care and Cleaning* section.
- Place radio, television, etc. as far as possible from oven.
- Use a properly installed antenna on radio, television, etc. to obtain stronger signal reception.

## Oven Placement

- Do not install oven next to or above source of heat, such as pizza oven or deep fat fryer. This could cause microwave oven to operate improperly and could shorten life of electrical parts.
- Do not block or obstruct oven filter. Allow access for cleaning.
- Install oven on level countertop surface.
- If provided, place warning label in a conspicuous place close to microwave oven.
- Outlet should be located so that plug is accessible when oven is in place.

### Oven Clearances

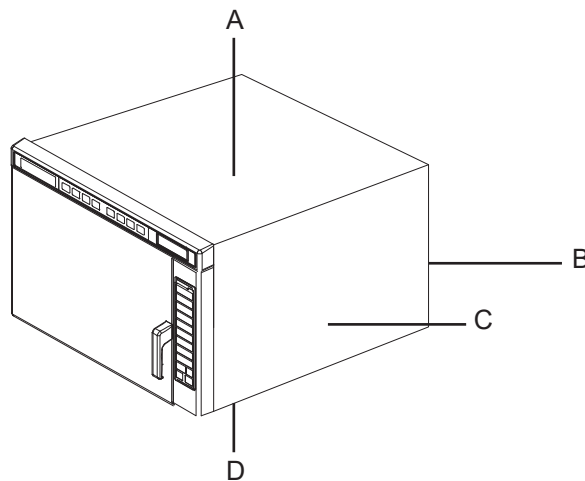

A—Allow at least 4" (10 cm) of clearance around top of oven. Proper air flow around oven cools electrical components. With restricted air flow, oven may not operate properly and life of electrical parts is reduced.

B—There is not an installation clearance requirement for the back of the oven.

C—Allow at least 1" (2.54 cm) of clearance around sides of oven.

D—Install combination oven so oven bottom is at least 3 feet (91.5 cm) above floor.

## WARNING

To avoid risk of electrical shock or death, this oven must be grounded and plug must not be altered.



## Earthing Instructions

Oven **MUST** be grounded. Grounding reduces risk of electric

shock by providing an escape wire for the electric current if an electrical short occurs. This oven is equipped with a cord having a grounding wire with a grounding plug. The plug must be plugged into an outlet that is properly installed and grounded.

Consult a qualified electrician or servicer if grounding instructions are not completely understood, or if doubt exists as to whether the oven is properly grounded.

### Do not use an extension cord.

If the product power cord is too short, have a qualified electrician install a three-slot receptacle. This oven should be plugged into a separate circuit with the electrical rating as provided in product specifications. When the combination oven is on a circuit with other equipment, an increase in cooking times may be required and fuses can be blown.

## External Equipotential

### Earthing Terminal (*export only*)

Equipment has secondary earthing terminal. Terminal provides external earthing connection used in addition to earthing prong on plug. Located on outside of oven back, terminal is marked with symbol shown below.



# Display and Features

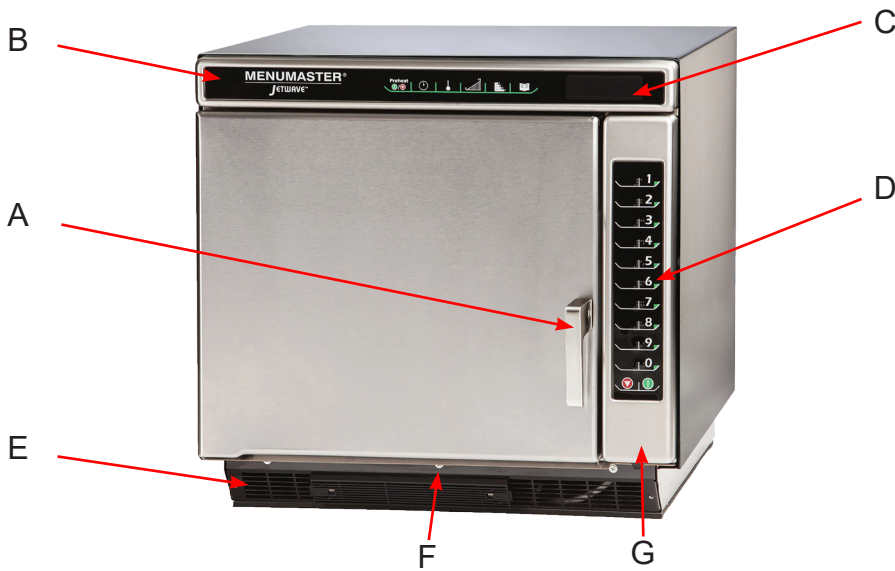

## Oven Features

- A—Oven Door Handle
- B—Top Control Panel
- C—Display
- D—Side Control Panel
- E—Magnetic Intake Air Filter
- F—Grease Tray
- G—USB Port

Standby shows in display after oven door has been opened and closed, or after turning oven OFF with the Preheat On/Off pad.

**STANDBY OR  
PRESS PREHEAT**

**OVEN PREHEATING  
475°F OR 250°C**

Oven Preheating and set temperature shows in display after pressing Preheat On/Off pad. (example of 475°F shown)

# Display and Features (cont'd)

Ready and set temperature displays after pressing Preheat On/Off pad. Ready indicates the oven is up to temperature. (example of 475°F shown)

READY  
475°F OR 250°C

Indicates oven is in a preprogrammed cooking program

ITEM-05      STAGE:1  
01:23 475°F      MW:50%

Cooking information shows in display after pressing a single (or double) digit pad while in Ready Mode.

Time left in cooking program

Cooking temperature  
475°F or 250°C

Percentage of microwave power

Indicates oven is in a manual cooking program

MANUAL      STAGE:1  
00:15 475°F      MW:100%

Time left in cooking condition

Cooking temperature  
475°F or 250°C

Indicates percentage of microwave power

Oven indicates it's in a Microwave Only mode prior to selection

ITEM-05      STAGE:1  
01:23      MW:50%

Cooking information shows in display after pressing a single (or double) digit pad while in Ready Mode.

Time left in cooking program

Percentage of microwave power

# Display and Features (cont'd)



## Start pad

The Start pad is used to begin a manual time entry cooking cycle.



## Stop/Reset pad

The Stop/Reset pad stops a cooking sequence in progress, clears out any remaining time, and also ends a programming or user option cycle. When the Stop/Reset pad is used to end a programming or option change, the changes are discarded.

## Temperature warnings

The combination oven has two distinct temperature warnings. Warnings sound with a three beep signal when a programmed pad is pressed. Warnings are:

- A warning when the preheat temperature does not match the preprogrammed temperature of a cooking condition.
- A warning when the actual oven cavity temperature is not to preheat temperature, such as when the oven is first started.

To override the warning and begin a cooking cycle, press the Start pad. To turn off warnings, see *User Options* section.

## Cooking Display

DISPLAYS	DESCRIPTION
OVEN PREHEATING 475°F	<b>Oven Preheating 475°F or 250°C</b> displays when oven is turned on and is warming up to the selected preheat temperature. <b>Oven Preheating</b> also flashes when a cooking condition can be started or programmed.
READY 475°F	<b>Ready 475°F or 250°C</b> displays when oven has reached preheat temperature and is ready to cook. <b>Ready</b> also flashes when a cooking condition can be started or programmed. <i>Note: Oven will shutdown after two hours of inactivity.</i>
00:00	Displays cooking time. If stage cooking is programmed, total cooking time is displayed
MW 50%	<b>MW 50%</b> displays the current microwave power level. 100% is the highest setting, and 0% is lowest (no microwave energy used).
ITEM-05	<b>ITEM-05</b> displays the single or double digit entry of a programmed cooking condition when using a programmed pad.
STAGE 1	<b>STAGE 1</b> displays the stage number (1 through 4) the oven is at in the cooking condition
STANDBY	<b>STANDBY</b> displays when oven is turned off, and also after the oven is plugged in, the door is opened, and then shut.

## Programming Display

DISPLAYS	DESCRIPTION
ENTER PROGRAM TO ADD/REVIEW:	Displays when oven is in programming mode for single digit or double digit memory.
STAGE 1	Displays stage number during cooking or when programming a specific cooking stage. Stage number (1 through 4) indicates the stage that is being used.
USB Display	
DISPLAYS	DESCRIPTION
USB	Displays when keypad 5 is pressed and held and transfer to or from USB flash drive is ready



## Programming Pads

Oven is shipped from the factory for single digit programming. To change the oven default to double digit programming, see *User Option* section. To program the amount of time, power level, or temperature setting for a pad:

- Oven must be ON.
  - Press Preheat On/Off pad.
  - Oven Preheating 475°F or 250°C** shows in display with **Oven Preheating** flashing.
- Oven reaches preheat temperature.
  - Ready 475°F or 250°C** shows in display with **Ready** flashing. Press Program Save pad.
  - Programming mode begins.
  - Enter Program to Add/Review:** shows in display.
- Press pad to be programmed or reprogrammed.
  - Display will change to review all settings for the pad.
  - The pad number that is being programmed displays beside the word **ITEM**.
- Press Time Entry pad to program amount of cooking time.
  - Enter desired cooking time by using numeric key pads.
  - The total microwave cooking time (all stages combined) is 20 minutes.
- Press Temp Entry pad to program the cooking temperature.
  - Enter desired convection temperature by using numeric pads.
- Press Power Level pad to program level of microwave power.
  - For a lower microwave power, press pads 1 (for 10%) through 9 (for 90%). **0 turns off the microwave power and cooking is by convection only.**
  - Press any numeric key pad twice to set power level back to 100%.
- Press Program Save pad to save the program changes.
- To discard changes, press Stop/Reset pad.



## Programming Preheat Setting

The convection temperature setting can be set between 150°F to 475°F (65°C to 250°C). It is recommended to set the preheat setting to the most commonly used temperature for that oven. The factory default preheat setting is 475°F (250°C).

### To program the preheat setting:

- Turn oven on to set preheat.
- Press Program Save pad.
- Press Temp Entry pad.
- Enter desired temperature by using the numeric key pads.
  - Temperature must be entered in 5°F (5°C) increments. If not, the temperature will automatically change to the nearest 5°F (5°C).
- Preheat temperature is changed.



## What is stage cooking?

Stage cooking enables several different cooking cycles, or stages, to be used consecutively without repeated input from the user. Stage cooking can be set to defrost food initially, then cook it, and then keep the food warm until serving time.

## Programming Multiple Stages

Stage cooking allows consecutive cooking cycles without interruption. Up to four different cooking cycles can be programmed into a memory pad.

To use stage cooking:

- Follow steps 1 through 6 above.
- Press Stage pad.
  - This will begin programming for the next cooking stage.
  - Display indicates stage to be programmed.
  - Enter cook time, temp and power level as in steps 4, 5 and 6.
  - To enter another cooking stage for that pad, press Stage pad again.
  - Up to four different stages can be programmed.
- Press Program Save pad to save the program and changes.
- To discard changes, press Stop/Reset pad before pressing Program Save pad.



EXAMPLE OF STAGE COOKING CONDITIONS

	Stage 1	Stage 2	Stage 3	Stage 4
<b>Temp</b>	450°F (230°C)	450°F (230°C)	450°F (230°C)	450°F (230°C)
<b>Power</b>	100%	30%	0	50%
<b>Time</b>	2:30	1:30	1:30	1:00

# Convection Cooking



## CAUTION

To avoid risk of burns, handle utensils, rack, and door with care. Allow oven, utensils, and rack to cool before cleaning. Oven, utensils, and rack, become hot during operation.

To operate the oven for convection cooking only, you can use preprogrammed pads or manual time entry. **The following instructions are for convection cooking only.** For combination cooking, see that section.

## Convection Cooking

Convection cooking utilizes both a convection element and fan to evenly distribute heated air throughout the oven cavity. By circulating air, no hot or cold spots occur, creating a consistent temperature envelope around the food. These consistent temperatures cook food evenly and reduces cooking time. Oven will always operate in convection mode.

## Convection Cooking with Programmed Pads

1. Press Preheat On/Off pad to start the oven.
  - Oven begins a preheat cycle.
  - **Oven Preheating 475°F (250°C)** shows in display.
  - To change preheat temperature, see *Programming*.
2. Oven reaches preheat temperature.
  - **Ready 475°F (250°C)** displays.
3. Press selected pad, preprogrammed to 0% microwave.
  - If using single digit programming, press pad and oven begins automatically.
  - For double digit programming, press pads in proper sequence and oven begins automatically.
4. Cooking cycle begins
  - Preprogrammed cooking program, total cooking time, cooking temperature, percentage of microwave power, and stage are all displayed.
5. Oven finishes cooking sequence
  - An end of cycle beep signals the end of the cooking cycle.
  - **Done** shows in display.
  - **Oven interior and cooking dish will be hot.**
6. Press Preheat On/Off pad to shut off oven.



## Convection Cooking Using Manual Cooking Operation

1. Press Preheat On/Off pad to start the oven.
  - Oven begins a preheat cycle.
  - **Oven Preheating 475°F (250°C)** shows in display.
  - To change preheat temperature, see *Programming*.
2. Oven reaches preheat temperature.
  - **Ready 475°F (250°C)** displays.
3. Place food in the oven.
4. Press Time Entry pad.
  - Enter desired cooking time by using the numeric keypad.
5. Press Temp Entry pad if cooking temperature differs from preheat temperature.
  - Enter the new temperature.
6. Press Power Level pad.
  - Press pad 0 (for 0%) microwave. **0 turns off the microwave power and cooking is by convection only.**
7. If stage cooking is desired, press Stage pad and repeat steps 4, 5, and 6.
  - Up to 4 different stages can be programmed.
8. Press the Start pad to begin the cooking cycle.

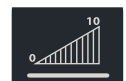

# Combination Cooking (microwave and convection)



## CAUTION

To avoid risk of burns, handle utensils, rack, and door with care. Allow oven, utensils, and rack to cool before cleaning. Oven, utensils, and rack, become hot during operation.

To operate the oven for combination cooking, you can use preprogrammed pads or manual time entry. **The following instructions are for combination cooking only.** For convection only cooking, see that section.

## Combination Cooking With Preprogrammed Pads

1. Press Preheat On/Off pad to start the oven.
  - Oven begins a preheat cycle.
  - **Oven Preheating 475°F (250°C)** shows in display.
  - To change preheat temperature, see *Programming*.
2. Oven reaches preheat temperature.
  - **Ready 475°F (250°C)** displays.
3. Press selected pad.
  - If using single digit programming, press pad and oven begins automatically.
  - For double digit programming, press pads in proper sequence and oven begins automatically.
4. Cooking cycle begins
  - Preprogrammed cooking program, total cooking time, cooking temperature, percentage of microwave power, and stage are all displayed.
5. Oven finishes cooking sequence
  - An end of cycle beep signals the end of the cooking cycle.
  - **Done** shows in display.
  - **Oven interior and cooking dish will be hot.**
6. Press Preheat On/Off pad to shut off oven.



## Combination Cooking

The combination mode uses both the speed of **microwave energy** and browning of **convection** cooking to yield fast, high quality food.

- Microwave cooking uses high frequency energy waves to heat the food. When cooking, microwave energy causes food molecules to move rapidly. This rapid movement between the food molecules creates heat, which cooks the food. POWER displays when oven is generating microwave energy for the current cycle.
- Convection cooking uses the selected oven temperature to bake and brown foods. The circulating air surrounds food in an envelope of evenly heated air.
- Oven will maintain a minimum convection temperature of 150°F (65°C) to ensure drier air and more even cooking.

## Combination Cooking Using Manual Cooking Operation

1. Press Preheat On/Off pad to start the oven.
  - Oven begins a preheat cycle.
  - **Oven Preheating 475°F (250°C)** shows in display.
  - To change preheat temperature, see *Programming*.
2. Oven reaches preheat temperature.
  - **Ready 475°F (250°C)** displays.
3. Press Time Entry pad.
  - Enter desired cooking time by using the numeric keypad.
4. Press Temp Entry pad if cooking temperature differs from preheat temperature.
  - Enter the new temperature.
5. Press Power Level pad.
  - For a lower microwave power, press pads 1 (for 10%) through 9 (for 90%). **0 turns off the microwave power and cooking is by convection only.**
  - Press numeric key pad for desired level. Press any numeric key pad twice to set power level back to 100%.
6. If stage cooking is desired, press Stage pad and repeat steps 4, 5, and 6.
  - Up to 4 different stages can be programmed.
7. Press the Start pad to begin the cooking cycle.



# Microwave Cooking (microwave only)



## CAUTION

To avoid risk of burns, handle utensils, rack, and door with care. Allow oven, utensils, and rack to cool before cleaning. Oven, utensils, and rack, become hot during operation.

To operate the oven for microwave cooking, you can use preprogrammed pads or manual time entry. **The following instructions are for microwave cooking only.** For convection only or combination cooking, see that section.

**Note:** Microwave Only option must be enabled from Options Settings on User Options page 13

## Microwave Cooking With Preprogrammed Pads

1. Place food inside oven and close door.
2. Press selected pad.
  - If using single digit programming, press pad and oven begins automatically.
  - For double digit programming, press pads in proper sequence and oven begins automatically.
3. Cooking cycle begins
  - Preprogrammed cooking program, total cooking time, cooking temperature, percentage of microwave power, and stage are all displayed.
4. Oven finishes cooking sequence
  - An end of cycle beep signals the end of the cooking cycle.
  - **Done** shows in display.

## Microwave Cooking Using Manual Cooking Operation

1. Place food inside oven and close door.
2. Press Time Entry pad.
  - Enter desired cooking time by using the numeric keypad.
3. Press Power Level pad .
  - For a lower microwave power, press pads 1 (for 10%) through 9 (for 90%).
  - Press numeric key pad for desired level. Press any numeric key pad twice to set power level back to 100%.
4. If stage cooking is desired, press Stage pad and repeat steps 2, and 3.
  - Up to 4 different stages can be programmed.
5. Press the Start pad to begin the cooking cycle.

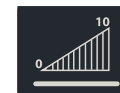

# User Options

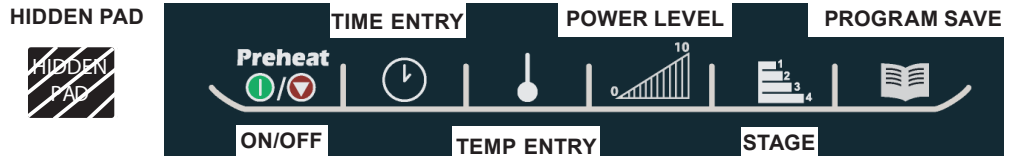

## Changing user options

Options such as single or double digit programming, beep volume, and maximum cooking time can be changed to suit individual preferences.

### Didn't like an option?

Factory settings are marked in bold. To change the oven back to the factory setting, simply select the option that is marked in bold.

### ? My changes weren't saved.

In order for any changes to be saved, the Program Save pad must be pressed after selecting an option. Pressing the Stop/Reset pad will not save changes.

#### TO CHANGE OPTIONS OVEN STANDBY MUST DISPLAY:

- Press hidden pad.
  - Pad is unmarked and located to the direct left of Preheat On/Off pad.
  - Nothing will be displayed when hidden pad is pressed.
- Press Program Save pad.
  - The first user option will display. Oven is now in options mode.
- Press number pad that controls option to be changed.
  - See table below for options.
  - Current option will display.
- Press numeric pad again to change the option.
  - Each time pad is pressed, option will change.
  - Match code displayed with code for desired option.
  - To change additional options, repeat steps 3 and 4.
  - Changes take affect after pad is pressed. Press Program Save to save.
- Press Stop/Reset pad to return to STANDBY, or open and close oven door.

NUMBERED PADS	DISPLAY	OPTIONS (FACTORY SETTINGS IN BOLD)
<b>1</b> Double Digit Entry	Disabled Enabled	Allows <b>10 (0-9)</b> preprogrammed pads. Allows 100 (00-99) preprogrammed pads.
<b>2</b> Manual Time Entry	Disabled Enabled	Manual time entry/cooking not allowed <b>Manual time entry/cooking allowed</b>
<b>3</b> Reset on Door Open	Disabled Enabled	<b>Opening oven door does not reset oven back to ready mode.</b> Opening oven door does resets oven back to ready mode.
<b>4</b> Keybeep	Keybeep On Keybeep Off	<b>Keys beep when pressed</b> Keys do not beep when pressed
<b>5</b> Keybeep Volume	Off Low Medium High	Keybeep volume OFF. Keybeep volume LOW. Keybeep volume MEDIUM. <b>Keybeep volume HIGH.</b>
<b>6</b> End of Cook Signal	Solid Beep <b>3 Second Beep</b> 4 Beeps Once 4 Beeps Repeating	Food done signal is a continuous beep until reset by user. <b>Food done signal is a three second beep.</b> Food done signal is four beeps, once. Food done signal is four beeps, four times.
<b>7</b> Keypad Active	15 seconds 30 seconds <b>60 seconds</b> 120 seconds Always	Keypad time entry window is 15 seconds. Keypad time entry window is 30 seconds. <b>Keypad time entry window is one minute.</b> Keypad time entry window is two minutes. Keypad time entry window is always active.
<b>8</b> Preheat Warnings	Disabled Program Warning Only Preheat Warning Only Both	<b>Both temperature warnings off.</b> Warning only when preheat temperature does not match preprogrammed temperature Warning only when actual oven cavity temperature is not to preheat temperature. Both temperature warnings on.
<b>TEMP PAD</b> Temperature Scale	Fahrenheit Celsius	Temperatures are displayed in °Fahrenheit for 60Hz models. Temperatures are displayed in °Celsius for 50Hz models.
<b>STAGE PAD</b> Clean Filter Message Frequency	Disabled <b>Weekly</b> Monthly Quarterly	Oven will not display "Clean Filter Message" <b>Oven will display "Clean Filter Message" every seven (7) days.</b> Oven will display "Clean Filter Message" every thirty (30) days. Oven will display "Clean Filter Message" every ninety (90) days.
<b>POWER LEVEL PAD</b> Microwave Only	Disabled Enabled	<b>Oven will not operate in "Microwave Only" mode.</b> Oven will operate in "Microwave Only" mode.

# USB Flash Drive Operating Instructions

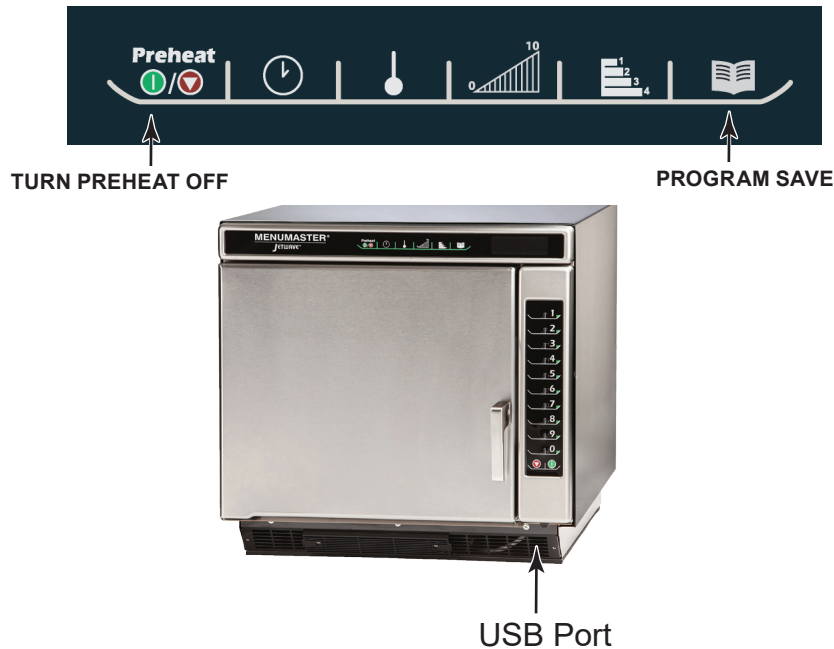

## To program the oven using USB Flash Drive:

Oven must be in Standby mode (Preheat must be OFF)

**Note:** A standard USB flash drive is compatible with oven.

1. Remove protective cover from bottom of vertical keypad.
2. Insert the USB Flash Drive into the slot located below the vertical keypad.
3. Open the oven door.
4. Press and hold the **5 pad** until USB appears in the display.
5. To transfer programming **FROM** the USB flash drive to the oven, press the **1 pad**. "USB TO OVEN" will appear in display.

**OR**

To transfer programming **TO** the USB flash drive from the oven, press the **2 pad**. "OVEN TO USB" will appear in display.

6. Press **START pad** , on vertical keypad to begin transfer.
7. Oven displays "LOADING" in the display for approximately 10 seconds.
8. When the transfer is complete the display will beep and display "DONE" and number of programs saved.
9. Press any pad to clear the display or shut the door and the display will read "READY".

### Error Codes:

1. **NO USB:** Remove flash drive from USB and reinsert flash drive into USB and retry.
2. **RESET OVEN:** Unplug oven from outlet and plug in oven and retry transfer.

# Care and Cleaning

Clean oven frequently to maximize oven life, performance, and efficiency. A dirty oven cooks inefficiently because moisture, spills, and grease absorb convection and microwave energy.

## WARNING

To avoid electrical shock which can cause severe personal injury or death, unplug power cord or open circuit breaker to oven before cleaning oven.



## CAUTION

To prevent burns, handle utensils, rack, and door with care. Allow oven, utensils, rack to cool before cleaning. Oven, utensils, and rack, become hot during operation.

**FOR A NEW OVEN:** before using it the first time, spray damp towel with ACP Oven Shield and wipe all interior surfaces. Do not remove Oven Shield Oven Protectant (Item# SH10). Turn oven on and pre-heat to start cooking.

### I. Daily Cleaning Recommendations:

**Recommended Cleaning Supplies:** damp towel, plastic scouring pad, ACP Oven Cleaner (Item # CL10) and ACP Oven Shield Oven Protectant (Item# SH10). Avoid spraying caustic cleaners or those containing ammonia, phosphates, chlorine, sodium or potassium hydroxide (lye) directly on oven surfaces.



**1. Shut oven off**  
Press the Preheat On/Off pad. Allow oven to cool down to 200°F (95°C) or lower (approximately 10-15 minutes with the door open and 45-60 minutes with the door closed).



**4. Clean and Wipe Oven Interior**  
Clean the oven using a composite scouring pad. Wipe the oven interior using a damp clean towel, rinse towel and wring dry. Repeat 2-3 times to remove remaining oven cleaner and particles from the oven. If needed, repeat steps 3 and 4.



**2. Remove rack and accessories.** Wash with warm soapy water and allow to air dry while cleaning oven interior. Clean pizza stone by using a plastic scraper and a damp cloth only.



**5. Spray Oven Shield:**  
When oven is clean, spray cavity with SH10 Oven Shield and wipe all interior surfaces. Place rack back in oven. Do not remove Oven Shield.



**3. Spray Oven Interior.** Remove baked on particles using a plastic scraper. Wear gloves and safety glasses. Spray oven door, sides and floor with CL10 Oven Cleaner. Allow to soak for 2-5 minutes.



**6. Clean Oven Exterior:**  
Clean exterior door and other surfaces with clean cloth, sponge or composite pad, and warm soapy water.

### II. Weekly, Monthly or Quarterly Cleaning: Clean Air Filter and Grease Tray



Filter and grease tray is located below oven door. Filter is magnetic, remove filter for cleaning and wipe surrounding louvers. Wash filter using a sponge or composite pad and warm soapy water. Pull grease tray out, drain grease and clean using a sponge or composite pad and warm soapy water. Rinse and dry thoroughly.

### Note:

- Remove food from oven at end of cycle.
- Wear protective rubber gloves when cleaning oven.
- Remove baked on particles using a plastic scraper.
- Avoid spraying caustic cleaners or those containing ammonia, phosphates, chlorine, sodium or potassium hydroxide (lye) directly on oven surfaces.
- Use only accessories that are both high temperature oven-safe and microwave-safe in the oven.
- DO NOT use a water-pressure type cleaning system.
- DO NOT cook foods contained in plastic wrap.
- DO NOT use metal foil in the oven. You may use drip tray accessory (DR10) to line oven.
- Metal pans with no more than 1 inch deep are acceptable. Assure pans do not contact oven or door surfaces during cooking.

Any questions please refer to MSDS of oven cleaner or contact ACP, Inc. ComServ at 866-426-2621.

# Before Calling for Service

## **WARNING**

To avoid electrical shock which can cause severe personal injury or death, do not remove outer case at any time. Only an authorized servicer should remove outer case.  
This is a Class A product. In a domestic environment this product may cause radio interference in which case the user may be required to take adequate measures.

<b>PROBLEM</b>	<b>POSSIBLE CAUSE</b>
Oven does not operate.	<p>Confirm oven is plugged into dedicated circuit.</p> <p>Confirm oven is on grounded circuit. (Contact electrician to confirm)</p> <p>Check fuse or circuit breaker.</p>
Oven operates intermittently or <b>HOT</b> shows in display.	Check air filter and discharge areas for obstructions.
If oven does not accept entries when pad is pressed.	<p>Make sure oven is on and preheated.</p> <p>Open and close oven door. Press pad again.</p>
<p>If oven malfunctions or shows:</p> <p><b>ERROR!</b></p> <p><b>ERROR CODE: 1</b></p> <p>(example)</p>	<p>Oven control is equipped with a self-diagnostic system. Self-diagnostic system alerts you if there is an error or problem. When electronic control signals a problem, follow steps listed below.</p> <ol style="list-style-type: none"> <li>1. Record number shown. (example of Error Code: 1 shown)</li> <li>2. Unplug oven, wait for 1 minute. Then plug in oven. <ul style="list-style-type: none"> <li>• If code does not reappear, continue normal use with the oven.</li> <li>• Disconnecting electrical supply may eliminate service code.</li> <li>• If failure continues, contact an authorized servicer. Do not use oven until contacting the ACP Servicer.</li> </ul> </li> </ol>
Oven fan turns on while oven is not preheating or cooking.	Normal operation.

For full product documentation visit:  
[www.acpsolutions.com](http://www.acpsolutions.com)