

# INSTRUCTION MANUAL

2021



## **TEFCOLD EXPRESS**

**Refrigerated Display Cabinets**

**Chilled Open Fronted & Full Glass Door Integral Multi-Decks**

## Table of Content

1	Introduction .....	4
1.1	Important Notes.....	4
1.2	Product Temperature Classes .....	5
1.3	Climate Classes.....	5
1.4	Air Velocity.....	5
1.5	Safety Instructions .....	5
1.6	Electrical Safety Tests (EST).....	6
1.7	Risk Analysis .....	7
1.8	Working with Refrigerant R290... ..	7
2	Cabinet Use	10
2.1	Important .....	10
2.2	Shelf Loading for Proper Cold Air Circulation .....	10
2.3	Shelf Loading for Safety .....	11
2.4	Filling with products on starting up.....	11
2.5	Exterior factors for placing the cabinet .....	11
2.6	Cabinet Cleaning .....	12
2.6.1	Health & Safety Warnings and Information.....	12
2.6.2	General Requirements to be Considered During Cleaning .....	12
3	Troubleshooting .....	14
3.1	Recommendation.....	14
3.2	Cause – Recommended Solutions .....	15
4	Controls .....	17
4.1	How to Use “CAREL PJEZC Temperature Controller” .....	17
4.1.1	General Appearance.....	17
4.1.2	Introduction & General Descriptions.....	17
4.1.3	Display .....	17
4.1.4	Keypad.....	18
4.1.5	Functions Available from the Keypad .....	18
4.1.6	Alarms .....	19
4.1.7	Temperature Control.....	19
4.1.8	Liquid Management .....	19
5	Controller Setting Parameters.....	20
5.1	CAREL PJEZC (MASTER) .....	20
5.1.1	Common Defrost .....	22
6	Wiring Diagrams .....	23
6.1	Tefcold Express EX125C OPEN FRONTED .....	23
6.2	Tefcold Express EX187C OPEN FRONTED .....	24

6.3	Tefcold Express EX250C OPEN FRONTED .....	25
6.4	Tefcold Express EX125CD WITH DOOR .....	26
6.5	Tefcold Express EX187CD WITH DOOR .....	27
6.6	Tefcold Express EX250CD WITH DOOR .....	28
7	Cabinet Technical Details.....	29
7.1	Side Elevations .....	29
7.1.1	Open Fronted .....	29
7.1.2	Double Pane Glazing Door (Hinged) .....	30
7.1.3	Case lengths .....	30
7.2	Cabinet Data Plate Descriptions.....	33
7.3	Refrigeration .....	34
7.4	Noise Breakout.....	34
8	Service and Maintenance .....	35
8.1	Access to fans.....	35
8.2	Access to drainage outlets .....	35
8.3	Access to cabinet electrics and controls .....	35
8.4	Condensing Unit Access .....	36
8.5	Refrigeration, Electrical and Drainage Connections.....	37
8.5.1	Refrigeration .....	37
8.5.2	Refrigerant Charge Limits.....	38
8.5.3	Electricity.....	38
8.5.4	Plugs.....	39
8.5.5	Cabinet Lighting.....	39
9	Instructions for Delivery .....	40
9.1	Transportation .....	40
10	Installation .....	41
10.1	Unpacking .....	41
10.2	Minimum Clearances for Placing the Cabinet .....	41
10.3	Removing from Wooden Pallet.....	42
10.4	Levelling and Door Alignment (if fitted).....	43
10.5	Assembly of Wall Spacers .....	46
10.6	Shelf profiling & Fitting of accessories .....	46
10.7	Power Supply .....	49
11	Dismantling and Disposal.....	51
12	Maintenance.....	52

## ▪ Introduction

The TEFCOLD EXPRESS cabinets are retail refrigerated display cabinet with integrated condensing units for displaying chilled food. This cabinet is designed and built at TEFCOLD for storing chilled products. It cannot be used to cool hot and/or non-chilled products.

This manual has to be read before handling or installing or using the product. This manual contains necessary information about installation at the beginning, maintenance operation during cabinet life and important Health & Safety considerations.

TEFCOLD Refrigeration reserves the right to change at any moment any part or any information in this document to achieve better and safer product usage.

### .1 Important Notes



The manual is an integral part of the equipment and should always accompany the product in the event of a transfer to a new location or to a new owner. The user is responsible for the integrity of these documents, for their consultation and during the whole life cycle of the equipment itself. Keep this manual in a safe place. It should be available for consultation near the equipment at all times. If lost or destroyed, you can request a copy of the manual from **TEFCOLD** by specifying the exact model, serial number and year of manufacture.

This equipment is not intended for use by persons (including children) with reduced physical, sensory or mental capabilities or by persons lacking the necessary experience and knowledge, unless they are supervised by a person responsible for their safety who has instructed them on how to use the equipment.

Always refer to this manual before going ahead with any operation. Before doing any type of work, disconnect the equipment from the power supply. Any work on electric and electronic parts or cooling system components should only be carried out by trained personnel in compliance with current laws.

The Manufacturer cannot be held liable for any injury to persons or animals, or damage to the product itself in the event of:

- improper use of the equipment or use of the appliance by unqualified or unauthorised personnel
- failure to comply with current legislation
- incorrect installation and/or power supply faults;
- failure to observe the instructions contained in this Manual;
- failure to follow the maintenance programme;
- Unauthorised modifications;
- installation of non-original spare parts in the equipment;
- installation and use of the equipment for purposes other than those for which the appliance was designed and sold;

The buyer is responsible for training personnel using the appliance on the risks, safety devices and general health and safety rules required by the laws of the country where the appliance is installed.

Users/operators should be aware of the position of all the controls and how they work, as well as of the features of the appliance.

They should also read this manual in it's entirely.

Maintenance work should be conducted by qualified personnel after the appliance has been prepared adequately.

## **.2 Product Temperature Classes**



PRODUCE & BWS	<b>H1</b> (warmer than or equal to +1°C, colder than or equal to +10°C)
DAIRY	<b>M2</b> (warmer than or equal to -1°C, colder than or equal to +7°C)
MEAT	<b>M1</b> (warmer than or equal to -1°C, colder than or equal to +5°C)

## **.3 Climate Classes**



The TEFCOLD EXPRESS cabinets are designed to maintain nominal product temperatures above referring to EN ISO 23953-2:2015 in an ambient environment of 25°C dry bulb temperature and 60% relative humidity (Class3).

<b>CLASS 3</b>	Dry Bulb Temperature	25°C
	Relative Humidity	60%
	Dew Point	16.7°C
	Water vapour mass in dry air	12.0g/kg

Ambient environment tolerances are;

- $\pm 1$  °C of the dry bulb temperature (warmer than or equal to +24°C, colder than or equal to +26°C)
- $\pm 3$  units of the relative humidity percentage (higher than or equal to 57%, lower than or equal to 63%)

This means that to achieve the product temperatures the refrigeration system and in particular the air-cooled condenser are designed to reject heat operating to the conditions at the tested parameters. Any deviation in these parameters may influence the overall performance of the refrigerated case affecting the product temperatures.

## **.4 Air Velocity**



The horizontal air currents parallel in front of the cabinet shall lie between 0,1m/s and 0,2m/s (in longitudinal direction).

## **.5 Safety Instructions**

TEFCOLD recommend that any person who interacts with the cabinet or cabinet sub components reads these instructions completely before starting to operate the equipment.

Only authorised, qualified, competent personnel can be involved with the installation, setting to work or carrying out service and maintenance on this equipment.

The water which comes from the cabinet's evaporator during defrost period, has to be drained to the two drip trays, one evaporates water from the condenser pipework, if

this reaches its capacity it drains into a drip tray controlled by an electrical heater to evaporate the water.

Sections with the below sign, should only be accessed by authorized personnel. Do not forget that electricity can be fatal.



Do not store explosive substances such as aerosol cans with a flammable propellant in this cabinet.



***Follow the instructions below in a case of gas escape or fire:***

- If there is gas escape from the refrigerator, ventilate the room. If it cannot be ventilated leave the room.
- In case of fire follow the fire safety instructions applicable to that location.

## **.6 Electrical Safety Tests (EST)**

Making a product “safe” requires an understanding of the “hazards” that exist in each electrical product. Certain potential hazards are inherent in all electrical products because of the manner in which they are powered and how they perform their intended functions. Even though a product requires an electrical power source and uses electrical or electronic components, it should not present an electrical shock hazard to the user.

Every single cabinet manufactured by TEFCOLD is subjected to stringent electrical tests below in compliance with EN60335.

Electrical shock hazards are prevented by TEFCOLD with following Electric Safety Tests:

1. Dielectric Withstand Tests
2. Insulation Resistance Tests
3. Leakage Current Tests
4. Ground Continuity Tests
5. High Voltage Tests
6. TEFCOLD highly recommend that the cabinet is only connected to a power supply protected by an earth leakage relay,
7. In the event of an electrical fault the equipment must be electrically isolated immediately and power must not be restored until authorised by competent electrical personnel.

## .7 Risk Analysis

The below Risk Analysis tables show potential problems and who may be affected. The aim of these tables is to prevent possible problems or injuries before they occur.

### • Use of electrical Isolator

WHO	WHAT	REDUCTION
Store personnel	Electrical Shock	Live parts mech. covered
Store personnel	Falling whilst using isolator	Correct use approved steps

### • Electrical Maintenance

WHO	WHAT	REDUCTION
Maintenance Personnel	Electrical Shock	Isolate before working
Maintenance Personnel	Falling whilst using isolator	Correct use approved steps

### • Cleaning cabinet

WHO	WHAT	REDUCTION
Cleaning personnel	Strain	Only lift single panels
Cleaning personnel	Scratch and impact	Training in correct method
Others in area	Scratch and impact	Clean when store closed

### • Cleaning Fans and Drain Area

WHO	WHAT	REDUCTION
Cleaning personnel	Revolving fan blades	Electrically isolate cabinet Fans protected by guards
Cleaning personnel	Bending down low	Training in correct method
Others in area	Scratch and impact	Clean when store closed

## .8 Working with Refrigerant R290

Only qualified Refrigeration Engineers with the appropriate qualification may work on this equipment. In particular, the refrigeration system must only be opened and worked on by qualified persons



## 2. Cabinet Use

### .1 Important



- Do not put warm or un-chilled products into the cabinet. It is designed to hold pre-chilled products, not to cool them.
- Do not leave the cabinet doors open (if fitted).
- Do not block the space between the front of the shelves and the glass with product, signage or point of sale as this will affect airflows resulting in warm products.
- Do not block the grilles at the front of the cabinet or stack products in front of them as this will cause the cabinet to overheat and stop working correctly.
- Do not overload the shelves or block the grilles inside the cabinet. The cabinet requires air space to allow the cold air to circulate around the cabinet.

## . 2 Shelf Loading for Proper Cold Air Circulation



Always allow air space between the products in order to maintain cold air circulation and do not block air grills. Failure to enable cold air to circulate as designed can lead to product temperature not being maintained and can affect the functionality of the cabinet refrigeration system.

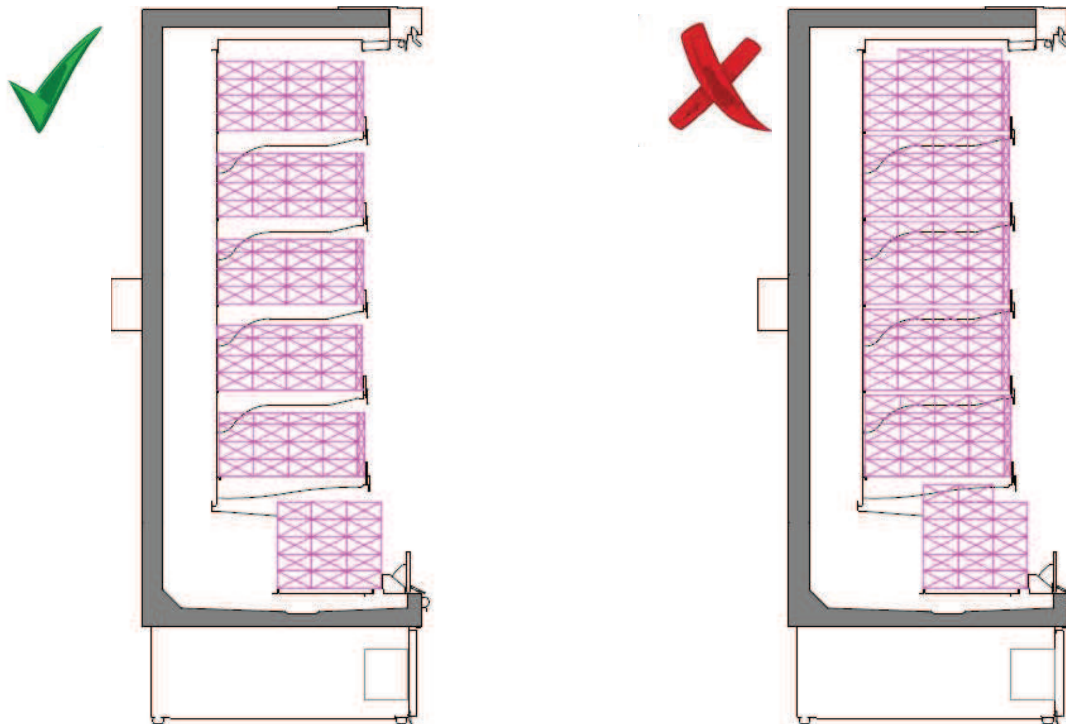

## .3 Shelf Loading for Safety

Merchandising of the cabinet must be equally distributed through the cabinet. Heavy weighted products must be placed to deck tray or closer for rigidity of cabinet. Start product loading from deck tray, if some part of the cabinet is going to be left empty, for product loading prefer lower shelves not the top ones.

## .4 Filling with products on starting up

After turning on the cabinet for the first time or when it has been turned off for cleaning it is necessary to allow the cabinet to cool down to operating temperature before loading products. Wait minimum 2 hours after turning on before merchandising.

## .5 Exterior factors for placing the cabinet



- Ambient temperature and humidity values should not exceed 25°C DBT / 60%RH (Class3; EN ISO 23953).
- Horizontal air velocity measured in front of the cabinet shall lie between 0,1m/s and 0,2m/s.
- Check the air conditioning, ventilation and heating devices in the shop are working efficiently.
- Air stream and air intakes should not be directed towards the cabinet openings and the goods displayed should not be exposed to direct sunlight.
- Prevent the temperature increment of radiating surfaces in the shop. e.g. ceiling installation.



- Check for other sources of radiant heat in the area and eliminate e.g. sun shining through roof lights or windows, heated pipework, heated display cabinets and cooking equipment.
- The air inlets and vents on the cabinet should not be closed with products, labels, and accessories.



## .6 Cabinet Cleaning

### 2.6.1 Health & Safety Warnings and Information

Switch off power supply of the cabinet from the main switch.



To minimise shock and fire hazards, please do not plug or unplug the unit with wet hands.



Care must be taken when handling or working on the unit as sharp edges may cause personal injury, we recommend the wearing of suitable PPE.

Ensure the correct moving and lifting procedures are used when relocating a unit.



Around of the cabinet can be wet and slippery.



Do not touch hot, cold and moving parts.

### 2.6.2 General Requirements to be Considered During Cleaning



Neutral detergents, soap and water should be used for cleaning the parts.

Rinse with clean water and dry with a soft cloth.

It is recommended that the drainage is kept clear and free running by pouring clean water down the drain every 3 months.

Rinse and remove water and debris using a wet vac.



Clean glass surfaces using glass cleaning products. Never use hot water on glass as this may 'shock' the glass, causing the glass shatter due to sudden temperature change.



Stainless steel can be subject to surface discoloration or “tea staining”. This can be removed with an appropriate cleaning agent that contains 10% Sodium citrate.



Do not use abrasive products and solvents that may cause any scratches to the surface of the cabinet. Never scour with hard objects any parts of the cabinet. Scouring pads, steel brushes, screwdrivers or chemicals may cause damage by scratching or dulling polished surface finishes.



Never clean components using inflammable materials, such as alcohol, acetone or solvents.

Never use high-pressurized water.



Do not directly apply water to fan motors or any other electrical components in the cabinet. Always be careful to minimize moisture on and near the electrical components. Cleaning of electrical components must be done by Qualified Maintenance Technician.

When working inside the cabinet takes care not to damage any components such as fan blades or probes and ensure no strain is put on any cables.

Once a final check has been carried out to ensure the display cabinet is fully assembled the electrical isolator should be unlocked and turned on. The cabinet will start to operate again.



The alarms can then be re-activated, double check that alarms are operational before allowing the display to be re-merchandised.

### 3. Troubleshooting

Should your cabinet not be operating efficiently?







Before calling the technical service, check these points given in sections 3.1 Recommendation and 3.2 Cause – Recommended Solutions can be used for troubleshooting.

#### .1 Recommendation

Check following conditions:

- Only products which are already refrigerated to the correct cold chain temperature should be loaded in to the cabinet.
- The cabinet temperature should be stable.
- Do not overload the cabinet; take the loading limit into consideration.
- Considering the foodstuff turnover, the first loaded goods should be sold first. (Apply first in first out procedure.)
- Check the displayed foodstuff and the operation temperature of the cabinet regularly at least twice a day.
- Replace the goods right away, if any failure occurs on the cabinet.
- If you find any fault parts, move it right away (burnt out LED lamps, loosened parts etc.).
- Is the case suffering from an increase in ambient temperature?
- The draining of the defrost water and the water evaporation should be checked regularly.
- If any unexpected condensation occurs than call a qualified refrigerator technician.

Malfunction	Causes 	Recommended Solutions 
Compressor is out of order	No power on compressor	Check if there is a power cut on the network Check if the power supply conditions are the same as it is defined in the technical label. Check if the board connections are tight.
	Either main isolator switch is closed or circuit breaker is blown	Check if the main isolator switch is on or there is any problem with circuit breakers
	Pressure switch has cut the circuit out	Manually reset HP pressure switch
	The cabinet is defrosting	Wait for one hour. If compressor still stays off, call for technical assistance
	Clogging of condenser	Clean the condenser
	Condenser fans fail to run	Call for technical assistance
	HP/LP pressure switch cuts-out compressor	Call for technical assistance
	Electronic controller is defective	Call for technical assistance
	Compressor works continuously	Compressor contactor is adhered or any other problem is occurred
The refrigerant is not adequate in the circuit		Call for technical assistance
Setting parameters are wrong		Check set value and other setting parameters
Cabinet is located in the wrong area and the condenser is unable to reject the heat		Check and relocate case to enable condenser heat to be rejected as designed
Cabinet is overloaded or storage of products is wrong		Check loading of products and analyse if any factor prevents air circulation
The cabinet has no capability of refrigeration	Clogging of condenser (condenser is dirty)	Clean up the condenser
	Compressor is out of order	Follow the instructions described above
	Clogging of evaporator (ice or snow formation)	Manually defrost the cabinet and check the setting values of the defrost
	Cabinet is overloaded or storage of products is wrong	Check loading of products and analyse if any factor prevents air circulation
	Cabinet is placed close to a heat or light source or affected by air movement	Change the position of the cabinet or remove the heat sources
	Setting parameter(s) is wrong	Check set value and other setting parameters
Illumination is not functioning	Lighting switch is off	Turn the switch on
	LEDs and/or LED driver(s) are defective	Replace
	Electrical system of the cabinet is malfunctioned	Call for technical assistance

Malfunction	Causes 	Recommended Solutions 
Abnormal sound from the cabinet	Some nuts, bolts or moving parts are loosened	Check and tighten. If it is necessary, replace
	Fans are touching an object or connection screws are loosened	Check if there is an object that touches the evaporator fans. Fix it by tightening the loosened parts
	A failure in mechanical parts	Call for technical assistance

### .3 Warranty Terms

A parts only warranty is valid for a period of 24 months from receipt of installed goods. During the warranty period, Tefcold will replace parts proved as faulty and as confirmed by their authorised service agent, free of charge (freight included) excluding labour costs for the replacement work. Tefcold reserves the right to invoice for the replacement or faulty parts until a further investigation has been undertaken to determine the root cause of the problem. A full credit note will be issued upon satisfactory inspection.

#### Warranty Exceptions

Unless confirmed as being damaged within 48 hours from initial delivery and installation, all cosmetic items and fabricated items are specifically not covered by the warranty.

- Shelves, front risers, ticket strips are specifically not covered
- LED lighting, door gaskets and trims are deemed consumable and not covered
- Other consumable items and breakables are not covered
- Refrigerant is specifically excluded from the warranty arrangements
- Stock loss due to unit failure or claims for consequential losses are excluded from warranty.

#### Important notes

- Warranty is not transferrable.
- Use of equipment other than for its designated purposes invalidates the warranty.
- Tefcold reserves the right to request engineer's diagnosis reports before supplying parts if applicable.
- The serial number of the unit at fault must be supplied for warranty to be implemented.
- We reserve the right to collect faulty parts for assessment if applicable.
- We cannot guarantee the operational performance of the case if it is placed in an environment that is outside of its design parameters as described in Section 1.

Should additional Labour Warranty be purchased the cover is as per above, apart from the following additional exceptions which are not considered part of any extended warranty and will be invoiced on a chargeable basis.

- No fault found
- General misuse & abuse
- Site issues including, cabinet locations such as, against open door, excessive solar gain or rear case spacers not fitted
- Lack of general cleaning and maintenance of the product
- Damage caused by the customer moving the product within the premises or another location
- Blocked drains caused by debris
- Incorrect use of extension socket or incorrect power source
- Following a repair by an unauthorised party

## 4. Controls

### How to Use “CAREL PJEZC Temperature Controller”

#### 4.1.1 General Appearance



#### 4.1.2 Introduction & General Descriptions

Easy is electronic microprocessor controller with LED display, developed for the management of refrigerating units, display cabinets and showcases. The structure of the parameters has been enhanced with new functions for more dynamic and effective management of the temperature control and defrost. The most complete solution for low temperature ventilated units, with three relays for complete control of the compressor, fan and defrost functions.

#### 4.1.3 Display

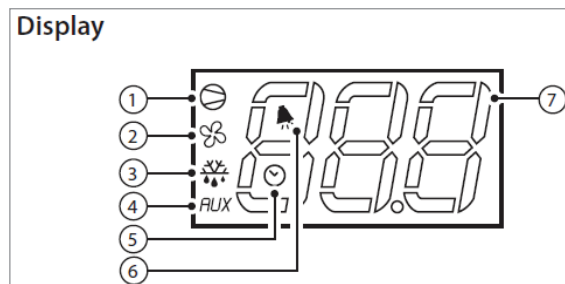

but. no.	function	normal operation			start up
		ON	OFF	flash	
1	compressor	on	off	call	ON
2	fan	on	off	call	ON
3	defrost	on	off	call	ON
4	auxiliary output (AUX)	output active	output not active	-	ON
5	clock (RTC)	RTC available, enabled (tEN=1) and at least one time band has been set	RTC not available or not enabled (tEN=0) or no time band set		ON (if the clock is fitted)
6	alarm	alarm in progress	no alarm in progress	-	ON
7	digits	three digits with decimal point and range -199 to 999. See parameters /4, /5, /6 for the type of probe displayed, values in °C/°F and decimal point			

#### 4.1.4 Keypad

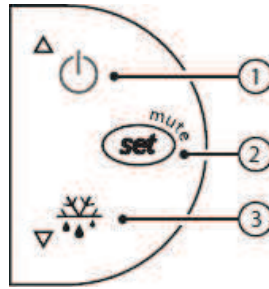

but. no.	normal operation		start up	
	pressing the button alone	pressing with other buttons		
1	more than 3 s: switch ON/OFF	pressed together with 3 activates / deactivates the continuous cycle	-	
2	- 1 s: displays/sets the set point - more than 3 s: accesses the parameter setting menu (enter password 22) - mutes the audible alarm (buzzer)	-	for 1 s RESET current EZY set	pressed together (2 and 3) activate parameter reset procedure
3	more than 3 s: activates / deactivates the defrost	pressed together with 1 activates / deactivates the continuous cycle	for 1 s displays firmware version	

#### 4.1.5 Functions Available from the Keypad

- **ON & OFF the Instrument:**

Switching the instrument ON: press UP for more than 3 s (when pressing the button, the display shows ON).

Switching the instrument OFF: press UP for more than 3 s. The display shows the message “OFF”, alternating with the temperature measured by the set probe.

- **Set Point Setting (Desired Temperature Value)**

The easy, easy compact and easy split devices control the desired temperature (set point) inside the cabinet or cold room directly and dynamically.

**To view and modify the set point:**

- Press SET for 1 s, the set value will start flashing;
- Increase or decrease the value using UP or DOWN;
- Press SET to confirm the new value.

- **Manual Defrost**

Press DOWN for more than 3 s (activated only if the temperature conditions are right, for easy split only if the light output is not set, H1≠4).

#### 4.1.6 Alarms

alarm code	buzzer and alarm relay	LED	alarm description	reset	ENABLE ALARM parameters involved
E0	active	ON	probe 1 error= control	automatic	-
E1	not active	ON	probe 2 error= defrost	automatic	d0= 0 / 1 / 4, F0= 1
E2	not active	ON	probe 3 error= condenser/product	automatic	easy, easy compact [A4=10/11] easy split [A4=13/14]
IA	active	ON	external alarm	automatic	[A4 = 1] [+A7]
dOr	active	ON	open door alarm	automatic	easy, easy compact [A4=7/8][+A7] easy split [A4=7/8/10/11][+A7]
LO	active	ON	low temperature alarm	automatic	[AL] [Ad]
HI	active	ON	high temperature alarm	automatic	[AH] [Ad]
EE	not active	ON	unit parameter error	not possible	-
EF	not active	ON	operating parameter error	manual	-
Ed	not active	ON	defrost ended by timeout	on first defrost ended correctly	[dP] [dt] [d4] [A8]
dF	not active	OFF	defrost running	automatic	[d6=0]
cht	not active	ON	dirty condenser pre-alarm	automatic	easy, easy compact [A4=10] easy split [A4=13]
CHt	active	ON	dirty condenser alarm	manual	easy, easy compact [A4=10] easy split [A4=13]
EtC	not active	ON	clock alarm	by setting the time	if bands are active

#### 4.1.7 Temperature Control

The temperature in the appliance is registered by two temperature sensors which are located in the air flow after the evaporator ( $S_{air}$ ) and on the evaporator (S5) respectively.

#### 4.1.8 Liquid Management

Liquid injection in the evaporator is controlled by capillary tubes.



## 5. Controller Setting Parameters

### .1 CAREL PJEZC (MASTER)

Parameter List	CALLISTO MT CAREL PJEZC		REV00	REV00
Controller	CAREL PJEZC	Unit	Open Fronted	with Door
	Parameters			
PS	Password	-	22	22
St	Set point	°C/°F	-2,0	-0,0
<b>Probe Parameters</b>				
/2	Probe measurement stability	-	1	1
/4	Select probe displayed	-	1	1
/5	Select °C/°F	-	0	0
/6	Disable decimal point	-	0	0
/C1	Probe 1 off set	°C/°F	0	0
/C2	Probe 2 off set	°C/°F	0	0
/C3	Probe 3 off set	°C/°F	0	0
<b>R Control Parameters</b>				
rd	Control differential	°C/°F	1	2
r1	Minimum set point value	°C/°F	-3	-3
r2	Maximum set point value	°C/°F	2	2
r3	Select direct/reverse operation	-	0	0
r4	Night-time set point delta	°C/°F	0	0
<b>C Compressor Parameters</b>				
C0	Compressor and fan start delay on power-up	min.	1	1
C1	Minimum time between consecutive compressor starts	min.	2	2
C2	Minimum compressor off time	min.	2	2
C3	Minimum compressor on time	min.	0	0
C4	Compressor on time with duty setting	min.	100	100
Cc	Continuous cycle duration	h	4	4
C6	Temperature alarm bypass after continuous cycle	h	0	0
<b>D Defrost Parameters</b>				
d0	Type of defrost 0=heater, 1=hot gas, 2=heater on time, 3=hot gas on time, 4=heating time and temperature on the value off	-	4	4
dl	Interval between defrosts	h/min.	3	3
dt	End defrost temperature set point/defrost temperature threshold with temperature control	°C/°F	8	8

<b>dp</b>	Maximum defrost duration	min./s	30	30
<b>d4</b>	Defrost when switching the instrument on	-	0	0
<b>d5</b>	Defrost delay on power-up or when enabled by digital input	min.	0	0
<b>d6</b>	Freeze control temperature display during defrost	-	1	1
<b>dd</b>	Dripping time	min.	0	0
<b>d8</b>	Alarm bypass time after defrost	h	1	1
<b>d9</b>	Defrost priority over compressor protectors	-	0	0
<b>d/</b>	Defrost probe reading (2)	°C/°F	-	-
<b>dc</b>	Time base	-	0	0
<b>A</b>	<b>Alarm Parameters</b>			
<b>A0</b>	Alarm and fan temperature differential	°C/°F	0	0
<b>A1</b>	Absolute/relative temperature for low temperature alarm	°C/°F	-8	-8
<b>Ah</b>	Absolute/relative temperature for high temperature alarm	°C/°F	20	20
<b>Ad</b>	Temperature alarm delay	min.	15	15
<b>A4</b>	3rd input configuration: 0=multifunction input disabled, 1=external alarm, 2=Enable defrost, 3=Start defrost on closing, 4=Curtain switch and night-time operation, 5=Remote ON – OFF, 6=Direct operation of AUX output with H1=3, 7=Door switch with evaporator fans off, 8=Door switch with evaporator fan and compressor off, 9=Direct/reverse operating mode r3= 0 specifies the activation of the defrost control, 10=Probe for dirty condenser alarm, 11=Product probe	-	0	0
<b>A7</b>	Digital input alarm delay	min.	30	30
<b>A8</b>	Enable alarm “Ed” (end defrost by timeout)	-	0	0
<b>Ac</b>	Set point dirty condenser alarm	°C/°F	55	55
<b>Ae</b>	Dirty condenser alarm differential temperature	°C/°F	10	10
<b>Acd</b>	Dirty condenser alarm delay	min.	0	0
<b>F</b>	<b>Fan Parameters</b>			
<b>F0</b>	Enable evaporator fan control	-	1	1
<b>F1</b>	Evaporator fan control set point	°C/°F	50	50
<b>F2</b>	Stop evaporator fan if compressor off	-	0	0
<b>F3</b>	Evaporator fan status during defrost	-	0	0
<b>Fd</b>	Post-dripping time	min.	0	0
<b>H</b>	<b>Other Settings</b>			
<b>H0</b>	Serial address	-	0	0

H1	AUX output configuration: 0=no function associated with the output, 1=alarm output: norm. Energised, 2=AUX output related to Dig. in.A4 = 6/7/8 Dig. In. OPEN = AUX de-energised, Dig. in. CLOSED = AUX energised + LED "AUX" display"	-	0	0
H2	Enable keypad (0=keypad disabled,1=keypad enabled,2=keypad enabled except for ON/OFF)	-	2	2
H4	Disable buzzer (0=buzzer enable,1=buzzer disable)	-	0	0
H5	ID code (read-only)	-	-1	0
EZY	Rapid parameter set selection	-	4	4

## .2 Common Defrost



- If the multiplexing cabinet is operated as slave module depending on the master module, parameter A4 must be set as 3 (factory set). Parameter "A4 = 3" means defrost start (pulse-pressure) via the signal received from master module. This maintain simultaneous defrosting in the cabinets on the same multiplexing line.
- Connect P3 connector of master cabinet to the P2 connector of slave cabinet to initiate common defrost (see wiring diagrams).
- Master cabinet initiate defrost for both cabinets if required connection is made properly.
- If master cabinet terminates defrost regarding to parameters "dt" or "dp", slave cabinet also terminates if required connection is made properly.
- Slave cabinet terminates defrost if parameter "dt" reaches defrost end temperature without waiting a signal from master cabinet.

# 6. Wiring Diagrams

## .1 TEFCOLD EXPRESS EX125C OPEN FRONTED

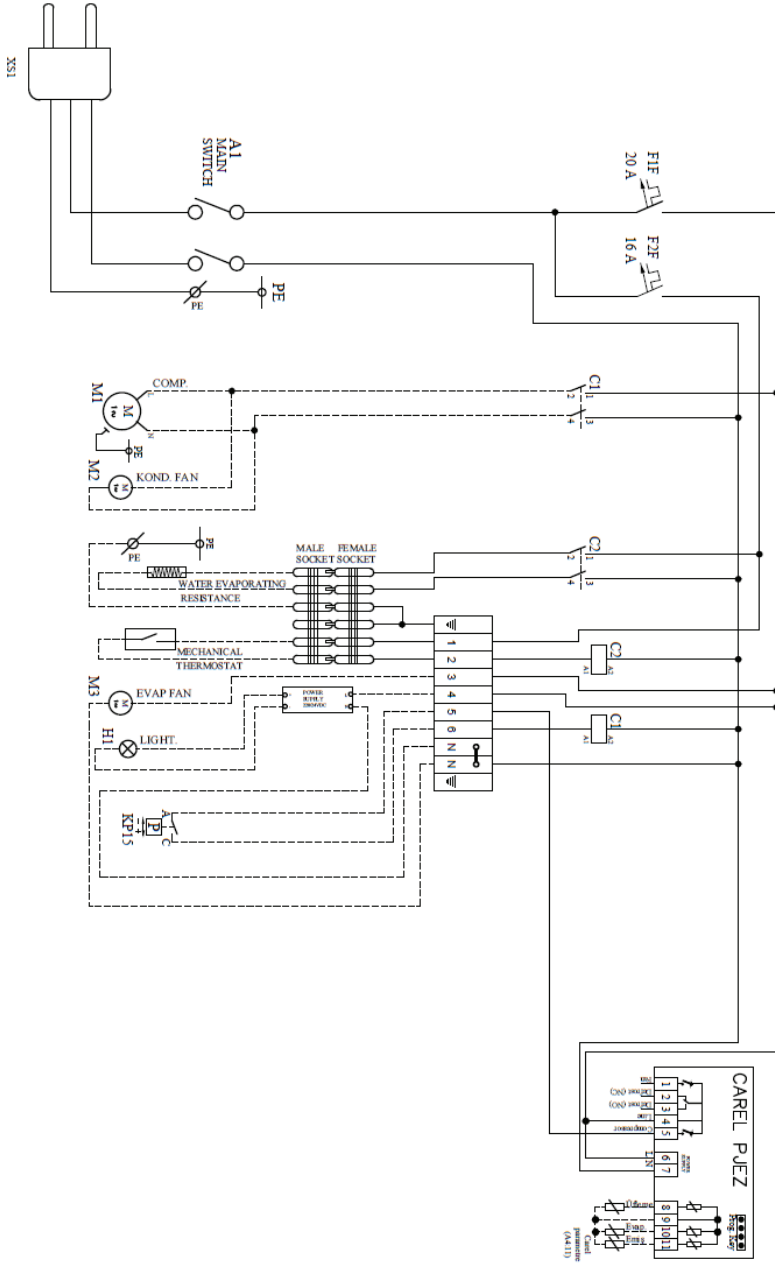

## .2 TEFCOLD EXPRESS EX187C OPEN FRONTED

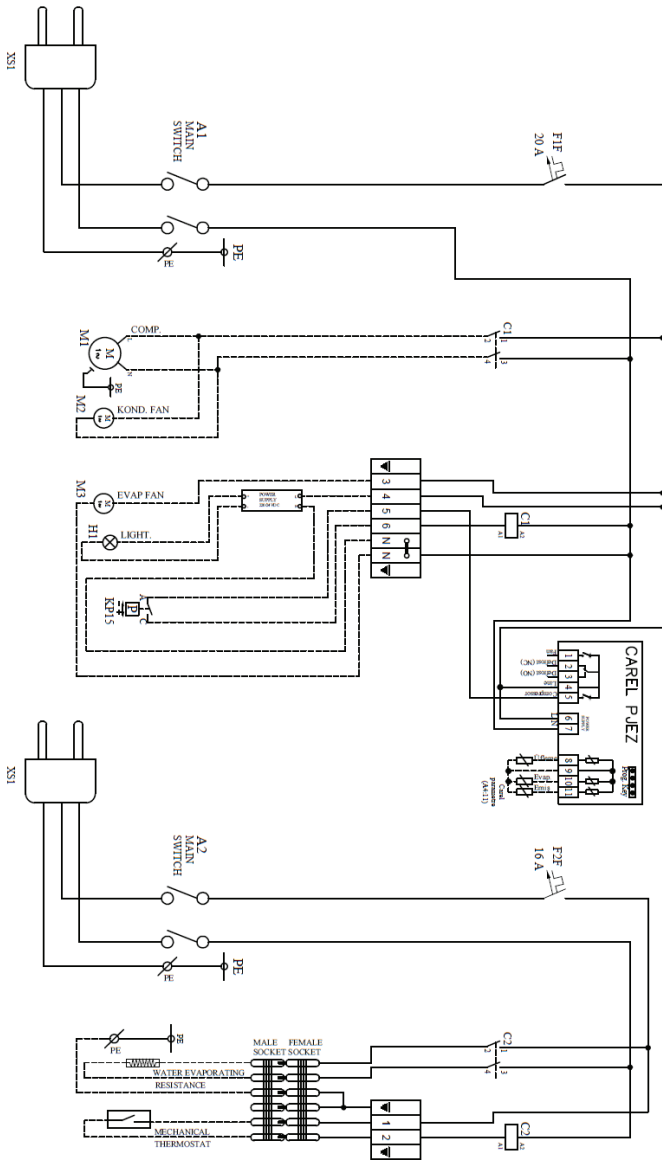

### .3 TEFCOLD EXPRESS EX250C OPEN FRONTED

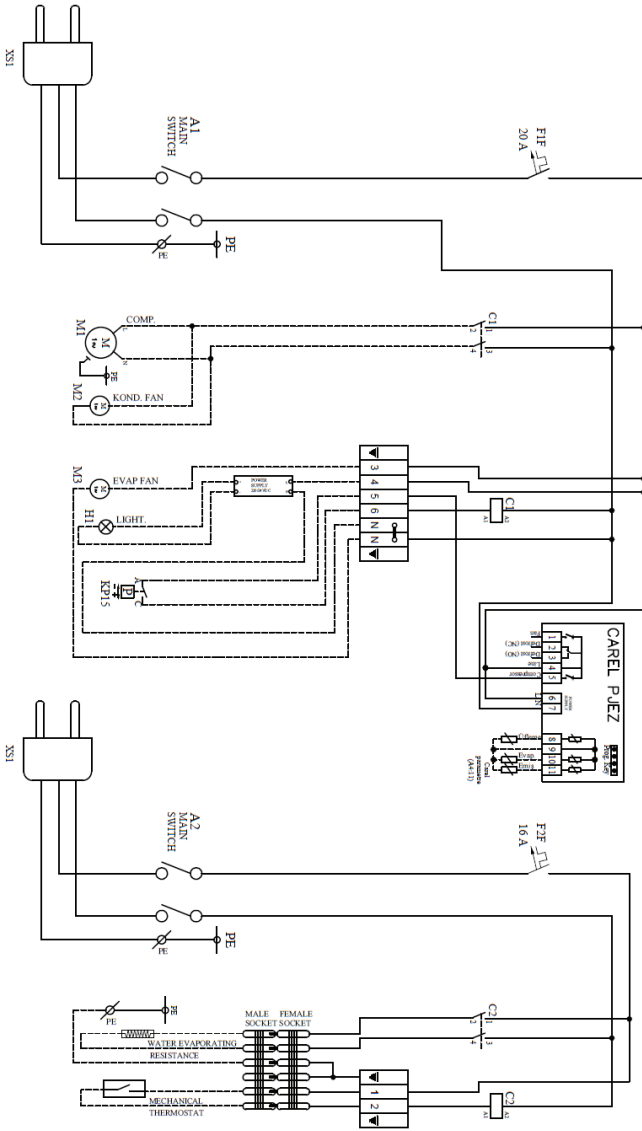

# .4 TEFCOLD EXPRESS EX125CD WITH DOOR

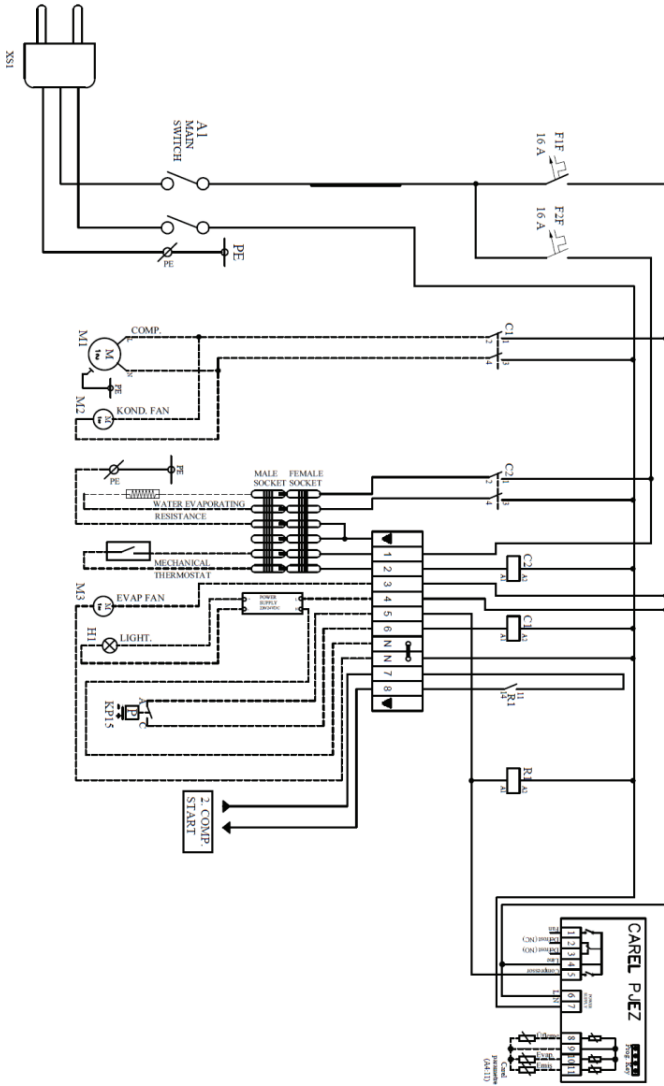

# .5 TEFCOLD EXPRESS EX187CD WITH DOOR

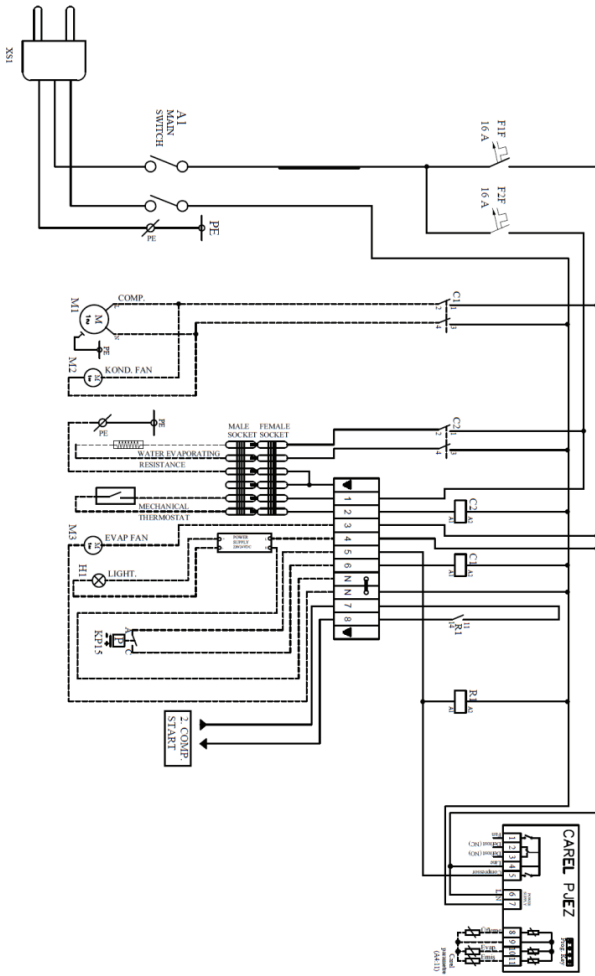



# .6 TEFOLD EXPRESS EX250CD WITH DOOR

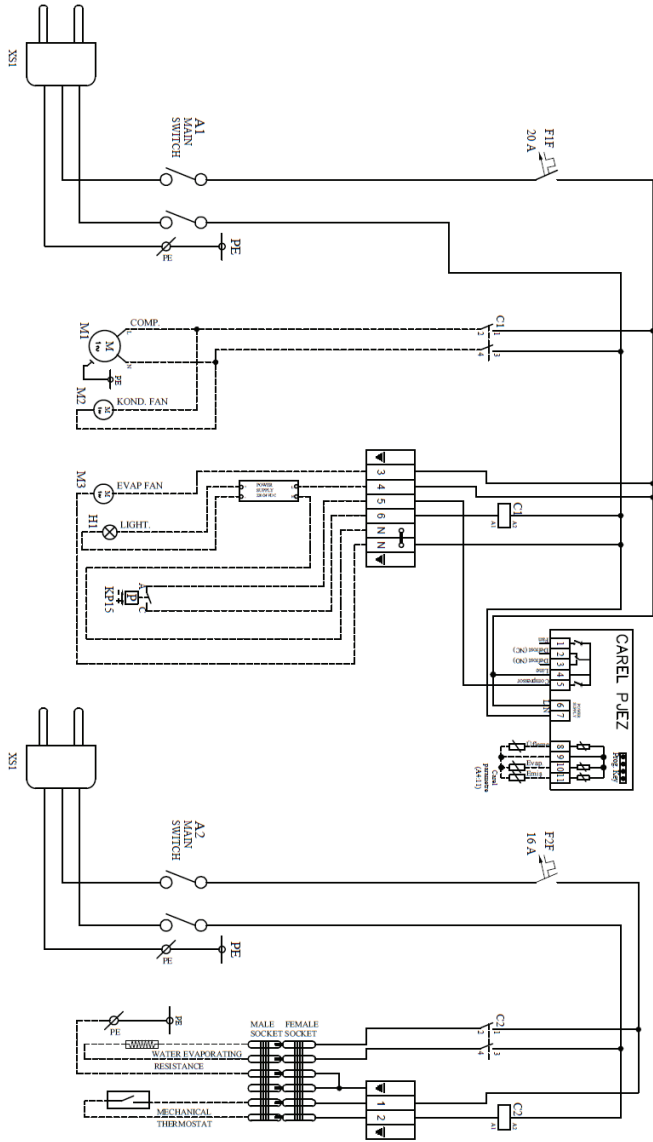

## 7. Cabinet Technical Details

In this manual all dimensions of technical drawings are given in millimetres (mm).

### Side Elevations

TEFCOLD EXPRESS Vertical Refrigerated Display Cabinets (multi decks integral) offer ideal solutions with their length options for display and sale of delicatessen, ready meals and prepacked meat products.

TEFCOLD EXPRESS is a dynamic model with its stylish lines which surrounds and an ideal choice for all types of applications from hypermarkets to express stores and convenience stores.

TEFCOLD EXPRESS is designed to make the products highly visible and easily accessible to the customer.

#### 7.1.1 Open Fronted CROSS SECTION

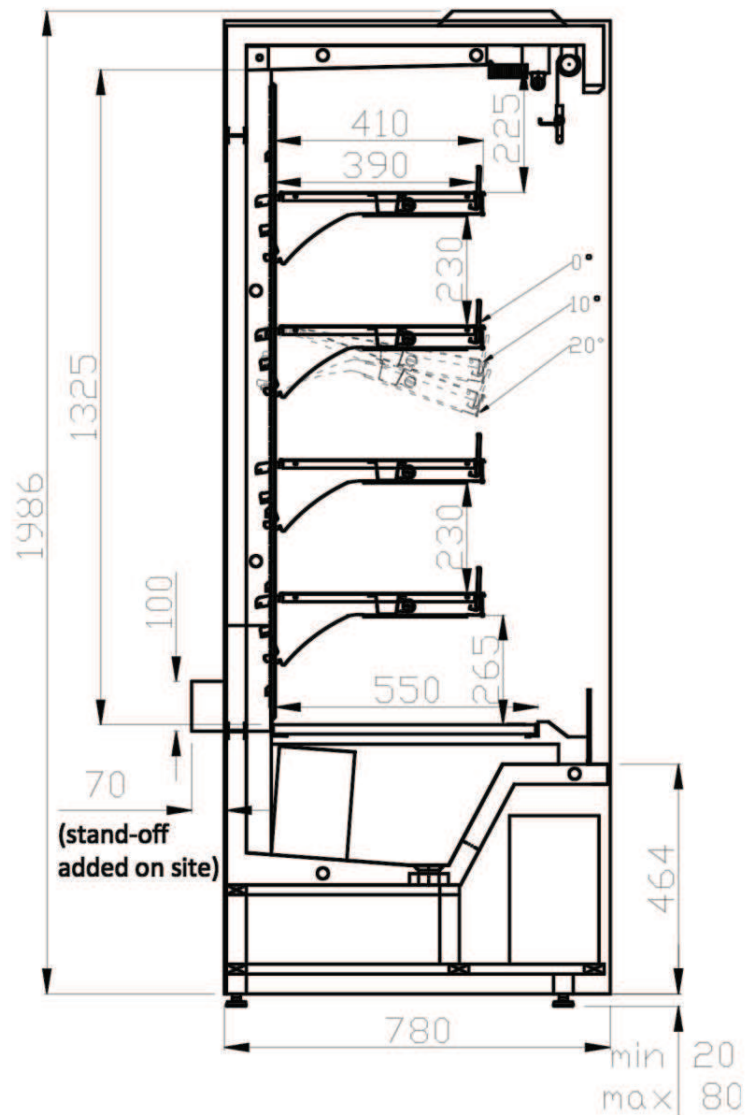

### 7.1.2 Double Pane Glazing Door (Hinged) CROSS SECTION

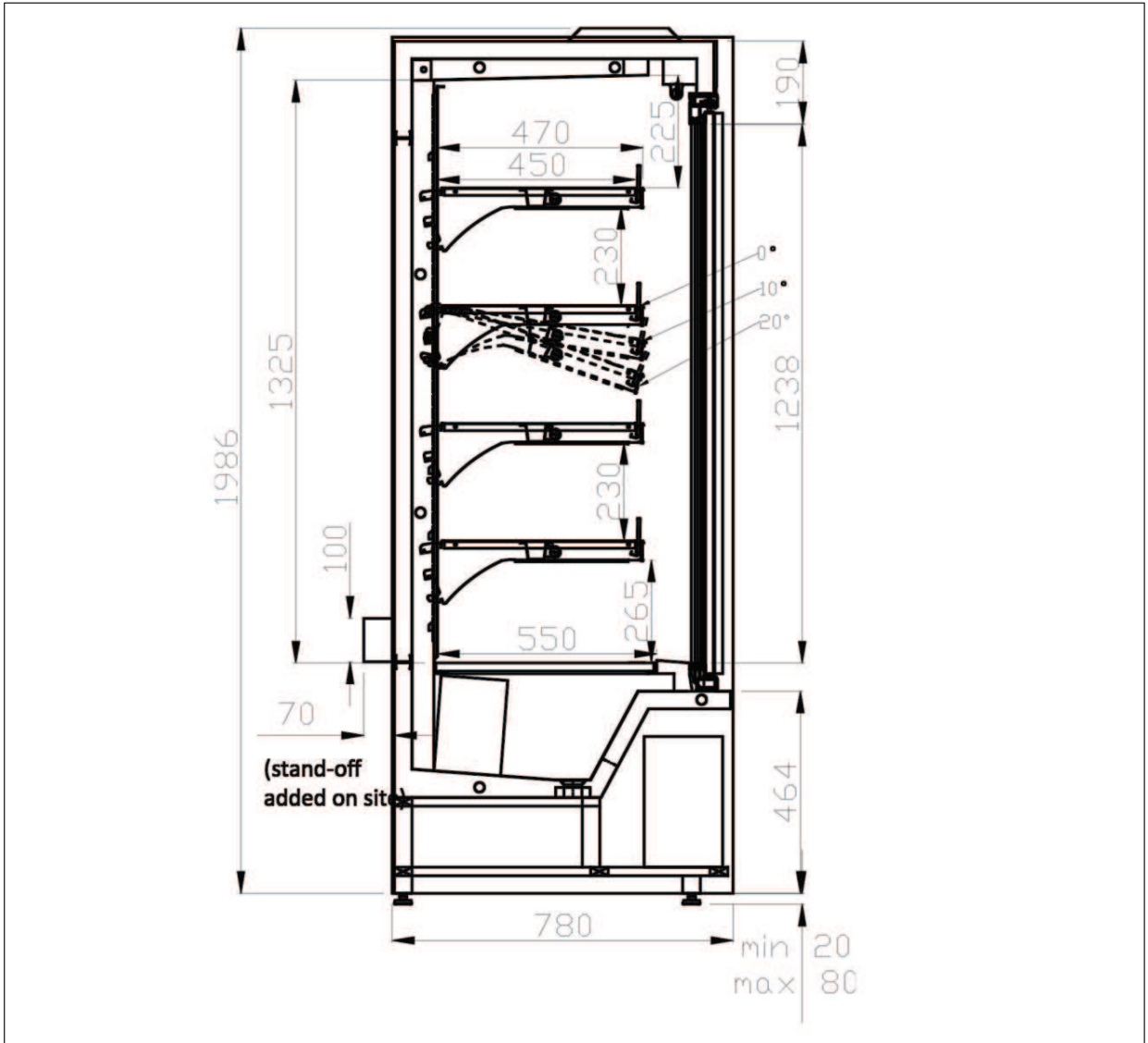

### 7.1.3 Case Lengths

Model	Model	Nominal Length	Length Including Endwalls
EX125C	EX125CD	1250mm	1330mm
EX187C	EX187CD	1875mm	1955mm
EX250C	EX250CD	2500mm	2580mm

## 7.2 Cabinet Data Plate Descriptions

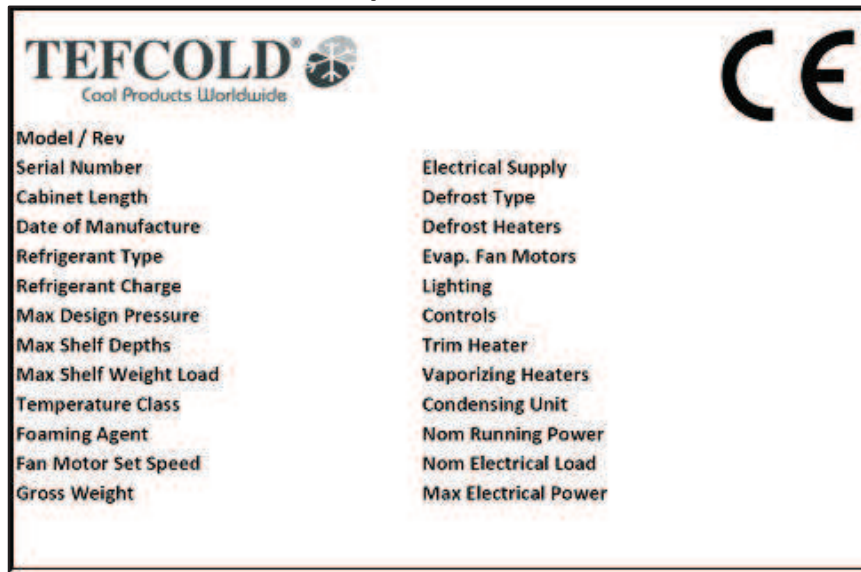

No	Description	unit
Model / Rev	Cabinet Model Name/Reference & Revision	-
Serial Number	Cabinet Serial Number	-
Cabinet Length	Cabinet Length without End Wall(s)	mm
Date of Manufacture	Production Month / Year	-
Refrigerant Type	Type of Refrigerant	-
Refrigerant Charge	Refrigerant Charging Amount	g
Max Design Pressure	Refrigeration Design Operating Pressure	bar
Max Shelf Depths	Maximum Allowable Shelf Depths	mm
Max Shelf Weight Load	Maximum Allowable Shelf Weight Loadings	kg
Temperature Class	Classification of Product Temperature in Compliance with EN ISO 23953-2	-
Foaming Agent	Insulation Foaming Agent	-
Fan Motor Set Speed	Evaporator Fan Motor Speed	rpm
Gross Weight	Maximum Weight of Cabinet for Transportation	kg
Electrical Supply	Electrical Supply Requirement (Volts/phase/Amps)	-
Defrost Type	Defrost Method	-
Defrost Heaters	Defrost Heater(s) Power Consumption	Watt
Evap. Fan Motors	Evaporator Fan Motors Power Consumption	Watt
Lighting	Lighting Fixtures Power Consumption	Watt

Controls	Control Equipment Power Consumption	Watt
Trim Heater	Trim Heaters Power Consumption	Watt
Vaporizing Heaters	Condense Water Vaporizing Heaters Power Consumption	Watt
Condensing Unit	Condensing Unit Equipment Total Power Consumption	Watt
Nom Running Power	Nominal Power Consumption	Watt
Nom Electrical Load	Nominal Electrical Load	amps
Max Electrical Power	Maximum Power Consumption	Watt

### 7.3 Refrigeration

Cabinet Type	Refrigeration Type	Refrigerants
<b>TEFCOLD EXPRESS</b>	Integral Incorporated Condensing Unit	R449A

Designation of refrigerated display cabinet families

Application	Temperature Positive	
To be used for	Chilled foodstuffs	
Vertical	Chilled, multi-deck	VC2
R	Remote condensing unit	
I	Incorporated condensing unit	
A	Assisted service	
S	Self-service	
H	Horizontal	
V	Vertical	
Y	Combined	
C	Chilled	
F	Frozen	
M	Multi-temperature	

TEFCOLD integral multi-deck cabinets are primarily in self-service.

### 7.4 Noise Breakout

The A-weighted sound power level of the cabinet when measured in isolation from other units, with shelves fitted is lower than 70 dB(A).

## 8 Service and Maintenance



All servicing of the display cabinet refrigeration and electrical systems should be undertaken by qualified person(s) having suitable knowledge of electrical and refrigeration systems.

Always electrically isolate the cabinet before carrying out any work that may affect or expose electrical components or moving parts (e.g.: fan blades).

### 8.1 Access to fans

For access to fans, remove deck panels.

If removing fan baffle assembly, remove screws at top of fan baffle and then lift it out using the lifting rings on the baffle. Place near the cabinet ensuring there is no strain placed on connecting cables.

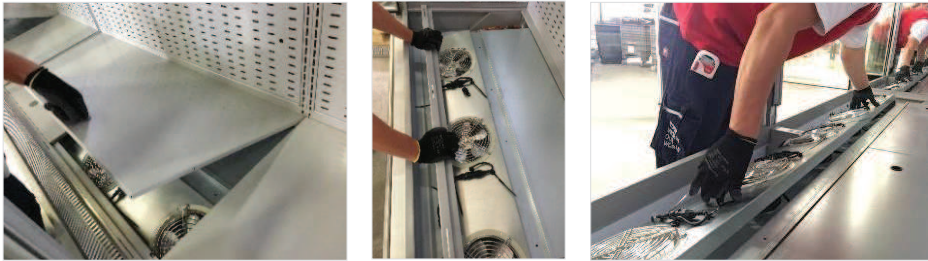

### 8.2 Access to drainage outlets

In order to access cabinet inner drainage, remove deck trays, drainage outlet can be seen.



This drainage outlet pipe is placed into the Condensed Water Tray. Be sure that outlet of this drainage is placed into tray. Periodically check water level of tray.

### 8.3 Access to cabinet electrics and controls

When working inside the electrics tray the electrical power supply must be isolated elsewhere as there are live wires feeding into the tray. The tray-mounted switch does not isolate the incoming supply.

The electrical box is located bottom of the cabinet, just behind the front fascia panel.



The power connections are shown on the cabinet's power supply board on the electric schemes. The electric connections must only be made by authorised personnel. The power supply size is shown on the label on the cabinet, it is also given on the electrical schematics.

## 8.4 Condensing Unit Access

If servicing is required only qualified refrigeration persons may carry out the work.

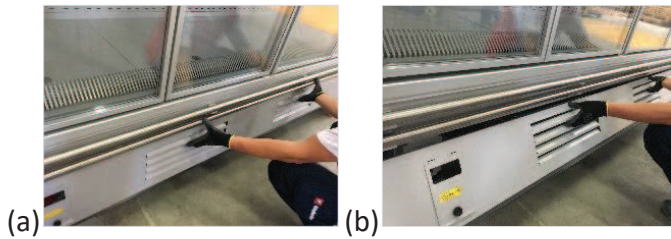

(a) - (b) Pull up the front lift off panel and then pull toward yourself. This will reveal the condenser, compressor and high & low pressure switches, all accessed from the front.

Please note the air cooled condenser draws air in through the ventilated front panel and rejects the heat through the condenser and downward towards the floor, this arrangement should also help keep the condenser cleaner.



All servicing of the display cabinet, refrigeration and electrical systems should be undertaken by qualified service persons having suitable knowledge of electrical and refrigeration systems.

## 8.5 Refrigeration, Electrical and Drainage Connections

### 8.5.1 Refrigeration



There is one reciprocating type of compressor in TEFOCLD EXPRESS EX125C/EX187C/EX125CD EX187CD/EX250CD cabinet (single circuit).

There are two reciprocating compressors in TEFCOLD EXPRESS EX250C cabinets

TEFCOLD EXPRESS cabinets are delivered refrigerants pre-charged at factory. Below instructions are for servicing only.

Follow instructions below before operation:

- Installation of the refrigeration and electrical components must be performed only by a refrigeration engineer or licensed electrician.
- Be sure that electric main supply is switched off. Avoid any sparks generation.
- Evacuate the Nitrogen (N) holding charge (approx. 3bar) carefully then evacuate the systems at least 45 minutes.
- Charge Refrigerant into the system.
- Plug -in the cabinet and run until setting temperature.
- Do not add any oil to the Compressor.

## Installation Instructions with Reciprocating Compressors

### System Evacuation

It is recommended to evacuate system through liquid line and suction line at the same time. Must assure no air and water get



Above visuals are for example usage only

Never start the compressor while it is under deep vacuum, otherwise the compressor will be damaged.

Never use the compressor to evacuate the system. Use a high vacuum pump specially design for that purpose.

into the system while evacuating.

### System Charging

- a. After evacuating, ensure system holds vacuum for 30 minutes, charge refrigerant through liquid line (NOT suction line). Refrigerant scales MUST be used on a critical charge system. Then start the compressor and run more than 3 minutes for the purpose of making each part of the compressor fully lubrication.
- b. If refrigerant insufficient and no more refrigerant will enter system, start the compressor and charge refrigerant through the suction line by throttling the liquid. This is done by restricting the flow of the liquid by controlling the gauge valve to ensure is not passed through the compressor. Never run the compressor for a long time, in case refrigerant is insufficient or leaking. Otherwise the compressor will be overheated and damaged.
- c. Refrigerant charge must be strictly adhered to section 8.6.2

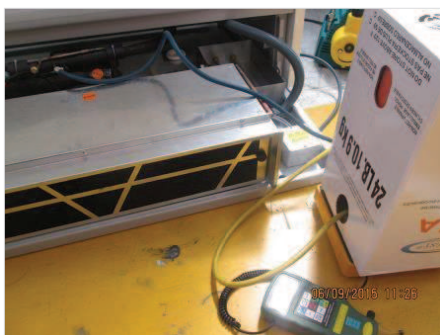

Above visuals are for example usage only



## 8.5.2 Refrigerant Charge Limits

Cabinet Length		mm	1250	1875	2500
Refrigerant Type		-	R449A		
Gas Charges	TEFCOLD EXPRESS EXC – open fronted	grams	1350	1750	2 x 1500
	TEFCOLD EXPRESS EXCD – double pane door		1100	1300	1500

## 8.5.3 Electricity



Electric connections must only be made by qualified personnel, according to safety norms. Make sure that the power supply voltage is the same as that indicated on the nameplate. 230V/1Ph/50Hz voltage variations on the supply line should not exceed +/-6% of the nominal value.

**IMPORTANT:** Make sure that the electrical box cover is in place and that the power supply cords are fitted with the appropriate cable clamps.

## 8.5.4 Plugs



If the supply cord is damaged, it must be replaced by the manufacturer, its

Electrical Data	Model	Length	Condensing Units per case	Power supply per case	Supply	Visual
	EX125C	1250mm	1	1	230V/1PH/50HZ 13 Amp	
	EX187C	1875mm	1	2		
	EX250C	2500mm	2	2		

Electrical Data	Model	Length	Condensing Units per case	Power supply per case	Supply	Visual
	EX125CD	1250mm	1	1	230V/1PH/50HZ 13 Amp	
	EX187CD	1875mm	1	1		
	EX250CD	2500mm	1	1		

## 8.5.5 Cabinet Lighting

TEFCOLD EXPRESS EXC cabinets have canopy LED lighting and TEFCOLD EXPRESS EXCD Door cases have Door and canopy LED lighting that helps to highlight merchandises placed in it.

Lights are controlled via manual lighting switch. Electric box, main isolator and light switches are located on the bottom of the cabinet.

## 9 Instructions for Delivery

### 9.1 Transportation

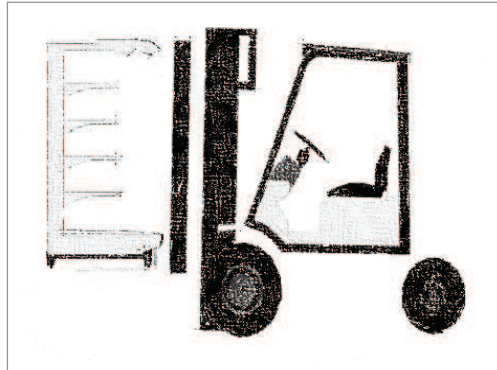

TEFCOLD Refrigeration manufactures its refrigerated cabinets suitable to be lifted using a suitable forklift. Care must be taken to place the forklift forks into appropriate areas underneath the cabinet.

Centre of gravity of the cabinets are not in the centre exactly and slightly close to the rear of the cabinets. This makes cabinets unbalanced.

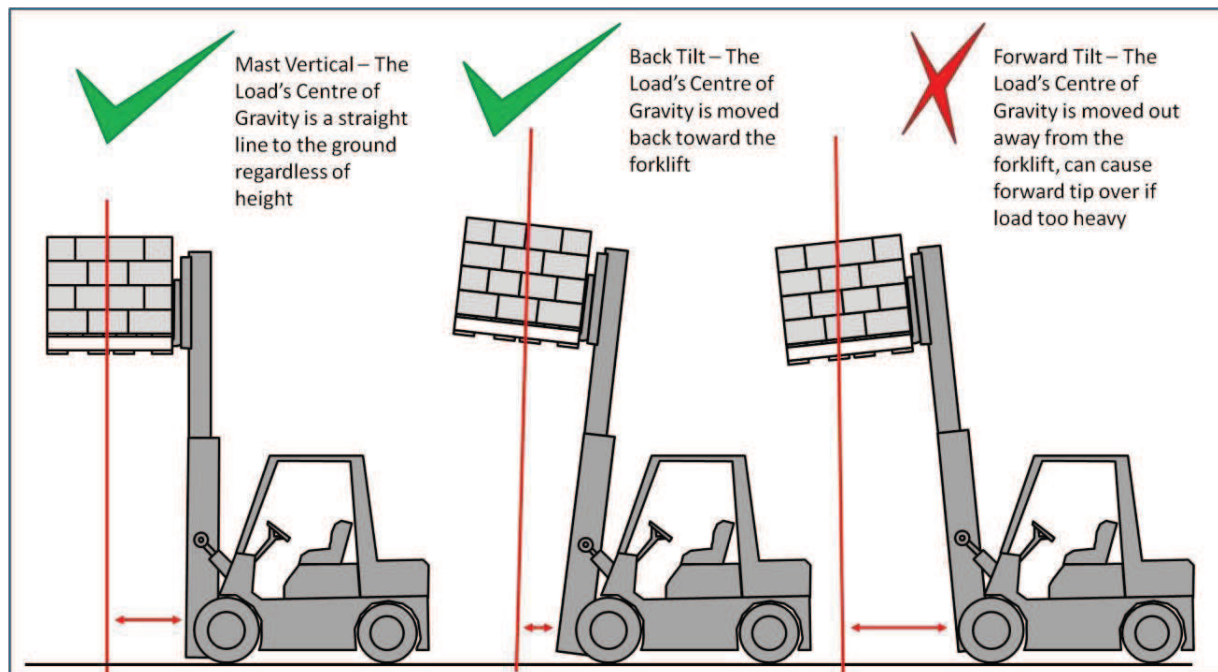

TEFCOLD undertakes no responsibility for damage caused by inconvenient transportation.

## 10 Installation

### 10.1 Unpacking

All cases have a wooden crate plus are wrapped with plastic stretch films.

The installer will need to remove the wooden crate prior to installation.

Remove the packaging only after having positioned the unit.

- a. To examine the cabinet carefully against to probable damages which are occurred during transportation.
- b. In case of the cabinet is non-damaged, to remove the cabinet and transport to the assembly section. At least two person must escort to the cabinet during transportation.
- c. To get out of internal parts from the cabinet and keep them in secure area until reusing. To collect and classify packing materials of the cabinet and re-cycle them in proper way.

### 10.2 Minimum Clearances for Placing the Cabinet.

Cabinet Dimension A, Can be 70mm when the supplied rear spacer is fitted.

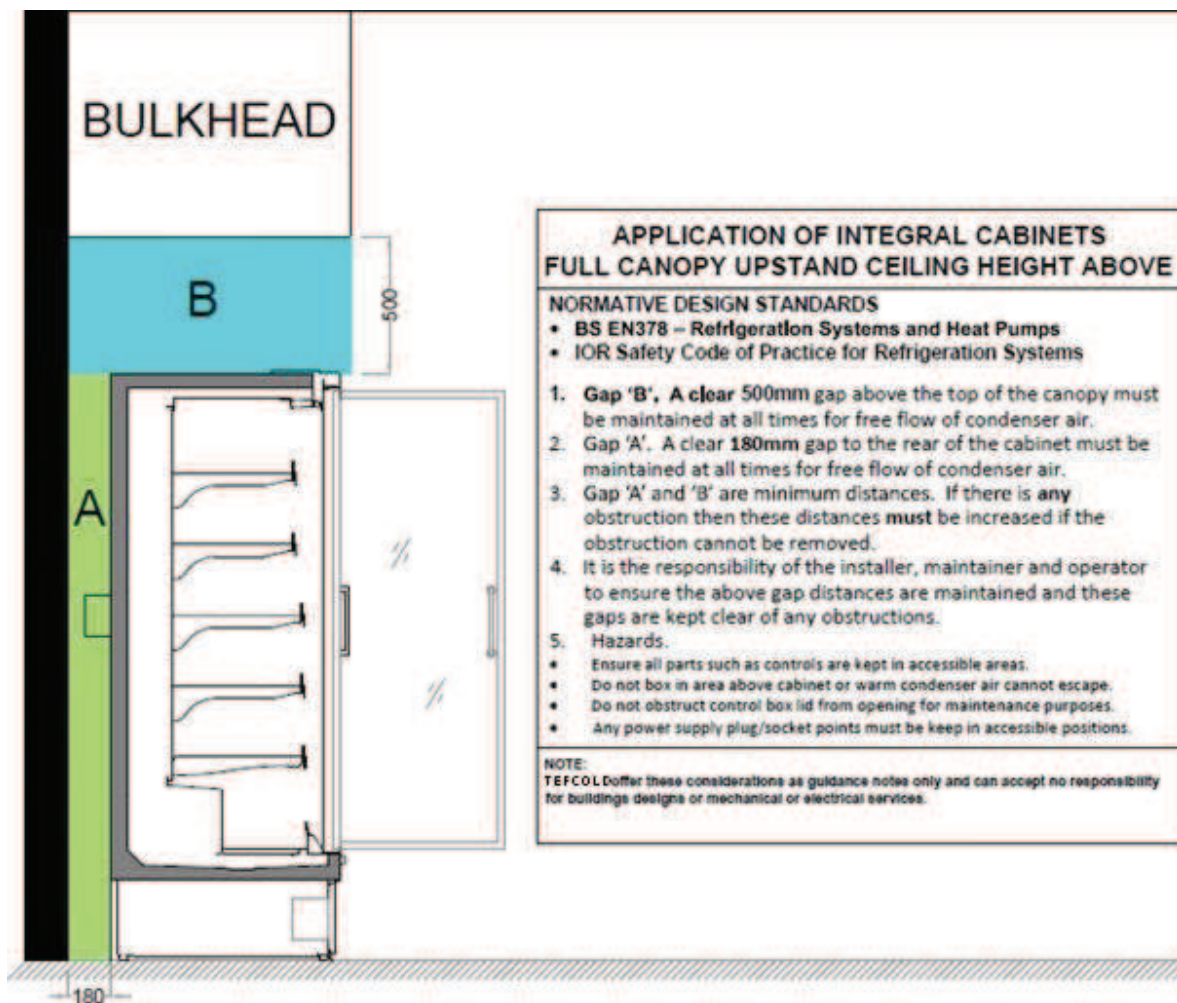

## 10.3 Removing from Wooden Pallet

Remove packages of the cabinet



Unscrew retaining screws wood from the wooden pallet with using proper instrument



Case can now be lifted off using the correct lifting equipment.  
Follow the foot adjustment to level case

## 10.4 Levelling

To ensure the cabinet is installed level and square, the following should be done after removing the packaging. The base plate at the bottom of the cabinet is removed. By screwing the adjustable feet at the right and left, the height of the cabinet is adjusted.

- The feet can be adjusted  $\pm 15\text{mm}$  using simple tools. For adjustment a 32mm wrench is required.

**Left /right foot adjustment**





- **Levelling process should be done every time the cabinet is moved.**
- Adjustment of the rear feet is important.
- Cabinet must be aligned very smooth as absolutely straight without any difference between heights of front and rear of the cabinet.



- 
- The spirit level is located vertically as seen above pictures. Bubble of spirit level must be positioned in the middle if rear, front and middle feet are levelled correctly.
- 



- Or, the spirit level is located horizontally as seen above pictures. Bubble of spirit level must be positioned in the middle if rear and front feet are levelled correctly.



- **Cabinet levelling should be checked refer to the spirit level which is positioned vertically and horizontally.**

#### 10.4 Levelling and Door Alignment

- If the bubble of spirit level is positioned on right hand side, it means front foot is higher than rear foot. To wind down the rear foot with using proper wrench while monitoring the spirit level bubble.

**As a result of this misalignment, right hand door is higher than left hand door.**

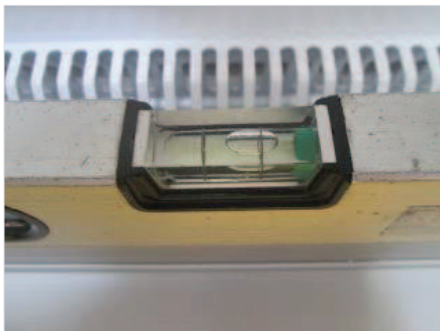

- If the bubble of spirit level is positioned on left hand side, it means rear foot is higher than front foot. To wind down the front foot with using proper wrench while monitoring the spirit level bubble.

**As a result of this misalignment, left hand door is higher than right hand door.**



**Foot adjustment and levelling of the cabinet is very important application and must be done in a correct way.**

### **10.5 Assembly of Wall Spacers**

The wall spacers are supplied in a separate bag located inside the case and require fitting on site.

Wall spacers are used to maintain proper gaps between the cabinet and construction wall for dispatching the air from condensing unit.



**These wall spacers must NOT BE removed. Removing them or not fitting them could invalidate the warranty.**

Wall spacer is 70mm and requires fixing to the rear of the case prior to positioning. Without this the case may not be able to reject the heat produced during the refrigeration cycle.

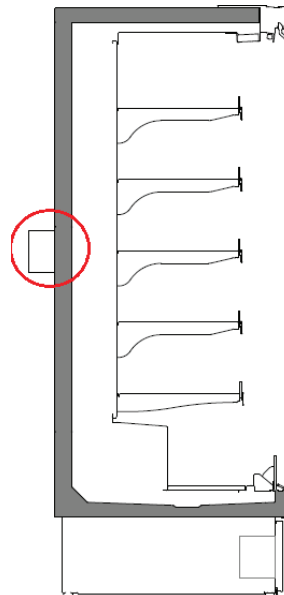

## 10.6 Shelf Profiling & Fitting of Accessories

The the EXCD range of glass door cases will comewith the doors strapped to prevent movement during transporatation. These need to be cut to allow access into the caes



Both EXC open caes and EXCD glass door case are shipped with the brackets, shlef strenghting bar and shelves fitted and again are retained by straps. Remove the straps.



In the base of the case wrapped will be, ticket strip, glass front risers and for EXC open cases front weir glass



Prior to adjusting shelves it is advisable to fit the ticket strips to the shelf front edge. To do this take place the top part of the ticket strip, push and clip around the bottom edge. If the tickets strip is cold it may take several attempts to fit.



Then place shelves on the brackets. For every shelf, two shelf brackets are delivered. Distance between two shelves can be maintained according to the products that will be placed with 25 mm slot pitch.

#### Assembly of Shelf (Product) Risers



10.6.1 Place the shelf risers and fit between the ticket strip and shelf edge.

- ✓ Shelf risers are galss and wrapped please take care when removing protective wrapping.

Shelf position and maximum weight loading per shelf

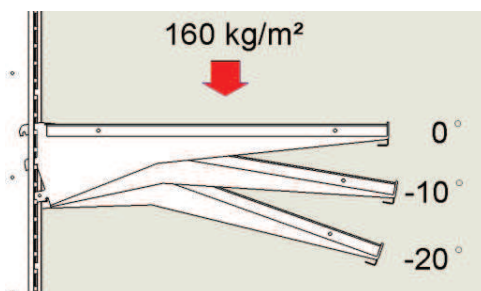

Do not exceed the loading capacity on pans and shelves. (160 kg / m<sup>2</sup>)

In the devices with shelves, the shelves can be used at different angles depending on the device type. (0 °, 10 °, 20 °)

Leave a minimum of 30mm space for air circulation between the upper shelf and the product in the devices with shelves.

Do not load in a way that prevents the cold air flow. (e.g., front suction zone)



For EXC Open case fit front galss weir risers. Remove rsier from protective wrapping and slide in between the stainless steel reatiners left and riser and pus firm between case front and air return grill



## 10.7 Power Supply

**All power supply cables must be correctly sized by competent personnel, fitted correctly and be manufactured from materials suitable for the application.**

Cable connection points must be properly isolated in order to prevent sparks. All electrical equipment must be fitted with adequate Earth protection cables and all cables must be suitably identified.



**Before starting installation of electricity, be sure that main switch is OFF or main supply is DISCONNECTED.**

Electric box and main isolator switch is located on the bottom of the cabinet.

Do not need to remove front fascia panel in order to reach the controller and the isolator switch.

### **Prolonged Cabinet Switch-Off**

- Remove the product contained in the cabinet and put it immediately in a relevant cold storage container in order to guarantee correct preservation.
- Open the cabinet and wait for it to reach room temperature and then clean it.
- If doors fitted leave open by 2-3 cm so as to guarantee circulation of the air and prevent the formation of mould and bad smells inside the cabinet.

## 11.Dismantling and Disposal

During normal operation, the appliance does not generate any environmental contamination. At the end of its life cycle, or if it is necessary to proceed to permanent decommissioning.

To protect environment, please separate the parts and materials composing the display case in accordance with the waste disposal provisions in force in your country, so that they can be properly disposed of or recycled.



All recyclable materials and waste should be processed and recycled by professionals, in compliance with the laws in the country in question.

The company responsible for recycling the materials should be registered and certified as a waste disposal service in accordance with the country in question.

## 12.Maintenance

The following outlines the minimum requirements for regular maintenance. The Staff in charge of the appliance must control and respect the expiry dates for maintenance, given in the table below, calling the authorised Technical After-sales assistance when indicated.

OPERATION	FREQUENCY			Authorised Personnel
	I f R e q u i r e d	3 M o n t h s	A n n u a l	
Cleaning exterior surfaces	+			by Store Staff
Cleaning interior surfaces without use of tools	+			
Cleaning condense water tray		+		
Demerchandise and electrically isolate the cabinet		+		by Qualified Maintenance Technician  
Remove the shelves, base and rear panels and clean		+		
Clean and flush the cabinet base, evaporator coil and drains		+		
Clean condenser	+	+		
Remove and clean the honeycomb		+		
Refrigerant leak check all pipework, joints and components and check there are no rubbing parts		+		
Re-assemble cabinet		+		
Check that the evaporator fans spin freely and there is no slack in the bearings		+		
Visually check wiring for damage		+		
Check power cable and plug		+		
Visually check flexible copper pipeworks for damage		+		
Visually check insulation of copper pipeworks for damage			+	
Re-start the cabinet and ensure that the evaporator and condenser fans are all working		+		
Check that all door trim heaters are working (if any)		+		
Check that all LED lighting fixtures and light switch are working properly	+	+		
Force the cabinet to defrost to ensure that evaporator is clean after defrost is terminated		+		
Full cabinet deep clean			+	
Check the fans and motors are of the correct type and run at the correct speed			+	
Check the cabinet controller setpoints correct, including; temperature control set points, defrost frequency, duration and termination settings			+	

TEFCOLD A/S Industrivej 25 8800 Denmark T: +45 8660 1933 E: [info@tefcold.dk](mailto:info@tefcold.dk)  
 TEFCOLD West Meadow Rise Castle Donington Derby DE 74 2HL T: 01332 850090 E: [trade.sales@interlevin.co.uk](mailto:trade.sales@interlevin.co.uk)