

Hand Blender

Instruction Manual & Guarantee

Dualit®

Since 1945

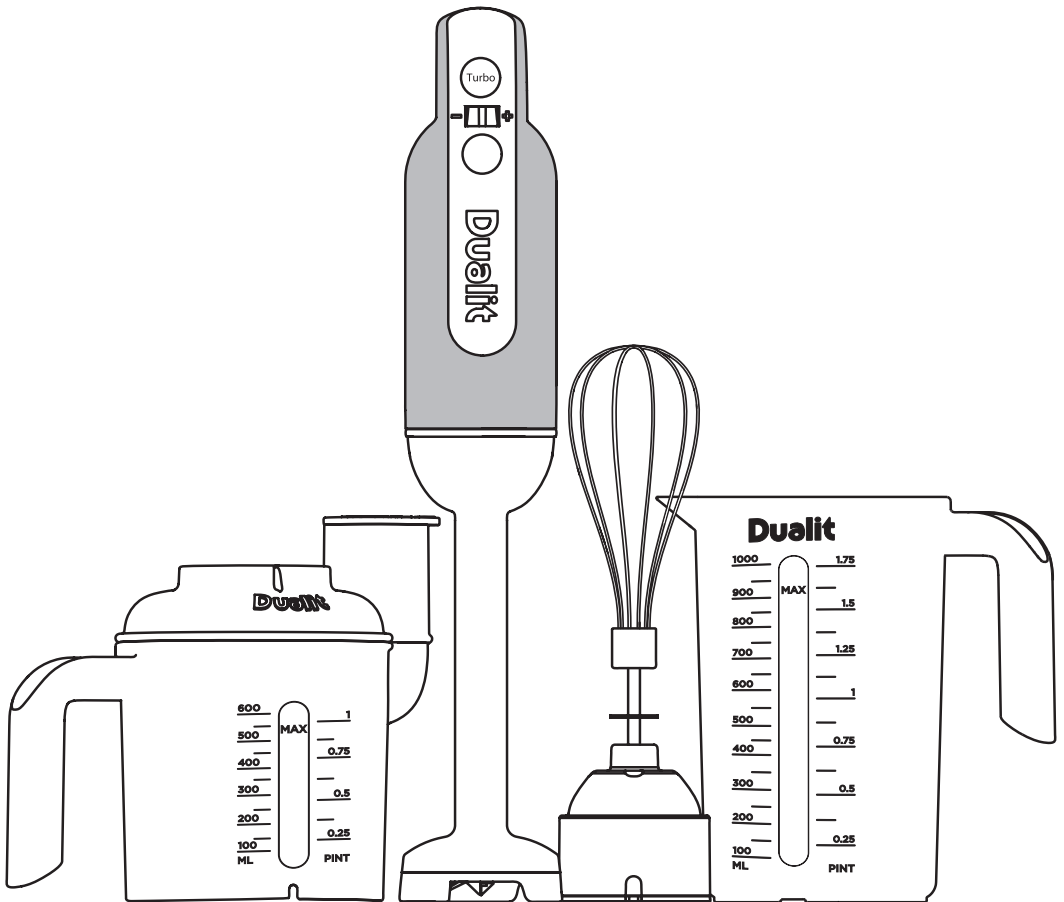

BLITZ, WHISK, CHOP AND PUREE!

With your multi-tasking kitchen assistant, you can now tackle cookery challenges with ease. Experiment with saucy salsa, smooth soups and summery smoothies, safe in the knowledge that they will be ready in a matter of moments. From quick weekday dinners for two, to baby food and gourmet dinner parties. Dualit's trusty Hand Blender is up to every kitchen challenge.

The Hand Blender is just one part of the Dualit Food Preparation family. A comprehensive collection of hard-wearing, thoughtfully designed kitchen gadgets that make light work of every culinary task.

Unpack the box with care, keeping all the packaging materials until you are satisfied everything is present and in working order. Once satisfied remove any tags from the hand blender and recycle the packaging appropriately. You may wish to keep the box to store your hand blender.

All illustrations are for representation only; your model may vary from illustrations shown.

CONTENTS

Safety precautions _____	04
Know your Hand Blender _____	06
Using your Hand Blender _____	08
Attaching and removing accessories _____	08
Using the Wand _____	09
Using Chopper Bowl and Gearbox _____	10
Using Balloon Whisk with Gearbox _____	12
Maximum Loading Chart _____	14
Useful Tips _____	16
Cleaning & Maintenance _____	18
Storing your Hand Blender _____	20
Troubleshooting _____	21
Cooking Tips _____	22
Recipes _____	24
Guarantee _____	35



IMPORTANT SAFETY PRECAUTIONS



READ ALL THE INSTRUCTIONS

CAREFULLY BEFORE USING YOUR DUALIT HAND BLENDER. KEEP THESE INSTRUCTIONS SAFE FOR FUTURE REFERENCE

Always follow these safety precautions when using your hand blender for your own safety and to avoid damaging the appliance.

- To protect against risk of electrical shock, do not submerge the main body, cord or plug, in water or any other liquids. Do not allow liquid into the join where the main body and attachments meet.
- This appliance shall not be used by children. Keep the appliance and its cord out of reach of children.
- Children shall not play with the appliance.
- Appliances can be used by persons with reduced physical, sensory or mental capabilities or lack of experience and knowledge if they have been given supervision or instruction concerning use of the appliance in a safe way and understand the hazards involved.
- Do not use outdoors, in moving vehicles, boats or caravans.
- This appliance is intended for domestic use only. If the appliance is used improperly, for professional, semi-professional purposes or if it is not used according to these instructions, the guarantee becomes invalid and Dualit refuses any liability for damage caused.
- Never tamper with the safety systems. They are included for your personal safety.
- To avoid serious injury, should the unit start accidentally, unplug from outlet when: not in use, moving the appliance, before attaching or removing parts, before cleaning or storage.

- Do not place hand blender near edge of work surface.
- Do not let cord hang over edge of table or counter.
- Keep hands and utensils out of containers while blending to reduce the risk of severe injury to persons or damage to the blender. A scraper should be used but must be used only when the hand blender is not running and blades safely removed.
- Blades are sharp. Handle carefully. Avoid contact with moving parts as serious injury could result
- Be careful if hot liquid is poured into the food processor or blender as it can be ejected out of the appliance due to a sudden steaming.
- Always operate chopper bowl with lid securely in place. The bowl may leak if the lid is damaged, incorrectly fitted or over-filled.
- Do not disconnect accessories from the main body before the motor has stopped.
- Keep fingers, clothing, utensils and hair away from moving parts.
- Never reach into the chopper bowl with your fingers or an object (e.g. a spatula) while the hand blender is running.
- **This is an attended appliance. Do not leave appliance unattended during use. Unplug appliance when unattended.**
- The use of attachments not recommended or sold by the manufacturer may cause fire, electric shock or injury.
- If the chopper blade, wand blades or whisk is jammed, switch off and unplug the hand blender before removing the blockage.
- The noise level of this appliance is $L_c > 70\text{dB}$.
- For safest use it is recommended to remove pan from the stove and allow liquids to cool to room temperature before blending. **Never blend**

hot oil or fat.

- Do not add boiling liquids or foods to the chopper bowl. Always cool liquids or food items.
- Do not insert frozen items into jug or chopper bowl taken directly from a hot dishwasher.
- Do not immerse or wash jug or chopper bowl in boiling or very hot water.
- When blending heavy loads pulse for 30 seconds and allow cooling until room temperature between each pulse. Please note that no recipe contained within the manual is considered a heavy load.
- Do not operate the chopper bowl while empty.
- Never carry or pull the appliance by the cord.
- Make sure the electrical outlet is rated at the same A.C. voltage as that stated on the bottom of the main body. Do not use if the voltages are different.
- If the power cord is damaged it must, for safety reasons, be replaced by Dualit or an authorised Dualit repairer.
- Do not operate the hand blender with a damaged cord or plug.
- Do not operate the hand blender after appliance malfunctions.
- Do not operate the hand blender if it is dropped and shows signs of damage. Return appliance to the nearest Authorized Service Centre for examination, repair or electrical or mechanical adjustment when there is any indication of damage.
- This product is fitted with a resettable thermal cut-out and surge protection, if the motor stops, the unit is not broken, stop, unplug, allow to cool and then restart.
- **CAUTION:** In order to avoid hazard

following inadvertent resetting of the thermal cut out, this appliance must not be supplied through an external switching device such as a timer or connected to a circuit which is regularly turned off by the utility.

- We recommend that the appliance is plugged into a socket that has no other appliance connected to it. Failure to do this may cause an overload, trip a circuit breaker or blow a fuse. Preferably the socket outlet should be protected by a Residual Current device (RCD).
- The maximum rating is based on the attachment that draws the greatest load. Other attachments may draw less power.
- Be careful if hot liquid is utilised with the Hand Blender or its accessories as it can be ejected out of the container due to a sudden steaming.
- Do not throw away the appliance with the normal household waste at the end of its life, but hand it in at an official collection point for recycling. By doing this, you help to preserve the environment.



SAVE THESE INSTRUCTIONS

BEFORE FIRST USE

- Read this instruction book thoroughly.
- Clean all parts in contact with food before using for the first time. Wash with lukewarm water and detergent, then rinse and dry.
- Treat the blades with respect – they are very sharp!
- When you turn the hand blender on for the first time, a “new” smell may be given off, this will dissipate after a few uses.

KNOW YOUR HAND BLENDER

TURBO
SPEED CONTROL
POWER BUTTON

MAIN BODY
(NOT DISHWASHER SAFE)

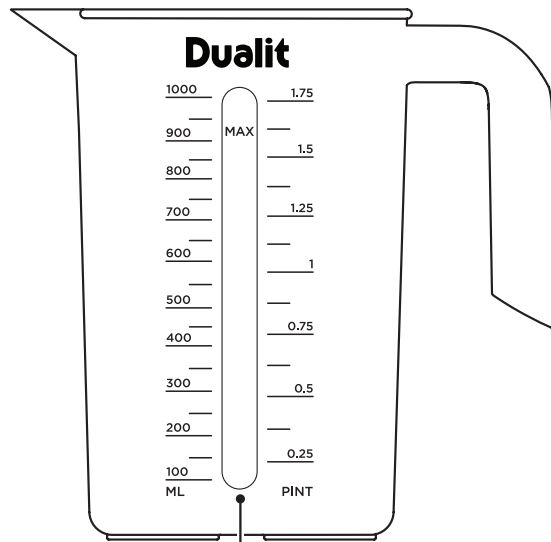
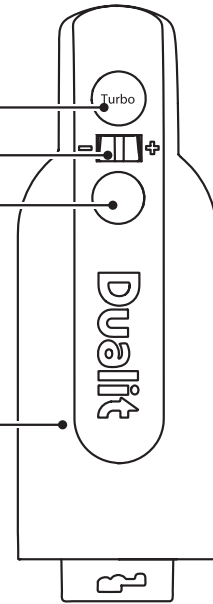

JUG
(DISHWASHER SAFE)

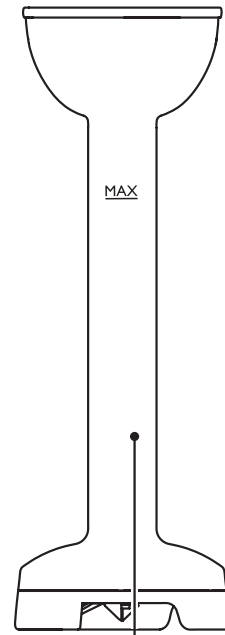

WAND
(DISHWASHER SAFE)

BALLOON WHISK
(DISHWASHER SAFE)

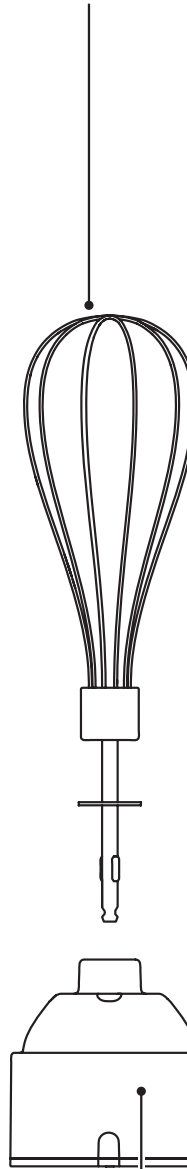

GEARBOX
(NOT DISHWASHER SAFE)

FEED TUBE
COVER

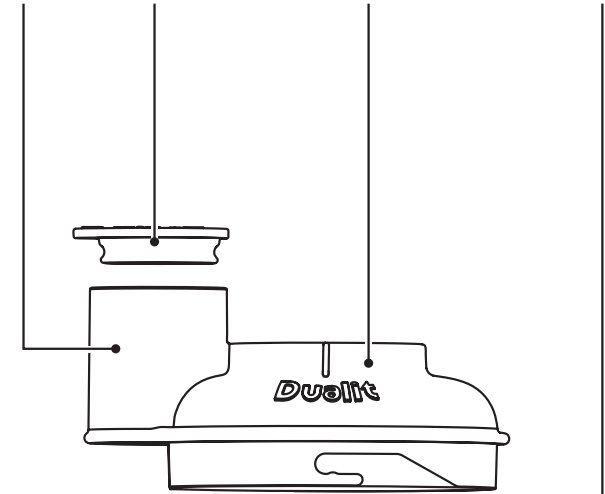

CHOPPER LID
(DISHWASHER SAFE)

CHOPPER BLADE
(DISHWASHER SAFE)

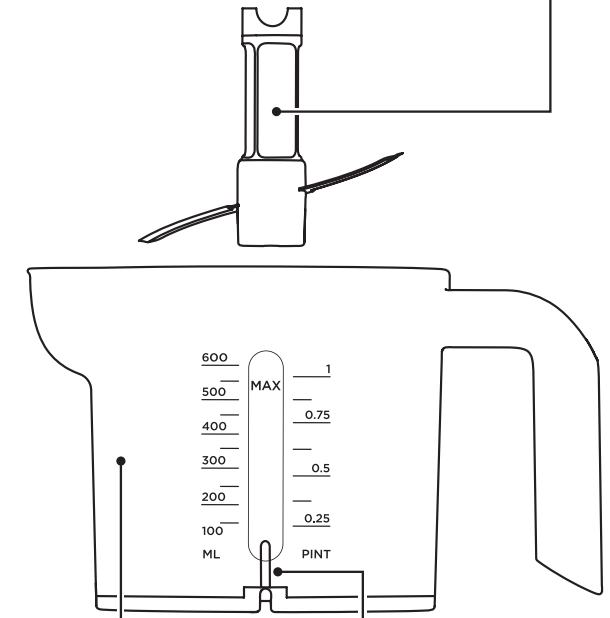

CHOPPER BOWL
(DISHWASHER SAFE)

CHOPPER
BOWL SHAFT

USING YOUR HAND BLENDER

The following sections will explain use of your hand blender. Please read this section carefully.

Do not blend for more than 1 minute in any 4 minute period, if you accidentally do, unplug and leave the hand blender to fully cool to room temperature before re-using.

For max loadings see chart on page 14.

ATTACHING AND REMOVING ACCESSORIES

Do not attach or remove accessories with the main body plugged in to the supply.

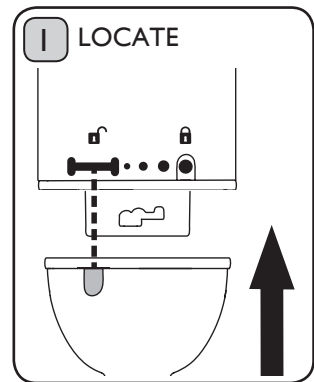

To attach the Wand or Gearbox - Hold the Main Body firmly with one hand, align the indent with the unlock symbol.

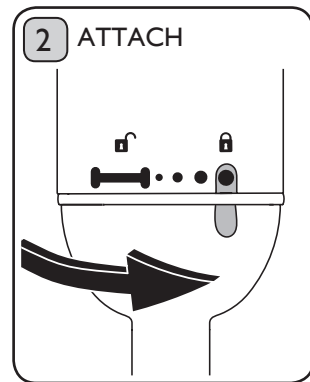

Push and twist the accessory clockwise with your other hand, until the indents on the sides of the parts are aligned.

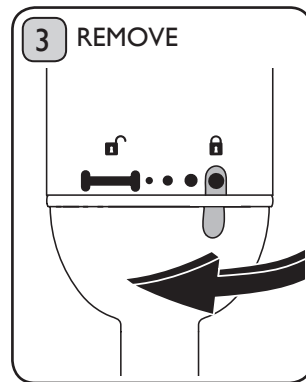

To remove the accessory, unplug and reverse the procedure.

USING THE WAND

The wand is a powerful tool for liquidising or mixing ingredients. For max loadings see chart on page 14.

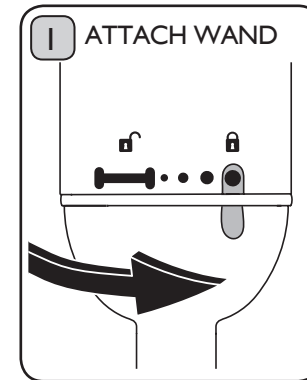

Ensure the hand blender is unplugged. Attach the wand to the main body. Ensure the wand is securely attached into the main body.

Caution: avoid contact with the blades.

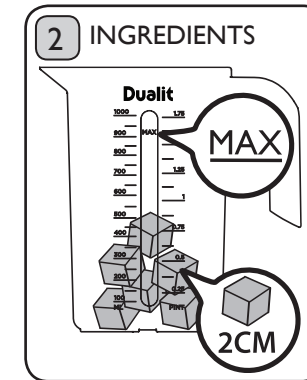

Place your ingredients into a tall container, pan or mixing jug to avoid splashing.

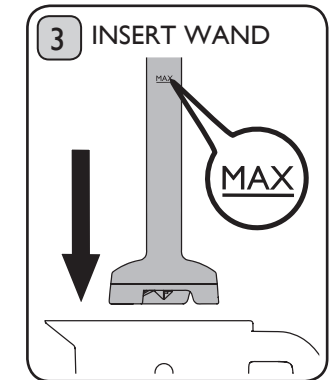

Dip the wand deep into the pan or jug ensuring the depth of the mixture does not exceed the 'Max' marks on the wand shaft. NOTE: Keep wand foot submerged to avoid splashing.

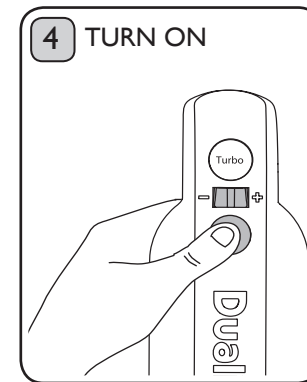

Plug in the hand blender. **Set the speed to minimum (-)**, press the power button to start blending.

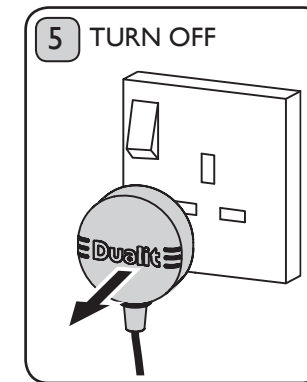

When blending is complete, release the power button then unplug.

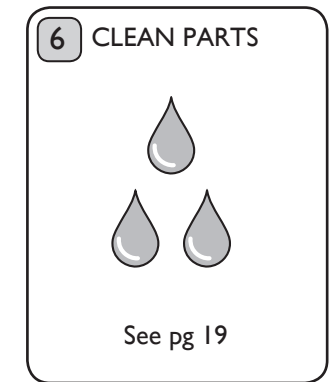

Remove the wand from the main body. Remove the wand from the jug or pan before pouring. Clean parts immediately after use (see pg 19 for cleaning instructions).

USING THE CHOPPER BOWL & GEARBOX

With its sharp blades and 600ml capacity, the chopper bowl accessory is compact and handy for dry ingredients. For max loadings see chart on page 14.



For best results short and regular 1 second pulses are recommended.

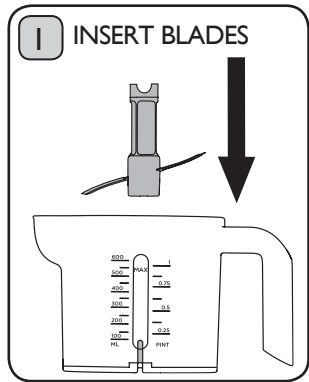

Ensure the hand blender is unplugged. Insert the blade in the chopper bowl; locate it over the chopper bowl shaft. **Caution: blades are sharp!**

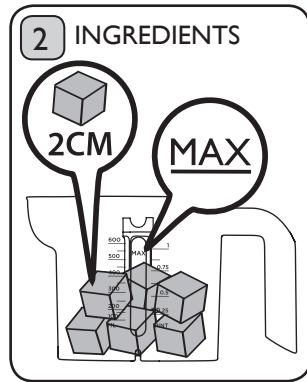

Distribute ingredients evenly in the bowl. Pre-cut larger pieces of food into even-sized cubes (approximately 2cm). Do not fill above the MAX. **Note: Never put food in before blade.**

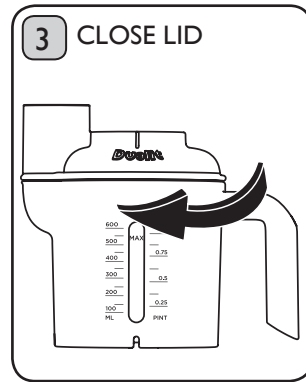

Place the lid on the bowl and rotate clockwise to lock. **Ensure lid is correctly locked in place with the feed tube and spout aligned.**

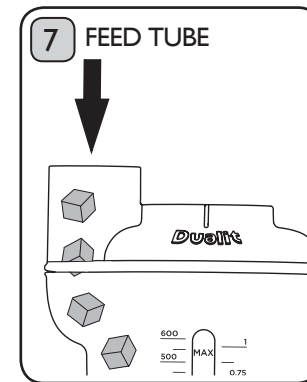

Ensure the hand blender is unplugged. Remove the feed tube cover and drop ingredients down the feed tube into the bowl. **Never reach into the feed tube with your fingers or utensils (e.g. a spatula).**

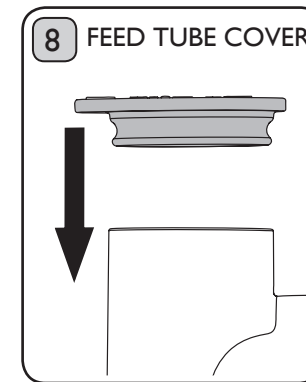

Replace the feed tube cover. **Plug in the appliance** and continue operating the hand blender.

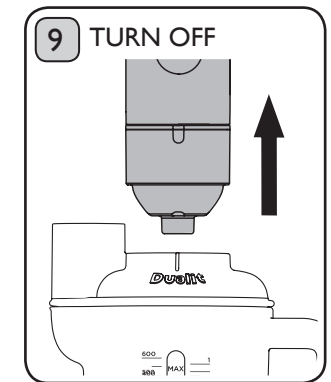

When chopping is complete, release the power button then unplug. Ensure the motor and blades have stopped then lift the main body and gearbox vertically off the chopper bowl lid.

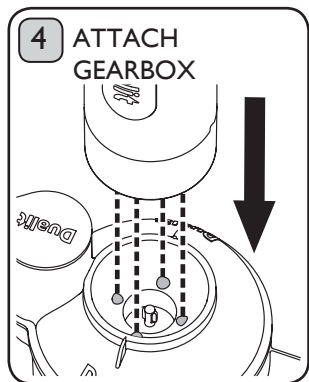

Attach the gearbox to the centre of the lid. Align the four protruding dimples.

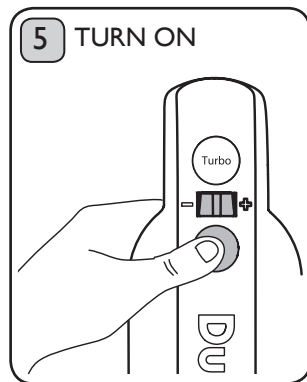

Plug in the hand blender. **Set the speed to minimum (-)**, press the power button to start chopping.

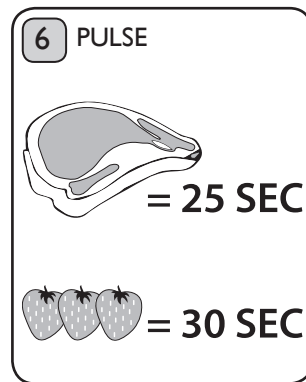

Pulse for a maximum of 25 seconds for meats or tough ingredients, 30 seconds for liquids and soft ingredients. Note: Use repeated short pulses (no more than 1 second) for best results.

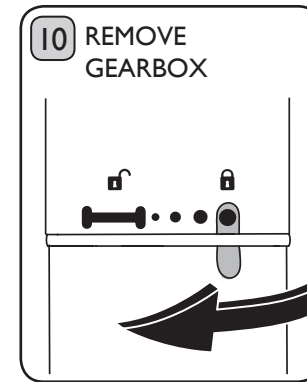

Remove the gearbox from the main body by twisting anti-clockwise.

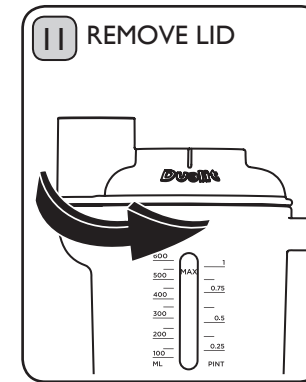

Rotate the lid anti-clockwise. If scraping out a mixture take out the blades first. **Never touch the cutting edges of the blades.**

Caution: blades are sharp!

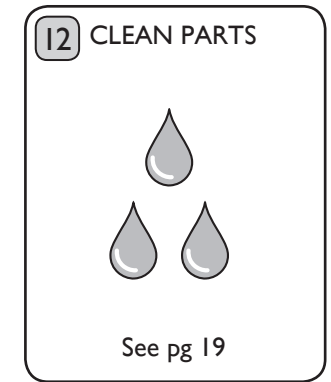

Clean parts immediately after use (see pg 19 for cleaning instructions).

USING THE BALLOON WHISK WITH GEARBOX

The balloon whisk is the perfect tool for incorporating air into light ingredients to create featherweight results. For max loadings see chart on page 14. Note: to prevent splashing use Mixing Jug supplied.

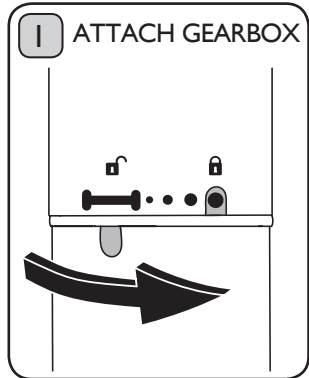

Ensure the hand blender is unplugged. Attach the gearbox to the main body. Ensure the gearbox is securely attached into the main body.

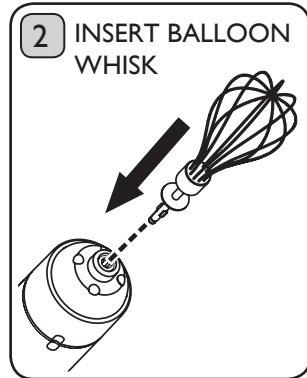

Hold the main body with one hand and the whisk stem with the other hand and insert the whisk with a slight twist and push action until they click in to place.

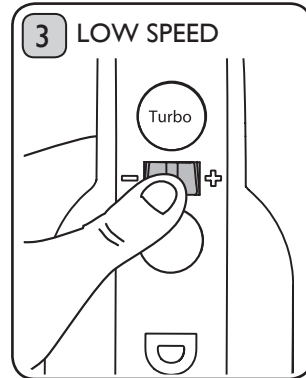

Plug in the hand blender. Dip the whisk well into the mixture. **Set the speed to minimum (-).**

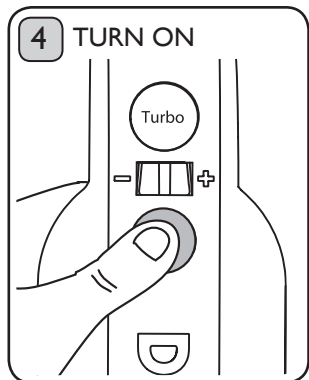

Press the power button to start whisking.

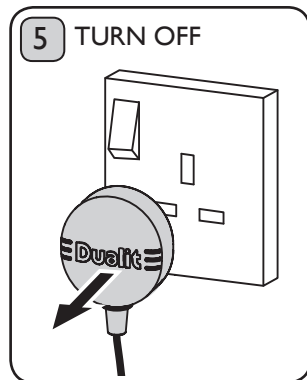

When whisking is complete, release the power button then unplug from the mains.

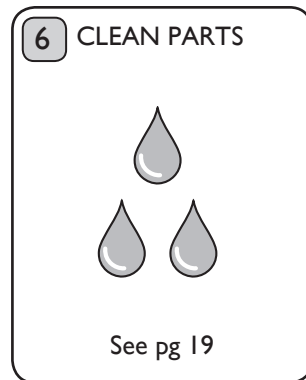

Detach whisk by firmly holding main body or gearbox & pulling the whisk downwards. Remove gearbox from the main body. Clean parts immediately after use (see pg 19 for cleaning instructions).

MIXING TIPS

For best chopping results add ingredients gradually via the feed tube. This appliance is not suitable for frozen mangos, un-melted chocolate, coffee beans, seeds, uncooked-rice etc. Generally, there is not one set speed for an entire recipe. You will need to change the speed of the mixer depending on what stage of the recipe you are working on. This is communicated in the recipe section.

1. When processing liquids, such as soups with the wand, always ensure the foot is submerged in the liquid to prevent splashing. Do not process uncooked vegetables.
2. When chopping small quantities of ingredients use a low speed and a pulsing action.
3. Do not process ice in the chopping bowl.
4. For best results pulse repeatedly, holding the button for no longer than 1 second.

Extra or replacement accessories can be purchased directly from Dualit. A second chopper bowl or mixing jug can be useful extras in busy kitchens. A Dualit apron can also make a perfect gift. Knife Blade – contact customer services for availability details. Note: Its max capacity is 70g of 2.5cm³ cubed beef on turbo speed for 3 seconds (not supplied in pack).

MAXIMUM LOADING CHART

Use the chart below as a guide to determine the maximum amount of ingredients to be mixed at one time.

ATTACHMENT	RECIPE / INGREDIENT	MAXIMUM QUANTITY	RECOMMENDED SPEED	APPROX. PROCESSING TIME /SECONDS
WAND* WITH MIXING JUG	Smoothies, Milkshakes	Do not exceed max mark on the wand	Turbo+	20
	Fruit yoghurt	500g Yoghurt + 150g of Fruit	High	20
	Cooked Carrot	800g	Medium	30
	Soup or baby food	Do not exceed max mark on the wand	Medium-High	30
CHOPPER BOWL* AND KNIFE BLADE	Mayonnaise	2 egg yolks+ 300ml sunflower oil added gradually via feed tube	Medium	30
	Dressing	300ml olive oil + 100ml vinegar add Dijon mustard as desired	Medium	30
	Tomato, Onion	400g	Medium	30
	Breadcrumbs	3 large slices of bread (150g, add gradually via feed tube)	Turbo+	30
	Lean Meat (Pork, Chicken, Beef or Fish; cut into 2cm cubes)	450g	Medium	20
	Nuts	200g	Turbo+	20
	Herbs	30g	High	30
WHISK** WITH SUITABLE MIXING BOWL (NOT SUPPLIED)	Cream	500ml	Low	60
	Egg Whites	4	Low	60
	Cake Mix	3 egg cake mix (150g flour, 150g sugar, using softened butter)	Low	60

OPERATION AND REST TIMES:

* Do not blend or process for more than 1 minute in any 4 minute period, if you accidentally do, unplug and leave the hand blender to fully cool to room temperature before re-using.

**Rest appliance for 1 minute per every minute of whisking.

USEFUL TIPS

- Roughly chop ingredients before blending for best results.
- Hold the chopper bowl or mixing jug steady during use, use a high sided bowl for whizzing even small amounts to prevent splattering.
- The variable speed control can vary the speed of the motor from 7000-16000rpm. For best results start blending on the lowest setting and gradually increase the blending speed.
- For best results work through the ingredients with a gentle up and down movement of the main body.
- To store a mixture in the jug, cover and refrigerate as required.

MIXING

The mixing jug is ideal for whipping up a quick smoothie or making frothy coffee. Blending is fast, easy and clean. Use the wand for mixtures that include solids such as fruits, ice cream etc.

- Make homemade smoothie in minutes. Even fruit which is just past its best can be used. Most soft fruits are suitable. Stir into cereal for a nutritious breakfast. To serve as a drink, pour the mixture into a glass and add milk, yogurt and/or fruit juice.
- No need to go out for a frothy coffee. Bring some semi-skimmed milk to the boil in a pan and whizz to a froth using the turbo button. Pour into a cup of hot coffee and stir in gently, also good with instant coffee.
- For homemade hot chocolate, heat a cupful of milk until just boiling. Remove from heat and drop in a couple of blocks of chocolate. Wait for it to soften and then whizz with the Dualit hand blender using the power button, then change to the turbo setting to froth.

WHISKING

- Ingredients are whisked to incorporate air. By tipping a bowl at a safe angle, even more air can get into the mixture, resulting in light mixtures and increased volume.
- Whisked egg whites provide the base for soufflés, mousses and all types of meringues.
- The mixing bowl must be spotless as a speck of grease will stop egg white from holding air. Rub the bowl with a cut lemon if you have any doubts.
- Start slowly and only use a faster speed when the mixture starts to turn white.

CHOPPING

- Chop onions and garlic by putting into the chopper and whizzing, no smelly fingers!
 - Grate cheeses in moments, ready for adding to sauces or sprinkling over baked dishes. Chop into 1.5cm cubes, place in chopper bowl and whizz.
 - Produce fresh breadcrumbs with ease. Slightly stale white bread makes the fluffiest crumbs. Remove the crusts and cut into cubes. Half fill the chopper bowl and whizz until fine. Make in batches and store in the freezer.
 - Nourishing, healthy soups can be quickly made in the chopper using cooked leftovers. Root vegetables, tomatoes, pumpkin, squashes and courgettes are all suitable. Use flavourings such as curry powder, ginger, cumin, or sprigs of thyme, and a dash of soy sauce to add piquancy.
 - To obtain the greatest volume when beating egg whites, be sure the bowl and beater are completely clean and dry before use. The smallest amount of grease or water can prevent the whites from aerating.
-
- The term "soft peaks" means that the egg white barely supports itself. When the head of the mixer is lifted, the egg white mixture will curl and may fall from the beater.

CLEANING AND MAINTENANCE

IT IS IMPORTANT TO CLEAN THE HAND BLENDER AND ALL PARTS IN CONTACT WITH FOOD AFTER EACH USE.

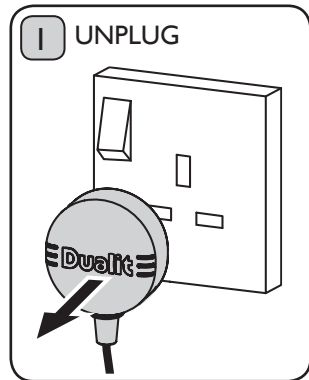

ALWAYS SWITCH OFF AND UNPLUG BEFORE ANY CLEANING. NEVER USE ABRASIVE CLEANERS ON ANY OF THE PARTS.

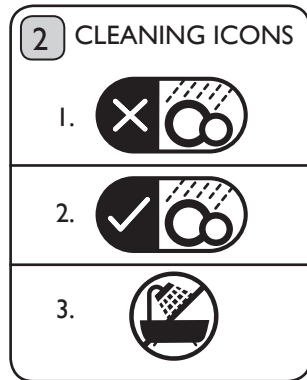

Look for these symbols on the parts and follow the instruction:

1. Not dishwasher safe
2. Dishwasher safe
3. Do not immerse parts

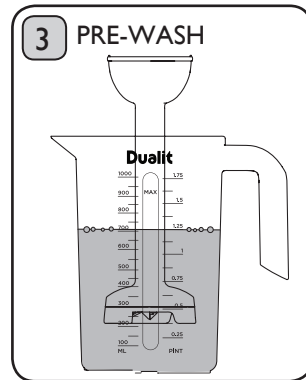

To remove food particles from wand, chopping bowl and balloon whisk fill a jug (or half fill chopping bowl) with warm soapy water and whizz using the turbo button.

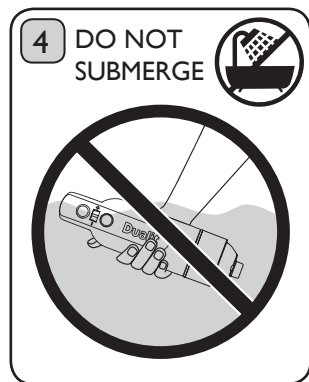



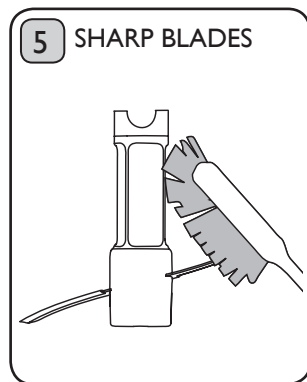





Do not submerge, or partially submerge the main body or gearbox in any liquid.



Caution: avoid contact with the blades. Use a cleaning brush and soap suds when washing the blades.



Do not use harsh or abrasive cleaning agents, solvents or steel wool. Use a damp cloth.

COMPONENT	CLEANING	DRYING
MAIN BODY  	Wipe exterior surface with a damp cloth. NOT DISHWASHER SAFE.	Dry thoroughly with a cloth.
GEARBOX  	Wipe exterior surface with a damp cloth. NOT DISHWASHER SAFE.	Dry thoroughly with a cloth.
WAND 	Place on the top rack of the dishwasher, on a sub 40 degree wash cycle. Keep well away from the heating elements Or wash the wand under running water.	Drain the wand by resting it upside down (blades pointing up) and dry carefully with a cloth. This allows water to drain from inside the wand.
WHISK 	Place on the top rack of the dishwasher, on a sub 40 degree wash cycle. Keep well away from the heating elements. Or wash the wand under running water.	Dry thoroughly with a cloth.
CHOPPER BLADE 	Place on the top rack of the dishwasher, on a sub 40 degree wash cycle. Keep well away from the heating elements. Or wash the wand under running water.	Dry thoroughly with a cloth.
CHOPPER BOWL, LID & FEED TUBE COVER 	Place on the top rack of the dishwasher, on a sub 40 degree wash cycle. Keep well away from the heating elements. Or wash the wand under running water.	Dry thoroughly with a cloth.
JUG 	Place on the top rack of the dishwasher, on a sub 40 degree wash cycle. Keep well away from the heating elements. Or wash the wand under running water.	Dry thoroughly with a cloth.

STORING YOUR HAND BLENDER

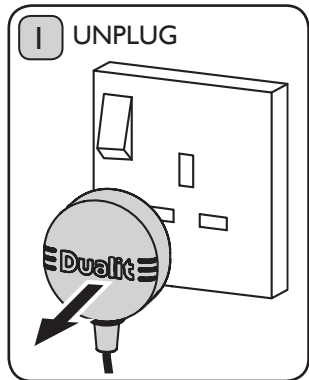

ENSURE THE HAND BLENDER IS UNPLUGGED WHILST IN STORAGE



Ensure the unit is thoroughly cleaned before storing. Bacteria can build up quickly if not cleaned and food is left on the unit.

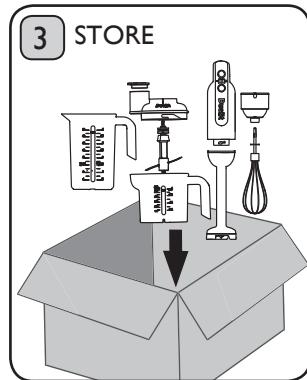

Place the hand blender in its box in a cool, dry place and away from the reach of children.

TROUBLESHOOTING

POSSIBLE CAUSE(S)	SOLUTION(S)
THE HAND BLENDER DOES NOT TURN ON	
1. The unit may not be properly connected to the power supply.	1. Check the plug is in the socket and the switch is turned on.
2. The unit's thermal fuse may have activated, temporarily disabling it.	2. This product is fitted with a resettable thermal cut-out and surge protection, if the hand blender does not turn on or the motor stops, the unit is not broken, stop, unplug, allow to cool and then restart.
THE BLENDER BODY GETS HOT	
1. The unit may have been used for an extended period of time.	1. Allow the unit to fully cool. Your hand blender is designed for intermittent use, the motor is very powerful, see operation and rest times below max loadings in this instruction book.
2. The unit may have been processing a heavy load.	2. Some heat will be generated during normal use, particularly on very hot days, never leave to rest in direct sunlight.
3. The unit may have been left near a heat source.	3. Store in a cool, dark place.
THE MIXTURE IS NOT BLENDING	
1. You may have exceeded maximum volumes.	1. Refer to max loadings chart (pg 14) and blend ingredients in smaller batches.
2. Ingredient chunks may be too large.	2. The food chunks are too large, try chopping into smaller chunks and try again.
3. The speed of chopping may not be appropriate for the ingredients.	3.1 You are using the wrong speed selection, set to a slower speed, pulse and gradually increase mixer speed.
	3.2. The blade may be damaged, contact Dualit for further advice and spares information.
I GET SPLASHES WHEN I BLEND	
1. The unit has very powerful blades and attachments which rotate very fast.	1.1 Dip the wand into the mixture before turning the power on.
	1.2 Try using a deeper bowl or jug, even when blending small mixtures.
	1.3 Set the speed wheel to a slower setting and then increase speed as you blend.
	1.4 Do not go over the MAX mark on the sides of the wand while blending.

INGREDIENTS

The importance of good quality and fresh ingredients will make a huge difference to any recipe. Remember, the fresher the better and quality over quantity.

- For the best results, try to use good quality oils and condiments. Sour, bitter or

rancid oil can spoil a recipe, whereas a drizzle of good quality, cold-pressed olive oil can lift a dish.

- Sea salts, such as Maldon or other sea salt crystals, are more expensive than table salt, but are unsullied by

processing and additives, and well worth the extra expense. They taste better and are a pleasure to handle.

- Pepper is always best freshly milled and Parmesan cheese should be freshly grated.

DAILY USES FOR YOUR HAND BLENDER

Get in the habit of using your hand blender and bring a bit of fun into the preparation of quick meals, snacks and drinks.

- **Fruit smoothies** are fashionable, healthy and a great pick-me-up for the "morning after". Break a banana into the tall jug and add a handful of one or two fruits, e.g. strawberries, blueberries, pear or apple, with a teaspoon of honey and/or wheatgerm. Blitz with the blender to a rough pulp. With the blender running, gradually pour in some milk to the consistency you like and the smoothie is ready to drink.
- No need to go out for a **frothy coffee**. Bring some

semi-skimmed milk to the boil in a pan and whizz to a froth using the turbo button. Pour into a cup of hot coffee and stir in gently without breaking the bubbles - also good with instant coffee.

- For **hot chocolate**, break up 40g (1½ oz) good dark chocolate, at least 60% cocoa solids. Heat 250ml (9fl oz) a cupful of milk, until just boiling. Remove from heat and drop in the chocolate. Wait a minute for it to soften and then whizz on a slow speed. Then change to the turbo setting to froth. Serve immediately.
- The Dualit hand blender is so useful for blending

soups – thick cream soups of winter vegetables for a nourishing lunch for one or two, cold summer soups, or posh soups for smart dinners. There are four soup recipes in this booklet, but simply cooking some chopped onion in a little butter or oil and adding almost any vegetables (including leftovers and salad greens), or a tin of beans (rinsed), some stock, herbs or curry powder, a spoon of crème fraîche and/or a dash of wine can make a delicious soup. Don't be afraid to experiment. Whizz it together with the hand blender and serve.

- Make **dips and mayonnaise**

DAILY USES FOR YOUR HAND BLENDER

mixes from store cupboard ingredients, and serve with chopped raw vegetables for a healthy light snack or starter.

- Treat your family and friends to **homemade pesto** – so different from bought sauce, but simple to make. Tear a large bunch of fresh basil (about 50-75g) into a bowl including the stalks. Drizzle over 3 tablespoons olive oil and add a large crushed garlic clove. Blitz together using the speed button until the leaves break down then pulse to a pulp using turbo. Add 4 heaped tbsp (about 50g) grated parmesan cheese or pinenuts (or both) and continue pulsing to a smooth paste. Add a little salt and pepper and 2-3 tbsp warm water. Transfer to a jar and keep in the fridge for up to a week.

- Why buy **salad dressings and marinades** when you can whizz up fresh ones? The Dualit hand blender is perfect for making smooth, shiny vinaigrettes and dressings. Balsamic, mustard and soy dressing is lovely on a salad and doubles as a marinade for lamb or chicken. Put 2

teaspoons Dijon mustard into a medium sized bowl. Add 2 tbsp soy sauce, 2 tbsp balsamic vinegar and some sea salt and pepper. Whizz. then with the blades still running pour in a teacup of olive oil, about 200ml (7fl oz), and 1 tbsp fresh lemon juice. Add about 6 fresh mint leaves at the end, if you have some, and pulse until coarsely chopped.

- **Frozen peas or broad beans** can be crushed to produce a tasty alternative to boiled vegetables Cook the peas or beans according to pack instructions. Drain off most of the water. Add a good knob of butter and 2-3 leaves fresh mint (for peas), if liked. Blitz with the Dualit hand blender on the slowest speed until crushed but not smooth. Add salt and pepper and serve. Good with salmon, chicken, lamb or a pork chop.
- **Beat eggs** quickly and smoothly with your blender's whisk – especially when you have three or more to prepare.
- **To the rescue – lumpy sauces** can be smoothed

in seconds by whizzing with the Dualit hand blender on the turbo setting. A curdled hollandaise sauce can be improved with 2 tbsp of cold water and a quick blitz make pancakes a regular feature on your menu, especially if you have children to cook for. Use a packet mix, or quickly make your own. Put 100g plain flour into a large bowl with a pinch of salt, and 1 tbsp caster sugar if you want sweet pancakes. Break in an egg and using the hand blender, whizz lightly. Then with the blender on its slowest setting, incorporate a cup of milk, 250ml (9fl oz), until you have a smooth batter. This can be used immediately without standing. For a special breakfast pancake, use the Buttermilk pancake recipe (See Buttermilk breakfast pancakes in the next section).

- **Dry ingredients:** use flat bottomed bowl with steep sloping sides, the hand blender will mix dry ingredients perfectly.

BREAKFAST

BUTTERMILK PANCAKES MAKES 16

- 75g porridge oats
- 2 x 287ml cartons buttermilk
- 100g plain flour
- 60g wholemeal flour
- 2 tbsp caster sugar
- 1 tsp ground cinnamon
- 1 tsp bicarbonate of soda
- 1 tsp baking powder
- ¼ tsp sea salt
- 2 eggs
- 2 tbsp vegetable oil, plus extra

Whizz up this healthy batter and cook in spoonfuls as blini-size pancakes. They are delicious served with maple syrup or runny honey. For special breakfasts add fresh soft fruits and dollops of yogurt or lightly whipped cream (see page 33). Then add the remaining ingredients and whizz with the Dualit hand blender until just mixed. Do not overbeat.

- For cooking, soak the oats in the buttermilk in a medium sized bowl for 15 minutes.
- Then add the remaining ingredients and whizz with the Dualit hand blender until just mixed. Do not overbeat.
- Heat a non-stick frying pan until hot, swirl in a little oil and drop in small ladles of batter, about 2 tablespoons each.
- Three or four pancakes may be cooked together, depending on the size of the pan. Add extra oil as needed.
- Cook on a medium heat until bubbles appear on top (about 2-3 minutes), then flip over and cook for a further 30 seconds.
- Stack under a tea towel to keep warm until all the batter is used.

BERRY-BANANA BREAKFAST BOOSTER SERVES 2

- 200g Greek yoghurt
- 1 x medium banana
- 250ml milk
- 4 teaspoons of honey
- 200g blueberries or mixed berries of your choice
- 60g oats.

Dualit's Breakfast Booster Smoothie counts as two of your five a day, and the blast of banana gives you a dose of potassium, helping you power through busy mornings until lunch.

Strawberries should be hulled and frozen berries should be defrosted before use.

- Place all the ingredients in Dualit's Hand Blender jug.
- Use Dualit's Hand Blender wand to mix until combined, taking care not to immerse further than the 'MAX' marking on the wand.
- Pour into a glass and enjoy.

DIPS AND PÂTÉS

QUICK GUACAMOLE SERVES 2 OR 3

- 1 large ripe avocado
- 2 fat cloves garlic, peeled and roughly chopped
- 1 spring onion, roughly
- chopped
- 1 tomato, roughly chopped
- 1 tsp ground cumin
- Juice 1 lime
- Salt and freshly ground black pepper

Fresh homemade guacamole takes next to no time to prepare using the Dualit hand blender and makes an excellent little dish to serve with drinks. For a bright green colour, make this no more than 10 minutes ahead of serving. (See recipe for Avocado sauce (page 29) for a tip on keeping the colour.)

- Cut the avocado into two, discard the stone and scoop out the flesh with a spoon into a small mixing bowl.
- Add the garlic and onion and pulse a little with the hand blender to mix.
- Add the tomato, cumin and some salt and pepper and continue pulsing until the tomato is roughly crushed. Then add the lime juice and pulse for a few more seconds.
- The texture should be crushed and creamy but not completely smooth.
- Spoon into a pretty bowl and serve with tortilla chips, bread sticks, crisp breads or toast fingers.

SALMON PÂTÉ SERVES 2

- 125g smoked salmon
- 1 spring onion
- 100g cream cheese or low fat soft cheese, softened in a warm place
- 2 tsp chopped fresh dill (or parsley if unavailable)
- 1 tsp horseradish or Worcestershire sauce, or few dashes of hot pepper sauce
- A little fresh lime or lemon juice
- Salt and freshly ground black pepper

Small pack of smoked salmon and a few everyday ingredients can be turned into a creamy pâté for a speedy starter or party dip.

- Roughly snip the salmon and spring onion into pieces with scissors, into a medium sized bowl. Pulse with the Dualit hand blender until roughly chopped.
- Add the cream or soft cheese, dill or parsley, horseradish or sauce, and salt and pepper. Continue pulsing until well mixed but still retaining some texture. Add lime or lemon juice to taste and check for salt and pepper.
- Spoon into a couple of ramekins and chill until firm. Serve with fingers of toasts or plain crackers.
- Alternatively, make a bed of rocket salad on each plate and spoon the pâté into mounds on top.

DIPS AND PÂTÉS

CREAMY BLACK OLIVE, ANCHOVY AND TUNA PASTE SERVES 4

- 60g marinated pitted black olives, packed in olive oil
- 30g tinned anchovies in Olive oil, drained
- 30g tinned tuna fish in Olive oil, drained
- A pinch dried thyme
- A few fresh almonds, skinned and crushed
- Extra virgin olive oil to taste toast or croûtes to serve
- For garnish: a few capers, rinsed

This recipe is Spanish and makes a fabulous tapas snack, canapé or spread. The better the quality of the ingredients, the more delicious it becomes.

- Place the first six ingredients in a large bowl, and blitz with the hand blender, scraping the sides of the bowl down well. Add a little extra virgin olive oil if necessary. Whizz to a thick cream.
- For canapés, cut the toast into small squares and spread the paste onto them. Garnish each with a caper and a sprig of parsley.
- Alternatively, press the mixture into a little china dish, put some capers and chopped parsley on top and serve with the toast.

SOUPS

CARROT, LEMON AND TARRAGON SERVES 4

- 500g carrots
- 1 onion, chopped
- 1-2 tbsps olive oil
- Small bunch of fresh tarragon
- 1.25 litres vegetable or chicken stock (can be made with bouillon powder or a stock cube)
- 2 strips of lemon zest and the juice of a lemon
- Salt & ground black pepper
- Half fat crème fraîche or natural yogurt to serve

By keeping this simple, the full natural flavour of the carrots comes to the fore, underlined by a hint of fresh herbs. This is a great low calorie soup which is quickly blended until smooth with the Dualit hand blender. Thyme, coriander or basil can be used instead of tarragon.

- Peel, top, tail and chop the carrots and place in a saucepan with the oil. Heat until sizzling, then cover and cook on a gentle heat for 5 minutes. Add two sprigs of tarragon, the stock and salt and pepper to taste.
- Bring to the boil, add the lemon zest and simmer for 15 minutes until the carrots have softened.
- Remove the zest and pour off half the stock into a heat-proof jug.
- Using the Dualit hand blender, whizz the carrots in the pan until smooth and creamy. Return the saved stock, and bring back to the boil. Add lemon juice to taste and check for salt and pepper
- To serve: sprinkle with some chopped tarragon and small dollops of crème fraîche/yogurt.

CREAM OF MUSHROOM SERVES 4

- 2 tbsp olive oil
- 25g butter
- 1 onion, roughly chopped
- 2 fat cloves garlic, crushed
- 250g chestnut mushrooms, roughly chopped
- 15g dried porcini mushrooms and ceps
- optional leaves from 2 sprigs fresh thyme or ½ tsp dried
- 2 tbsp Amontillado sherry or vermouth, optional
- 700ml vegetable or chicken stock, can be made with bouillon powder or a cube
- 300ml milk
- Squeeze of fresh lemon juice
- Salt and freshly ground black pepper
- A little chopped fresh parsley, optional, to serve

Homemade mushroom soup is a treat, and needs few ingredients to make it special. Choose full flavoured chestnut mushrooms, and for real luxury add some dried ceps or porcini mushrooms. Soak them in hot water for ten minutes or so to reconstitute before using

- Heat the oil and butter in a medium saucepan until hot then stir in the onions, garlic, mushrooms (including the porcini and ceps, if using) and thyme leaves.
- Cover and cook on a low heat for 5 minutes. Uncover and mix in the sherry or vermouth, if using. Cook for a minute then stir in half the stock and some seasoning.
- Bring to the boil then simmer for 15 minutes. Using the Dualit hand blender, blitz the ingredients in the saucepan until smooth.
- Rub the purée of mushrooms through a sieve using the back of a ladle.
- Return the liquid to the pan. Stir in the remaining stock and milk then reheat to a gentle simmer
- Cook for another 5 minutes. Add the lemon juice and check for salt and pepper.
- Give the soup a little froth by plunging the blender up and down in the pan on the turbo setting, and serve immediately with some chopped parsley sprinkled on top.

ONION, POTATO & PARSLEY SERVES 4

- A good handful of parsley
- A large onion
- A large potato
- 30g butter
- 430ml light stock, made from a cube or powder
- A bay leaf
- A pinch of mace (optional)
- 140ml milk (optional)
- Salt and ground white pepper

These simple and inexpensive ingredients make a great soup. Serve in colourful mugs or bowls.

- Chop the parsley in the Chopper or using a knife. Scrape out and set aside. There is no need to clean the chopper bowl. Cut the onion into chunks, and whizz in the chopper or using your knife.
- Cut the potato into cubes with a knife. Melt the butter in a heavy based saucepan, add the potato and onion, cover with the lid and cook to soften very gently for 7-10 minutes, stirring from time to time to prevent browning.
- Then add the stock, bay leaf and mace, bring to the boil and simmer for 20 minutes, with the lid slightly ajar. It is cooked when you can crush the vegetables easily with the back of a spoon.
- Remove bay leaf and allow to cool slightly and blender till smooth or to required consistency.

WINTER GARDEN

VEGETABLE SOUP SERVES 4

- 1 tsp extra virgin olive oil
- 1 medium onion (peeled and chopped using Dualit's Hand Blender chopper)
- 1 medium onion (peeled and chopped using Dualit's Hand Blender chopper)
- 80g parsnips (peeled and cubed)
- 80g carrots (peeled and cubed)
- 80g turnips (peeled and cubed)
- 80g squash (quartered and deseeded)
- 80g butternut squash (quartered and deseeded)
- 80g thinly sliced savoy cabbage
- 1.5 litres vegetable stock
- Sea salt and freshly milled pepper

To garnish:

- A dollop of crème fraiche
- A drizzle of truffle oil
- 2 sprigs rosemary and 2 sprigs thyme (chopped using Dualit's Hand Blender chopper – double this amount if making croutons and save half for later)

This luxurious soup is a real winter warmer, offering a simple yet gourmet meal. We have used the vegetables listed below, but you could substitute with leftover winter vegetables or fresh produce from your vegetable patch. Don't be afraid to experiment.

- In a large saucepan, heat the olive oil and cook the onion and garlic, stirring gently at regular intervals. After ten minutes, the mixture should be sweet, soft, fragrant and lightly coloured.
- Add the chopped vegetables, vegetable stock and season with salt and pepper. Bubble and simmer until all is tender – this takes about 20-30 minutes. Remove the squash quarters from the mixture, scoop out the contents and place back into the saucepan, discarding the skin.
- Blend on a low speed with Dualit's Hand Blender. The anti-suction wand gives you full control in the pan. Blend until smooth and remove the Hand Blender from the saucepan. The soup is cooked when the vegetables can be crushed against the side of the pan easily with the back of a spoon.
- Serve immediately in heated bowls. Top with a crème fraiche swirl, a drizzle of truffle oil, and a sprinkling of rosemary and thyme. Enjoy with homemade croutons.

For the croutons:

- 2 sprigs rosemary (chopped in Dualit's Hand Blender chopper)
- 2 sprigs thyme (chopped in Dualit's Hand Blender chopper)
- 4 tablespoons olive oil
- 6 slices of bread, roughly torn into strips
- Place a few leaves of rosemary and thyme in Dualit Hand Blender's chopper bowl and chop until fine. Add the oil and the torn bread using the feeding tube, and chop until cubed.
- Place the chopped bread on a lined pan under the grill on a medium heat for ten minutes until lightly browned. Serve with a delicious bowl of hot soup.

SAUCES

WATERCRESS SAUCE SERVES 2

- A bunch of fresh watercress, approximately 100g
- 1 large shallot or small onion, roughly chopped
- 25g butter or 2 tbsp olive oil
- 2 tbsp dry white wine, optional
- 140ml single cream, or 200ml half fat crème fraîche
- A squeeze of fresh lemon juice, if using single cream
- Salt and freshly ground black pepper

This British classic sauce is packed with a range of important vitamins and minerals. Its fresh and distinct flavour makes it a perfect partner for steamed or grilled fish, chicken, asparagus spears or fish cakes.

- Wash the cress, shake dry and chop roughly.
- Gently cook the shallot or onion in the butter or oil for 3 minutes until just softened, add the cress and cook for 2-3 minutes until wilted.
- Pour in the wine, if liked, and cook a few seconds then stir in the cream or crème fraîche
- Season with salt and pepper and simmer for 3-4 more minutes. Using the Dualit hand blender, whizz to a smooth purée.
- Check for seasoning and add lemon juice if using single cream (this will thicken the sauce slightly). Cover and keep warm for up to 10 minutes so it keeps its lovely bright green colour

AVOCADO SAUCE SERVES 6 TO 8

- 2 large avocado pears
- 3 shakes of Worcestershire sauce
- 5 tbsp Greek set yogurt
- 1 tsp lemon juice
- Salt and pepper

The Dualit hand blender brings out the best qualities of the smooth flesh of a ripe avocado. Its soft, buttery miniature makes it ideal for a quick sauce to accompany a piece of cold salmon.

A trick to retain the green colour of an avocado sauce is to keep it out of contact with the air. Always serve it as soon as possible, but meanwhile store it in a tall beaker, or similar shaped container, and cover with cling film touching the surface to exclude as much air as possible.

- Place avocados, Worcestershire sauce and yogurt in a large bowl, and blitz until smooth.
- Add salt and pepper and lemon juice, to taste, and whizz again to incorporate.
- Serve as soon as possible.

RED PEPPER MAYONNAISE SERVES 6

- ½ jar sweet red peppers, or peppadews
- 2 tsp brandy
- 100 ml double cream, whipped, optional
- 2 –3 tsp tomato ketchup
- 200ml thick mayonnaise or aioli
- Lemon juice to taste
- 2 tsp Worcestershire sauce
- Salt, pepper, paprika, Tabasco

This is easy to make, especially as you can buy sweet peppers and the little spicy peppadews in glass jars. It makes an excellent dressing for summer cold fish salads, or as a dip. (Serves six to eight).

- Drain and dry the peppers thoroughly.
- Place them in a bowl with the next six ingredients, and blitz until smooth.
- Add lemon juice to taste, and whizz again.

ONE PAN RELISH I SMALL JAR

- 180g cherry tomatoes
- 2 garlic cloves
- 2 red onions, halved
- 120g brown sugar
- 1/2 chilli, deseeded
- Juice of 1 whole lemon
- 70g red roasted peppers- 1 x Capsicum or 1 x Romano cut into several pieces
- 3 tbsps red wine vinegar
- Black pepper and Paprika to season

This delicious relish is so easy to make, with Dualit's Hand Blender chopper offering a speedy solution to a once-lengthy job. Enjoy with a slice of homemade bread or as part of a ploughman's lunch.

Roast pepper first if desired for a denser, smoky flavour.

- Place the tomatoes, red onion and peppers into Dualit's Hand Blender chopper bowl. Attach the power unit and switch on.
- Use the feeding tube to insert the garlic cloves into the chopper bowl, taking care to keep fingers and implements out of the feeding tube. Chop to your desired consistency – we like ours chunky.
- Place the brown sugar, vinegar and lemon juice and feed tube into a small bowl and stir into a paste.
- Place the chopped ingredients and the paste into a pan, season with black pepper and paprika and stir until the chopped ingredients are well coated.
- Simmer for 30-40 minutes until the relish takes on a jam like consistency.
- Pour into a sterilised jar and cool before moving to the fridge.
- Serve as and when required. It should keep for up to one month if stored in the fridge.

Alternatives:

- Add dried mango pieces to the mixture.
- Use lime instead of lemon juice.
- Try using curry paste or powder.

PEANUT & CHILLI SATAY SAUCE I MEDIUM JAR

- 1 – 2 large fresh red chillies
- 2cm cube fresh ginger, roughly chopped
- 1 tsp soft brown sugar | 1 tbsps Thai fish sauce or soy sauce
- 4 tbsps olive or groundnut oil
- 1 tsp ground coriander
- Juice of 1 lime
- 2 large shallots or 1 onion, roughly chopped
- 1 tsp ground cumin
- 4-5 tbsps coarse peanut butter
- 3 fat cloves garlic, chopped

This is delicious as a dipping sauce for chicken or prawn barbecue satays. It can also be used as a base for a Thai curry – use a couple of tablespoons per serving and dilute with some hot water.

- Slit open the chillies and discard the seeds and stalks. Roughly chop the flesh
- Heat the oil in a pan and sauté the chillies with the shallots or onion, garlic and ginger for about five minutes until softened.
- Add spices, sugar, fish sauce or soy and 200ml (7fl oz) water. Bring to the boil and simmer for 3 minutes. Remove from heat.
- Stir in lime juice and grind to a smooth paste with the Dualit hand blender.
- Stir in the peanut butter and heat until smooth and then dilute with 100ml (3½ fl oz) more water.
- When cool, scoop into a lidded jar. The sauce can be stored in the fridge for up to ten days.

SPICY DISHES

SWEET POTATO MASH WITH FIVE SPICE DUCK LEGS SERVES 2

- 2 Gressingham duck legs
- 1 large sweet potato, about 400g
- coriander or parsley
- 1 tsp Chinese five spice powder
- A good knob of butter
- Freshly ground black pepper
- 1 tsp sea salt crystals
- 1 tbsp chopped fresh

Healthy sweet potato (perfect for low GI diets) makes a deliciously satisfying mash. Its slight sweetness makes it an excellent accompaniment to roasted spicy duck legs. Make the mash while the duck is cooking.

- Preheat oven to 180C/350F/M4.
- Prick the duck legs well so the fat can escape during cooking.
- Mix together the spice and salt and rub half into the duck skin.
- Roast in a shallow dish for 30 minutes, pouring off the excess fat halfway through.
- Meanwhile, peel the potato, cut into chunks and boil for 10-12 minutes until just tender. Drain and return to the pan with the remaining spiced salt and butter.
- With the Dualit hand blender, whizz to a smooth purée. Season with pepper and stir in the chopped herbs.
- Serve the cooked legs on a bed of the mash with some pan juices drizzled over the top.

FRESH GREEN CURRY PASTE SERVES 4

- large fresh green chilli
- 1 cube fresh root ginger, approximately 3cm
- 2 fat cloves garlic, peeled and roughly chopped
- A small bunch (40g) of fresh coriander, with stalks
- 3 tbsp vegetable oil
- 2 tbsps coconut cream, optional, but nice
- 2 tsp ground coriander
- 1 tsp ground cumin
- 1 tsp ground fenugreek, if available
- 1 tbsp fresh lemon juice
- Salt and freshly ground black pepper

Use your Dualit hand blender to make a fresh and aromatic curry paste (enough for a curry for four) which can be stirred into a stir-fry of chicken, salmon or prawns for a delicious quick meal.

- Slit open the chilli, remove the seeds and stalk then roughly chop and place in a medium sized bowl.
- Roughly chop the ginger (no need to peel) and add into the bowl along with the garlic and half the oil.
- Snip in the coriander stalks but reserve the leaf sprigs.
- Pulse with the Dualit hand blender to a chunky purée then add the remaining oil, coconut cream, if using, ground spices, lemon juice and some salt and pepper.
- Whizz until smooth then add the coriander sprigs and pulse for a few seconds to incorporate
- Scoop the mixture into a lidded jar and keep in the fridge until required.

TO MAKE THE CURRY

The paste makes enough for 3-4 chicken breasts or salmon steaks, or 400g of peeled prawns.

- To make the curry, stir fry the chicken breasts (chopped), the salmon (cubed), or the prawns in a little hot oil for 2-3 minutes (the chicken will take longer than the fish – about 6-8 minutes, depending on the size of the pieces) then mix in the curry paste.
- Stir well, cook for 2-3 more minutes and add a small cup of water to thin a little.
- Simmer for a couple more minutes and serve straight away with steaming basmati rice.

DESSERT

EXOTIC FRUIT JELLIES SERVES 2

- 2 ripe passion fruits
- 1 ripe pomegranate
- 4 juicy oranges
- 1 - 2 tsp flower honey
- 2 sheets leaf gelatine or 1½ tsp powdered gelatine
- Cream or natural yogurt, to serve, optional

Passion fruits and pomegranates add an exotic flavour when combined with other juices but the seeds can get in the way. This can be solved by pulping them with the Dualit hand blender and then straining the juice.

For best flavours choose well ripened fruits and blood oranges (when in season) which give a glorious colour to the jellies.

- Halve the passion fruits and pomegranates. Scoop the passion seeds into a medium bowl.
- Break the pomegranate halves into sections, peel off the membranes and add the seeds to the bowl.
- Blitz the seeds to a juicy pulp with the hand blender, and then rub through a sieve into a pan.
- Top and tail one of the oranges and slice off the skin and pith, then chop the fruit into small chunks, removing any pips.
- Divide these between two large wine glasses. Squeeze the juice from the other oranges and add to the pomegranate and passion fruit juice.
- You should have around 250ml (9fl oz) juice. If not, top up with some water. Add the honey
- Soak the leaf gelatine in cold water to cover until floppy then tip out the water.
- If using powdered gelatine, mix with 2 tablespoons cold water and leave to soak.
- Heat the juice until on the point of boiling, remove and slide in the soaked gelatine, stirring until dissolved.
- Cool then pour over the chopped fruits and leave to set in the fridge.
- Serve with cream or yogurt spooned on top.

WHIPPING CREAM

- 285 ml chilled double cream

The hand blender whips double cream perfectly.

Why not try whipping cream, this is a lighter version of double cream, it whips beautifully without being quite so rich.

- Use a deep bowl with steep sides.
- Blitz, with the hand blender, in the centre of the cream, until thickish.
- Then with a fork, stir in the liquid cream from round the sides, until all is thick.
- This takes about a minute.

FROTHY CRÈME ANGLAISE SERVES 5

- 250ml milk
- 250ml double cream
- 1 vanilla pod or
- 1 tsp vanilla extract
- 6 egg yolks (or 1 egg and 2 yolks)
- 75-90g caster sugar

Real homemade custard is so wonderfully comforting. Give it a neat twist by whisking it to cappuccino froth and turn a homely pudding into a luxury dessert.

- Pour the milk and cream into a non-stick saucepan. Slit the vanilla pod in half (if using) and scrape out the sticky seeds with the tip of a sharp knife. Add to the pan, with the split pod
- If using vanilla extract, simply pour in.
- Heat the creamy milk until on the point of boiling, cool for 10 minutes and then remove the pods
- Meanwhile, place the yolks and sugar in a heat-proof bowl and using the Dualit hand blender whizz until thick and creamy.
- Return the milk to the heat and bring back to the point of boiling.
- Using a wooden spoon, gradually beat the milk into the sugary egg yolks then return to the pan
- Turn the heat to low and stir the custard for a few minutes until it begins to thicken slightly and coats the back of the spoon like thin cream.
- Don't let it overheat because it will curdle. Pour through a sieve back into the bowl, cover and cool 10 – 20 minutes.
- When ready to serve, whizz with the hand blender until you get a nice frothy mixture.
- Serve immediately.

BERRY FRUITS AND HONEY ICE CREAM DRIZZLE (SERVES FOUR)

- 150g blueberries or mixed berries
- 150g fresh raspberries
- 4-6 strawberries, chopped
- 1 tbsp flower honey
- Squeeze fresh lemon juice
- 1 tbsp whisky or crème de cassis (optional)
- Ice cream and ratafia biscuits, to serve

Turn shop bought ice cream into a luxurious dessert with this fruity sauce. Variations in fruits and alcohol can completely transform the recipe, experiment with the contents of your fruit basket.

- Put all the fruits into a saucepan with 2-3 tablespoons water and heat until the juice starts to run.
- Stir in the honey and simmer 2-3 minutes until just softened and the berries break down.
- Remove from the heat and whizz with the Dualit hand blender until smooth.
- Rub the pulp through a sieve into a jug.
- Mix in the lemon juice and whisky or Cassis, if liked.
- Cool and chill until required.
- To serve: put scoops of luxury ice cream into 4 sundae dishes. Good flavours to choose from are vanilla, mango, coconut, caramel, strawberry or raspberry.
- Drizzle with the sauce then crush over some ratafia biscuits.

GUARANTEE

This appliance is of excellent quality and construction. However, if any defects in materials or workmanship do appear during the relevant guarantee period, we will, at our discretion, either repair or replace the defective parts, free of charge, subject to the terms and conditions of our Guarantee shown below.

This Guarantee covers both parts and labour. Carriage is not included.

Your Guarantee period is as follows:

- 1 year

This Guarantee provides benefits which are additional to, and do not affect, your statutory rights. This Guarantee does not cover the cost of returning the product to the dealer from whom it was purchased or to ourselves. This Guarantee applies only to products sold and located in mainland Great Britain. It does not cover liability in respect of or replacement of plugs, cables or fuses and also does not cover defects due to:

- Failure to use or maintain product in accordance with Dualit's instructions.
- The product being connected to an unsuitable electricity supply.
- Accidental damage to or abuse or misuse of the product.
- product modification, except by Dualit or approved agent.
- Dismantling of or interference with the product.
- Theft or attempted theft of the product.

Before returning any product under this Guarantee, please check that:

- You have followed the product instructions correctly.
- Your mains electricity supply is functional.
- The defect is not due to a blown fuse.

If you wish to claim under this guarantee you should:

- Send the product, postage or carriage paid, to the dealer from whom it was purchased or to Dualit direct.
- Ensure that the product is clean and packed carefully (preferably in its original carton).
- Enclose details of your name, address and telephone number and when and where the product was purchased, together with proof of purchase (e.g. a till receipt).
- Give exact details of the nature of the defect.

This Guarantee does not cover any other claims whatsoever, including, without limitation, any liability for incidental, indirect or consequential damage, nor does it cover any claims for conversion or modification or for the costs of repair carried out by any third party without the prior consent of Dualit. If replacement parts are fitted to the product this will not extend the period of the Guarantee.

For further advice contact the Dualit customer helpline on +44 (0) 1293 652 500 (09:00 to 17:00 Monday to Friday).

Alternatively, email Dualit at info@dualit.com or visit www.dualit.com

Do not throw away the appliance with the normal household waste at the end of its life, but hand it in to an official collection point for recycling. By doing this you help preserve the environment.



CLUB
Dualit.



Join Club Dualit
For recipes, video guides, cooking tips and more...



WWW.DUALIT.COM/RECIPES

Dualit®

Dualit Limited County Oak Way Crawley West Sussex RH11 7ST
t: +44(0)1293 652 500 f: +44(0)1293 652 555 e: info@dualit.com

GB-C