

**COLD GASTRO BUFFET
INSTRUCTION MANUAL
BB3-COLD-WE, BB4-COLD-WE, BB5-COLD-WE**



CONTENTS

1. AIMS AND SCOPE
2. RESPONSIBILITIES
3. SIGNS
4. TECHNICAL DATA (BASIC FEATURES)
5. TRANSPORTATION AND INSTALLATION
6. GENERAL PRINCIPLES
7. INFORMATIONS AND EQUIPMENTS RELATED TO PRODUCT
8. DESCRIPTION OF DEVICE WITH EXPLANATIONS
9. REPLACING THE DEVICE AND PREPARING FOR START UP
INSTALLATION BEFORE ASSEMBLING
PREPARATION FOR START UP
FINAL CHECK BEFORE START UP
10. START UP
11. MAINTENANCE AND CLEANING
DAILY MAINTENANCE AND CLEANING
WEEKLY MAINTENANCE AND CLEANING
12. SAFE LIFE
13. INTERVENTION AFTER FAILURE
14. SPARE PARTS LIST

1. AIMS AND SCOPE





Descriptions for safe use and maintenance of the product

2. RESPONSIBILITIES

Responsibilities of Product's Owner: The product's owner is responsible for applying of safety rules stated in this Instruction Manual or getting them applied by delegating his authorities and risks, which may arise due to not applying. The product's owner is also responsible for the periodical maintenance of the machine.

Responsibilities of the Manufacturers: The manufacturer is responsible for the risks due to manufacturing and assembling faults, even though all requirements stated in this manual have been fulfilled.





3. SIGNS

	WARNING: This sign indicates that it must be complied with the instructions related to the subject; otherwise, the risky conditions, in which there can occur some damages and dangers
	CAUTION: This sign indicates any risky conditions, which can cause damages in material and injuring of people, provided that one does not pay attention and states that one must be careful.
	DANGER: This sign indicates high risky conditions in which people can be injured, provided that one does not pay attention and the rules always to be complied with.
	DANGER: This sign indicates high risky conditions in which the people can be injured or can die due to electrical shock.
	Equipotential connection terminal (If necessary, it must be connected to other equipment to make equal the potential)



















4. TECHNICAL DATA

MODEL	DIMENSION (mm)	CURRENT	POWER SUPPLY	CABLE (mm ²)	GROSS kg	GROSS M3	GAS	CLASS
BZ-BB3-COLD	1250x800x1355	3.5 A	220 - 230V 50Hz	3X1,5	175	1,19	R 134 A 230 gr	N
BZ-BB4-COLD	1570x800x1355	3.5 A	220 - 230V 50Hz	3X1,5	200	1,48	R 134 A 250 gr	N
BZ-BB6-COLD	1890x800x1355	3.5 A	220 - 230V 50Hz	3X1,5	252	1,80	R 134 A 280 gr	N

5. TRANSPORTATION AND INSTALLATION

	<p>During transportation, take necessary precautions against the risk of falling down and being turned upside down for the product.</p>
	<p>Place the product onto a flat and solid ground.</p>
	<p>Do not install the product near the flammable and explosive materials and do not keep any flammable and explosive material near the furnace, while it is working.</p>
	<p>Keep surely a fire extinguisher near the furnace and check whether the periodical checking of the fire extinguisher has been implemented or not.</p>

6. GENERAL PRINCIPLES

-  The users agree and accept to be in conformity with all requirements included in using manual, otherwise the machine shall be deemed OUT OF GUARANTEE COVERAGE.
-  The user also accepts that he/she was fully informed about the limited guarantee liability.
-  Any living body or any object should not be placed on machines. In addition, any living body should not be put inside the machines.
-  It should not be allowed the children or any other unauthorized persons to operate the machines.
-  Any electrical operating machines should be cleaned after the required electrical connections switched off.
-  The electrical products should never be operated if any sufficient grounding installation had not been practiced in addition; the LEAK CURRENT RELAY and fuse groups had not been installed in control box supplying the electrical energy to the machine.
-  The cover of any machine should not be opened during the period of working.
-  Be careful not to squeeze your hands while closing the covers.
-  The machines and covers should not be treated as step or ladder in any case.
-  The electrical devices should never be washed in the manner of spraying water. They should be cleaned by means of rubbing after switching the power off the power had been switched off.
-  Any scratchier or stripper tools should not be used during the cleaning.
-  This manual verifies all machines were tested and the required security controls were done in due diligence so delivered under operating conditions.
-  Use rubber gloves during the cleaning and maintenance practices procedures
-  Do not remove the labels and panels of the devices.
-  In order to ensure efficient operation of the machines including electrical water heating process and to minimize the energy costs, you should provide the machine with 50 °C water. In addition, softened water under 15 °Fr hardness should also be used to expand the life of your machines. If you do not have such required softened water then you should use a separate water softener device.
-  The manufacturer shall not be responsible for any possible printing mistakes included in both manual and machine introduction leaflet.
-  The manufacturer reserves the right to make any modification or amendments partially or entirely on any part of machine, if it considers necessary or beneficial or to be in favor of user or product without any previous notification. Besides, the producer guarantees that the fundamental functionality and security specifications of the machines should also be kept as required
-  In the event of any fault, switch off all electric/Water connections then apply to the authorized service staff.

T The electric connection must be disconnected before changing the lamp. Change the lamp with same MODEL 2 x 60 W Philips Philinea

T Power cord must be min. Ordinary polyvinyl chloride sheathed cord (IEC 60227-IEC 52)

T Cable diameter must be min. :SBM4 : 3x1.5 mm²

T Grounding line must be continuously checked.

7. INFORMATIONS AND EQUIPMENTS RELATED TO PRODUCT

A. Description Catalogue

B. User/Maintenance/Assembling Manual

Dear Customers, please check the above written auxiliary equipment to be given with the machine on delivery. If you notice any damage or loss occurred during the transportation then you should request the transporter to issue any written report including the relevant damage or loss.

8. DESCRIPTION OF DEVICE WITH EXPLANATIONS

The device have wholly manufactured regarding to hygienic standards.

Outside, inside and all surfaces contacting to the food of the device have been manufactured completely AISI 304 (Cr-Ni 18/10) stainless steel material.

The legs are in adjustable feature and manufactured by stainless steel material.

For the insulation purposes, glass- wool and stone-wool have been used. Thanks to this application, wasting of energy can be able to prevent.

Electrical operated devices have been secured completely by means of thermal and electrical relays.

Accesses to control panel, maintenance and checking have been facilitated.

Electrical components and cable are complied with the relevant standards.

9. REPLACING THE DEVICE AND PREPARING FOR START UP

INSTALLATION BEFORE ASSEMBLING

T Open the packing of the device and remove all protective tapes.

T Opening the cover of the device, take out the instruction manual.

T Place the devices with adjustable legs by adjusting their legs and the device with fixed legs by aligning the ground.

T Make the grounding connection thoroughly.

T Be sure that the energy supplied.

T Authorized and certificated people must make all these connection.

T Now, your device is ready for use.

PREPARATION FOR START UP

T Assuming that electrical installation connections have already made by competent technicians, the user must implement the following simple inspections

T Be sure that in electrical operated devices, the electricity current has been supplied in adequate features as stated in TECHNICAL DATA catalogue and grounding connection has been complemented. .

T Read the instruction and maintenance manual absolutely.

FINAL CHECK BEFORE START UP

○ The users should fulfill the following last-controls by accepting the required couplings of fresh water, electric, wastewater , installations to be carried out by the authorized technicians;

○ You must be sure that the power supply and grounding installation are ensured as required in leaflets of electrical equipment.

○ You must be sure that the feeding water has been installed and the water vane is turned on.

○ You must be sure that the wastewater installation was done properly and discharging hose was coupled with discharging pipe tightly.

10. START UP

- I** The figures of control panel on the devices have been shown. According to these figures, as earlier mentioned, the device, whose electrical connection was made fully and correctly, is operated by turning on control switches.
- I** Adjust the thermostat to the desired temperature.
- I** While the devices are in operation, do not keep burning material (plastic bags, table napkin, clothe etc.) near them.

CONTROL PANEL

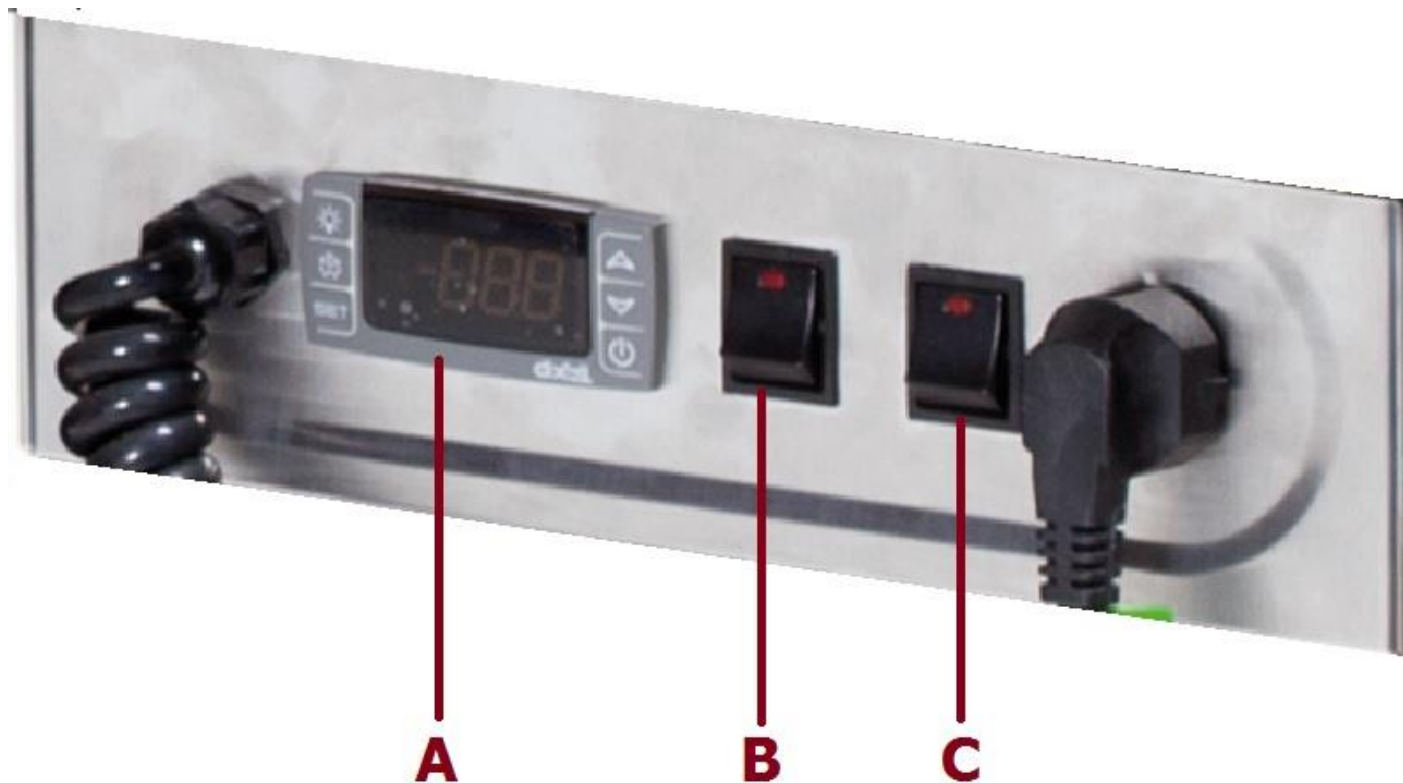

A- DIGITAL THERMOMETER

B- ON/OFF SWITCH

C- LAMP ON/OFF SWITCH

11. MAINTANCE AND CLEANING

Implement the following periodical maintenance so that the product should work in safe and long life

DAILY MAINTANCE AND CLEANING

- Device must be cleaned every day after use, after being sure that it is completely cooled down.
- Cleaning must be made by a clean wet cloth by wiping the device. It is recommended that stainless steel surfaces should be wiped by inox cleaners.

WEEKLY MAINTANCE AND CLEANING

- During cleaning, do not use sharp edged, cutting and drilling tools such as scraper, emery in no way.
- Cleaning must not be done by spraying the water onto the device in no way.
- If the device is used together with another device side by side, both devices must be cleaned parting them from their jointed places without damaging the electrical connections.

12. SAFE LIFE

The safe life of the product is 5 years.

13. INTERVENTION AFTER FAILURE

FAILURES / CAUSES

- There is no colding.
 - 1) Be sure that the energy supplied to the device.
 - 2) Be sure that thermostat is open.

14. SPARE PARTS LIST

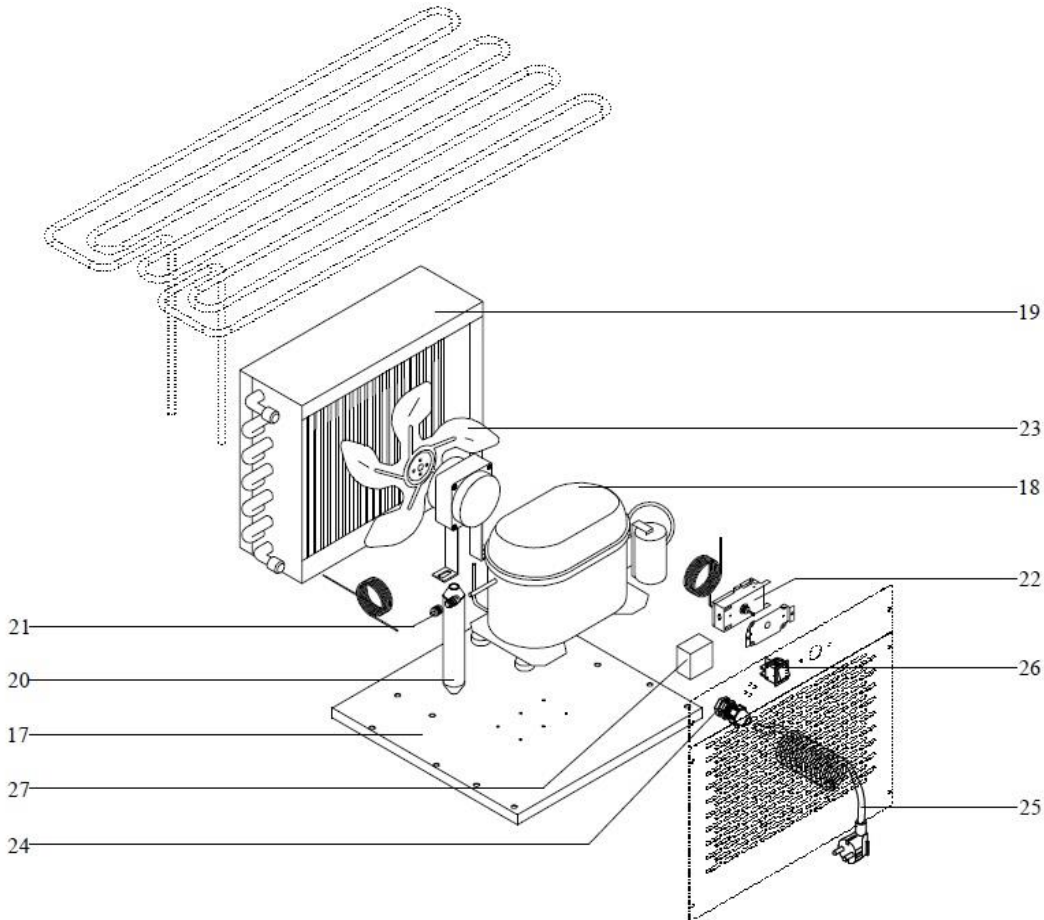

NO	DESCRIPTION
17	Frame
18	Fridge Motor
19	Condenser
20	Drier
21	Tappet
22	Thermostat
23	Fan Motor
24	Fitting
25	Cable
26	On/Off Switch
27	Holder

