

BURCO

COMMERCIAL

Users Guide & Installation Handbook

CONTENTS & INTRODUCTION

CONTENTS

- SAFETY
- USING THE PRODUCT
- CLEANING
- INSTALLATION INSTRUCTIONS
- TECHNICAL DATA
- CUSTOMER CARE

INTRODUCTION

Thank you for buying this British-built appliance from us.

This guide book is designed to help you through each step of owning your new cooker, from installation to use. Please read it carefully before you start using your product, as we have endeavored to answer as many questions as possible, and provide you with as much support as we can.

If, however, you should find something missing, or not covered, please contact our Customer Care team. Their number is located on the back page of this book.

For customers outside the UK and Northern Ireland, please contact your local supplier.

When you dial this number you will hear a recorded message and be given a number of options. This indicates that your call has been accepted and is being held in a queue. Calls are answered in strict rotation as our Customer care representatives become available.

Alternatively, general information, spares and service information is available from our website. The address is located on the back page of this book.

WARRANTY

Your new appliance comes with our 3-years parts and 1 years labour guarantee, protecting you against electrical and mechanical breakdown. To register your appliance please call **0844 815 3742**, complete the registration form included or register online at the web address located on the back page of this book.

For full terms & conditions of the manufacturer's guarantee, refer to the website on the back of this book.

Our policy is one of constant development and improvement, therefore we cannot guarantee the strict accuracy of all of our illustrations and specifications - changes may have been made subsequent to publishing.

SAFETY

BEFORE USING THE PRODUCT

Make sure that you have removed all packaging and wrapping. Some of the items inside this appliance may have additional wrapping.

It is advised that you turn the ovens and/or grill on for a short while. This will burn off any residues left from manufacturing. There may be a smell which accompanies this process - but this is nothing to worry about and is harmless.

It is recommended that you wash the oven shelves, baking tray, grill pan and grill pan trivet before their first use in hot soapy water. This will remove the protective oil coating.

Caution: This appliance is for cooking purposes only. It must not be used for other purposes, for example room heating.

WARNING: - The appliance and its accessible parts may become hot during use. Care should be taken to avoid touching heating elements. Children less than 8 years of age shall be kept away unless continuously supervised.

This appliance can be used by children aged 8 years and above and persons with reduced physical, sensory or mental capabilities or lack of experience and knowledge if they have been given supervision or instruction concerning use of the appliance in a safe way and understand the hazards involved. Children should

not play with the appliance. Cleaning and maintenance shall not be made by children without supervision.

WARNING:- Servicing should be carried out only by authorised personnel.

The appliance must never be disconnected from the mains supply during use, as this will seriously affect the safety and performance, particularly in relation to surface temperatures becoming hot and gas operated parts not working efficiently. The cooling fan (if fitted) is designed to run on after the control knob has been switched off.

SAFETY

GENERAL

or items in the vicinity of this appliance.

OVEN/GRILL

- Do not modify this appliance.

Do

- Always take care when removing food from the oven as the area around the cavity may be hot.
- Always use oven gloves when handling any utensils that have been in the oven as they will be hot.
- Always make sure that the oven shelves are resting in the correct position between two runners. Do not place the oven shelves on top of the highest runner, as this is not stable and can lead to spillage or injury.
- Always use the Minute Minder (if fitted) if you are leaving the oven unattended - this reduces the risk of food burning.

Do Not

- Never place items on the door while it is open.
- Never wrap foil around the oven shelves or allow foil to block the flue.
- Never drape tea towels near the oven while it is on; this will cause a fire hazard.
- Never pull heavy items, such as turkeys or large joints of meat, out from the oven on the shelf, as they may overbalance and fall.
- Never use this appliance to heat anything other than food items and do not use it for heating the room.
- Do not spray aerosols in the vicinity of this appliance while it is in operation.
- Do not store or use flammable liquids

SAFETY

ELECTRIC HOB

WARNING:- Unattended cooking on a hob can be dangerous and may result in fire. NEVER try to extinguish a fire with water, but switch off the appliance and then cover flame e.g. with a lid or a fire blanket.

Danger of fire: do not store items on the cooking surface.

If the surface is cracked, broken or shattered, switch off the appliance to avoid the possibility of electric shock and call for a service engineer's visit.

GENERAL

Do

- Always ensure that pan bases are dry and flat before using them on the hob.
- Always position pans over the centre of the heat zone, and turn the handles to a safe position so they cannot be knocked or grabbed.
- Always use pans which are no smaller than 100mm (4"), or no larger than 250mm (10").
- Always match the size of pan to the size heat zone – do not use large pans on small zones or vice versa.
- Always lift pans onto and off the hob, rather than sliding them across the surface, to avoid marks and scratches.

- If the appliance has solidplate elements, prime and season your hob before using it for the first time - see the Care & Cleaning section.

Do Not

- If the appliance has a glass hobtop, never drag pans across the ceramic surface as this will lead to scratches and damage.
- Never use double pans, rim-based pans, old or misshapen pans, or any pan that is not stable on a flat surface.
- Never leave cooking fat, or oil, unattended.
- Never use commercial simmering aids, or heat diffusers, as they create excessive heat and can damage the surface of the hob.
- Never use the hob for any other purpose than cooking food.
- Plastic cooking utensils can melt if they come into contact with a warm hob. Never leave them close to, or on top of the hob.
- Never leave any cook zone on without a pan covering it. This causes a fire hazard.
- Never use the hob surface as a chopping board or food preparation area, as this may lead to it becoming damaged.

SAFETY

Do Not

- Never put metal cooking utensils, cutlery, knives or other metal objects on the hob. They could become hot if they are near a cooking area which is in use.
- Never leave pans overhanging the edge of the hob. The surface of the hob is smooth. If pans are knocked they may move on the hob top.
- If the appliance has solidplate elements, never leave pan lids or decorative covers on top of the elements as any trapped moisture will lead to corrosion.
- Never stare at the halogen elements (if fitted). This may impair your vision.
- Never leave aluminium foil on the hob top, it reflects heat back into the element which leads to damage. Never heat up a sealed tin of food on the hob, as it may explode.

FIRE SAFETY ADVICE

Most kitchen fires occur when people are distracted or leave things unattended, so remember:

If you're called away from the cooker - by the phone or someone at the door, either take pans off the heat, or switch off your hob.

Don't let yourself be distracted while cooking.

If you do have a fire in the kitchen, don't take any risks - get everyone out of your home and call the Fire Brigade.

If a pan catches fire:

- Do not move it - it is likely to be extremely hot.
- Turn off the heat if it's safe to do so - but never lean over a pan to reach the controls.
- If you have a fire blanket, put it over the pan.
- If you have put the fire out, leave the pan to cool completely.

Deep-fat frying presents more dangers in your kitchen.

- Never fill a chip pan (or other deep-fat fryer) more than one-third full of oil
- Do not use a fire extinguisher on a pan of oil - the force of the extinguisher can spread the fire and create a fireball.

If you have an electrical fire in the kitchen:

- Pull the plug out, or switch off the power at the fuse box - this may be enough to stop the fire immediately
- Smother the fire with a fire blanket, or use a dry powder or carbon dioxide extinguisher
- Remember: never use water on an electrical or cooking oil fire.

USING THE HOB - ELECTRIC (CERAMIC)

Warnings

- Do not use the ceramic hob if the glass surface is cracked, as electrical parts are directly beneath. Switch off the appliance at the supply to prevent electric shock and contact your supplier.
- The hob surface remains hot after use. DO NOT TOUCH.

Using Rotary Controls

- Select the element you wish to use, place the pan on and turn the control knob to the power setting you wish to use.
- To switch off, turn the selected control knob to the 'off' position.

Notes on use

- The power settings on the hob do not indicate any set temperature and cannot be used to judge one element against another.
- During cooking, the elements will cycle on and off. This is to prevent the hob from overheating.
- Pans should not be allowed to come into contact with coloured trims during use as this may cause discolouration of the surface

Hot Hob Warning (if fitted)

The surface of the hob gets hot in use. Your hob may have:

- The word "hot" written on it, as a cautionary note that the surface will become hot during use.
- The word "hot" written on it, with the addition of a light beneath it. This light will illuminate when any element is used and remains lit for a while after all elements have been switched off to show that the surface may still be hot to touch.

USING THE GRILL - ELECTRIC

WARNING:- The vents on the grill canopy are there to allow heat escape. Items MUST NOT be placed on top of the grill canopy.

Accessible parts may be hot when the grill is used. Young children should be kept away.

General

Your double grill has full variable control and both the left hand and right hand grills are independent of each other. This allows you to use either the left hand or right hand grill individually or both together.

Fitting the grill pans

Make sure that the grill pan is first pushed back to the rear stop position and engage onto the grill pan runners before pulling forward to the front stop position.

Removing the grill pans

Push the grill pan along the grill pan runners back to the rear stop position. lift off and remove.

Preheating

Always preheat the grill for about 3 to 5 minutes, for best cooked results.

Grilling

The temperature of both grills is variable, and can be adjusted by turning the grill control to the required setting. Grilling can also be adjusted by use of the trivet - there are three different grilling positions, as the grill trivet, which is in the grill pan, may be inverted to give a high or low position or the trivet may be removed, as detailed below: -

1. The HIGH trivet position is suitable for toasting bread.
2. The LOW trivet position is suitable for grilling all types of meat & fish.
3. With the grill trivet removed the food is placed directly on the base of the grill pan, eg; when cooking whole fish or browning dishes such as cauliflower cheese.

Food for grilling should be positioned centrally on the trivet & the grill pan should be pushed fully in to its stop position.

Never allow fat to build up in the grill pan as this creates a fire hazard.

If cleaning the grill pan when it is hot, use oven gloves to move it.

When you have finished grilling, check that both the control knobs are returned to the 'off' position.

Aluminium foil

Using aluminium foil to cover the grill pan and/or trivet, or putting items wrapped in foil under the grill can create a fire hazard; also, the high reflectivity of aluminium foil can damage the grill element.

USING THE OVEN - SLOW COOK (if fitted)

WARNING:- Accessible parts may become hot during use. Young children should be kept away.

Introduction

One of your oven compartments is an electric oven which provides a gentle heat suitable for slow cooking or keeping food warm.

The slow cook element is positioned in the base of the slow cook compartment- always make sure that the prepared cooking pot is placed centrally on the base of this compartment.

Do not use any compartments to store food or canned items.

Cooking times

The cooking time varies according to the type of food being cooked, and experience will show how long foods should be cooked for, according to personal taste and preference.

In general foods should be cooked for at least 5 hours, and maybe left up to 8-10 hours without spoiling if covered. As a guide, foods cooked using the slow cook oven will take about three times longer than they would in a conventional oven.

Utensils

Any oven proof utensils maybe used for slow cooking, provided they have a close fitted lid.

To rectify a badly fitting lid a piece of cooking foil may be placed over the dish, under the lid.

For convenience and to save washing up, the most useful utensils for slow cooking are the flame proof type which can be used over direct heat and for oven

cooking, and are sufficiently attractive to use as serving dishes.

Keeping food warm

Turn the oven on, and allow to pre-heat for 20 minutes before placing the food in the oven. If food is to be kept moist then it is important to cover the dish or plate to prevent food from drying out. This can be done using aluminium foil if the dish does not have a lid.

Do not use cling film to cover food as it cannot withstand the heat produced in the oven.

Some foods are best left uncovered if you wish to keep the food dry and crisp.

Do not add gravy to plated meals until serving.

Carved meat should be placed on one plate and covered, adding just one tablespoon of gravy to keep it moist. When keeping plated meals warm it is recommended that the food is placed on hot rather than cold plates.

Slow Cooking

Slow cooking has always been the best way to prepare a nutritious hot meal with the minimum of preparation and maximum time away from the kitchen. The benefits of slow cooking have been recognized by cooks for centuries, and are still appreciated by cooks today.

USING THE OVEN - SLOW COOK (if fitted)

The advantages of slow cooking are as follows:

- Food can be left to cook unattended for several hours and will keep hot for several hours if left covered, without spoiling for a further 2-3 hours, so foods can be left to cook while you are out for the day, or over night.
- Inexpensive cuts of meat become deliciously tender when slow cooked.
- Slow cooking will also produce moist, tender "roasts" with minimal meat shrink-age and reduced oven soiling.
- Dishes such as soups, vegetables, puddings savory dishes and preserves are also suitable for slow cooking.
- There is no topping up of steamers, steam filled kitchens or constant checking to do.

Using the slow cook oven

Turn the oven on and preheat for 20 minutes. Always place the prepared cooking pot centrally on the base of the oven. Follow the guide lines for the best results.

- The maximum capacity of oven proof dishes should be no more than 2.5 litres (4.5 pints).
- Please note: The more you fill the dish/pot the longer it will take to cook.
- Cooking times will vary depending on the size and shape of the meat, or poultry.
- Always bring soups, casseroles and liquids before placing in a preheated oven. To give more colour to meat or poultry, fry the meat to brown and add to stock which is hot.
- All meat and poultry recipes need a minimum of 5 hours to cook.
- Make sure all frozen ingredients are

well thawed out.

- Always ensure that frozen poultry has thoroughly defrosted in a refrigerator and all ice crystals have melted.
- Cut root vegetables into smaller pieces as they take longer than meat to cook.
- If possible they should be sauteed for 2-3 minutes before slow cooking.
- Ensure that root vegetables are always at the bottom of the pan immersed in the cooking liquid.
- A meat thermometer should be used when cooking pork joints and poultry. The internal temperature of the food should reach 88 °C,
- Stuffed meat or stuffed poultry should not be slow cooked. Cook any stuffing separately.
- Cover casseroles with a lid, or foil to prevent loss of moisture.
- Adjust seasonings and thickenings at the end of cooking time.
- Dried red kidney beans must be boiled for a minimum of 10 minutes following soaking before inclusion in any dish.
- Opening the door during cooking, leads to heat loss, and will lead to increased cooking times.

USING THE MAIN OVEN - ELECTRIC

Accessible parts may be hot when the oven is used. Young children should be kept away.

To switch on the oven

Turn the oven control knob(s) to the required setting.

The red thermostat indicator (if fitted) will come on until the selected temperature is reached and then go off; it will turn on and off periodically as the thermostat operates to maintain the selected temperature.

To switch off, return the control knob to the "off" position.

When using the oven

As part of the cooking process, hot air is expelled through a vent in the oven. When opening the oven door, care should be taken to avoid any possible contact with potentially hot air, since this may cause discomfort to people with sensitive skin. We recommend that you hold the underneath of the oven door handle.

PREHEATING

Fanned oven

When cooking sensitive items such as soufflé and Yorkshire puddings or, when cooking bread, we recommend that the oven is pre-heated until the neon switches off for the first time. For any other types of cooking, a pre-heat may not be required.

Conventional oven

Preheating is always required

Manual Operation (fanned only)

The programmer must be set to manual operation before the main oven can be used. If A (Auto) is on the programmer display, return the oven to manual by pressing the up and down buttons simultaneously Any programme which has been set is cancelled.

The cooling fan

The cooling fan may operate when the main oven is on and may continue to operate for a period after the oven has been switched off.

OVEN FURNITURE

Oven shelves

The oven shelf must be positioned with the upstand at the rear of the oven and facing upwards.

Position baking trays and roasting tins on the middle of the shelves, and leave one clear shelf position between shelves, to allow for circulation of heat.

Baking tray and roasting tins

For best cooked results and even browning, the recommended size baking trays and roasting tins that should be used are as follows;

Baking tray 350mm x 250mm

This size of baking tray will hold up to 12 small cakes.

Roasting tin 370mm x 320mm

We recommend that you use good quality cookware. Poor quality trays and tins may warp when heated, leading to uneven baking results.

USING THE MAIN OVEN - ELECTRIC

Slow cooking (S) Setting or 100°C

- Make sure that frozen foods are thoroughly thawed before cooking.
- Do not slow cook joints of meat or poultry weighing more than 2¼kg/4½lb.
- Preheat the oven to 170°C and cook for 30 minutes, then adjust the oven control to (S) or 100°C (slow cook setting) for the remainder of the cooking time.
- Slow cooking times will be about 3 times as long as conventional cooking times.
- Do not open the oven door unnecessarily during slow cooking, as this will result in heat loss at low temperatures.
- Always use dishes with tightly fitting lids. To rectify badly fitting lids, place foil over the dish underneath the lid.

Aluminium foil

Use foil only to cover food or cooking dishes, using foil to cover the shelves or oven base creates a fire hazard.

Cooking with a fanned oven

As this is a high efficiency oven, you may notice the emission of steam from the oven when the door is opened. Please take care when opening the door.

If you are used to cooking with a conventional oven you will find a number of differences to cooking with a fan oven which will require a different approach:

There are no zones of heat in a fan oven as the convection fan at the back of the oven ensures an even temperature throughout the oven.

This makes it ideal for batch baking - eg; when planning a party as all the items will be cooked within the same length of time.

Foods are cooked at a lower temperature than a conventional oven, so conventional recipe temperature may have to be reduced. Please refer to the conversion chart.

Preheating is generally not necessary as a fan oven warms up quickly.

There is no flavour transference in a fan oven, which means you can cook strong smelling foods such as fish at the same time as mild foods - eg; milk puddings.

When batch baking foods that will rise during cooking - eg; bread - always ensure that enough space has been left between the shelves to allow for the rise.

Notes:

When 2 or more shelves are being used, it may be necessary to increase the cooking time slightly.

Because the 2 oven shelves are wider than in many ovens, it is possible to cook 2 items per shelf - eg; 2 victoria sandwiches or 2 casseroles.

Although you need to keep in mind the points 'To help the air circulate freely' with careful choice of dishes and tins, it is possible to cook a complete meal, and perhaps something else for the freezer, in the oven at the same time.

When roasting meats, you will notice that fat splashing is reduced, which is due in part to the lower oven temperatures, and will help keep cleaning of the oven to a minimum.

Because a fan oven has an even temperature throughout the oven, there is no need to follow the shelf positions given in the baking guide.

USING THE MAIN OVEN - ELECTRIC

There is no need to interchange dishes onto different shelves part way through cooking, as with a conventional oven.

To help the air circulate freely

Position the shelves evenly within the oven and maintain a clearance from the oven roof and base.

If more than one cooking dish or baking tray is to be used on a shelf, leave a gap of at least 25mm between the items themselves and the oven interior.

Defrosting and cooling in the main oven

To defrost frozen foods, turn the main oven control to the defrost position, place the food in the centre of the oven and close the door.

To cool foods after cooking prior to refrigerating or freezing, turn the main oven control to the defrost position and open the door.

Defrosting times

Small or thin pieces of frozen fish or meat - eg; fish filets, prawns & mince will take approximately 1 - 2 hours.

Placing the food in a single layer will reduce the thawing time.

A medium sized casserole or stew will take approximately 3 - 4 hours.

A 1½kg/3lb oven ready chicken will take approximately 5 hours, remove the giblets as soon as possible.

Be safe

Do not defrost stuffed poultry using this method.

Do not defrost larger joints of meat and poultry over 2kg/4lb using this method.

Never place uncooked food for defrosting next to cooked food which is to be cooled, as this can lead to cross contamination.

Defrosting meat, poultry, and fish can be accelerated using this method but make sure they are completely thawed before cooking thoroughly. Place meat and poultry on a trivet in a meat tin.

MAIN OVEN BAKING GUIDE

Cooking times & temperatures

The temperature settings and times given in the baking guide are based on dishes made with block margarine. If soft tub margarine is used it may be necessary to reduce the temperature setting.

Allow enough space between shelves for food that will rise during cooking.

Do not place items on the oven base as this will prevent air circulating freely.



USING THE MAIN OVEN - ELECTRIC

Note: this is a high efficiency oven, therefore some adjustment will have to be made to conventional cooking temperatures. The table below shows conventional cooking temperatures, 'A' efficiency temperatures and gas marks. For optimum results,

conventional temperatures need to be converted to 'A' efficiency temperatures.

For example, an item which would normally cook at a conventional temperature of 180 °C, will now cook at the 'A' efficiency temperature of 160°C.

Conventional temperature (°C)	'A' Efficiency Oven (°C)	Gas Mark
100	100	1/4
110	110	1/4
130	120	1/2
140	130	1
150	140	2
160	150	3
180-190	160	4-5
200	170	6
220	180	7
230	190	8
250	200	9

Food Type	Temperature settings °C		Time Approx.	Shelf Position
	Conv 	Fanned 		
Cakes				
Small cakes	190	160	15 - 25	2 - 4
Victoria sandwich	180	160	20 - 30	3
Semi rich fruit cake	150	125	2.5HRS - 3HRS	2
Christmas cake	150	125	2.5HRS - 3HRS	2
Puddings				
Bread and butter pudding	170	150	45 - 1hr	3
Fruit crumble	200	175	40 - 1hr	3
Miscellaneous				
Yorkshire pudding: large	220	200	40 - 48	4 - 5
small	220	200	15 - 20	4 - 5
Shortcrust pastry	200	180	Depends on filling	4 - 5

USING THE MAIN OVEN - ELECTRIC

Traditional fruit cakes

It should be remembered that ovens can vary over time, therefore cooking times can vary, making it difficult to be precise when baking fruit cakes.

It is necessary therefore, to test the cake before removal from the oven. Use a fine warmed skewer inserted into the centre of the cake. If the skewer comes out clean, then the cake is cooked.

- Follow the temperatures suggested in the recipe and then adjust accordingly to the conversion table.
- Do not attempt to make Christmas cakes larger than the oven can cope with, you should allow at least 25mm (1 inch) space between the oven walls and the tin.
- Always follow the temperatures recommended in the recipe.
- To protect a very rich fruit cake during cooking, tie 2 layers of brown paper around the tin.
- We recommend that the cake tin is not stood on layers of brown paper, as this can hinder effective circulation of air.
- Do not use soft tub margarine for rich fruit cakes, unless specified in the recipe.
- Always use the correct size and shape of tin for the recipe quantities.

Roast turkey

Roasting turkey involves cooking two different types of meat - the delicate light breast meat, which must not be allowed to dry out, and the darker leg meat, which takes longer to cook.

The turkey must be roasted long enough for the legs to cook, so frequent basting is necessary. The breast meat can be covered once browned.

- Always make sure that the turkey is completely thawed and that the giblets are removed before cooking.
- Turkey should be roasted at 160°C - 180°C (fanned) or 180°C - 200°C (conventional) for 20 minutes per lb, plus 20 minutes, unless packaging advises otherwise.
- The turkey can be open roasted, breast side down, for half of the cook time, and then turned over for the remainder of the cooking time.
- If the turkey is stuffed, add 5 minutes per lb to the cooking time.
- If roasting turkey covered with foil, add 5 minutes per 1lb to the cooking time.

To test if the turkey is cooked, push a fine skewer into the thickest part of the thigh. If the juices run clear, the turkey is cooked. If the juices are still pink, the turkey will need longer cooking.

USING THE MAIN OVEN - ELECTRIC

Roasting guide

The times given in the roasting guide are only approximate, because the size and age of the bird will influence cooking times as will the shape of a joint and the proportion of the bone.

Frozen meat should be thoroughly thawed before cooking. For large joints it is advisable to thaw over night.

Frozen poultry should be thoroughly thawed before cooking. The time required depends on the size of the bird - eg; a large turkey may take up to 48 hours to thaw.

Use of a trivet with a roasting tin will reduce fat splashing and will help to keep the oven interior clean. Alternatively, to help reduce fat splashing, potatoes or other vegetables can be roasted around the meat/poultry.

Notes:

- When cooking stuffed meat or poultry calculate the cooking time from the total weight of the meat plus the stuffing.
- For joints cooked in foil or covered roasters, and for lidded casseroles, add 5 minutes per 450g (1lb) to the calculated cooking time.
- Smaller joints weighing less than 1.25kg (2½lb) may require 5 minutes per 450g (1lb) extra cooking time.
- Position the oven shelf so that the meat or poultry is in the centre of the oven.
- It is recommended that the appliance is cleaned after open roasting.

Cook in main oven at: 160°C - 180°C (fanned) 180°C - 200°C (conventional)		Approximate Cooking Time (preheated oven)
Beef	Rare Medium Well done	20 minutes per 450g (1lb), plus 20 minutes 25 minutes per 450g (1lb), plus 25 minutes 30 minutes per 450g (1lb), plus 30 minutes
Lamb	Medium Well Done	25 minutes per 450g (1lb), plus 25 minutes 30 minutes per 450g (1lb), plus 30 minutes
Pork		35 minutes per 450g (1lb), plus 35 minutes
Poultry		20 minutes per 450g (1lb), plus 20 minutes

USING THE CLOCK/PROGRAMMER-ELEC(IF FITTED)

THE ALTERNATIVE PROGRAMMERS

There are two types of programmer covered in this section - push button & touch control. Both programmers have the same symbol variants & functions but may vary in their method of operation.

The push button programmer

Symbol	Symbol	What is it?
∨	-	<p>Down/minus</p> <p>Used to decrease cook / end time, remove minutes from the minute minder and adjust the time of day. Also for listening to and setting the alarm tone.</p>
∧	+	<p>Up/plus</p> <p>Used to increase cook / end time, add minutes to the minute minder and adjust the time of day.</p>
<p>FUNCTION or</p> 	<p>MODE</p>	<p>Function button</p> <p>Used to select the functions available on this timer.</p> <p>Press once for: Minute Minder. Press twice for: Cook time Press three times for: End time.</p> <p>How to use these functions is explained later on in this section.</p>

The 'function' button in the centre is used for setting the minute minder and setting up the automatic cooking. See below for details.

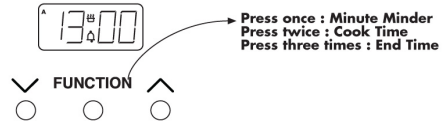

Symbols on the LED display.

This 'A' symbol appears when either a semi, or fully automatic program is selected. This symbol will flash while a program is being set.



Once a program is set the symbol will light up, and remain lit until the alarm sounds, or the program is cancelled.

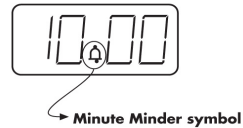

This bell symbol appears when the Minute Minder function has been selected.

While the Minute Minder is being set, the Bell symbol flashes. Once the length of time is set, the Bell symbol remains lit until the time runs down, or the function is cancelled.



This message and 'A' symbol appear when you are asked to set the length of time you require the oven to cook automatically for. Using the Up and Down buttons adjusts this accordingly.



This message and 'A' symbol appear when

USING THE CLOCK/PROGRAMMER-ELEC(IF FITTED)

you are asked to enter in an end time, or when you would like the oven to switch itself off.

To set the time of day

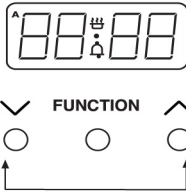

- Press the Up and Down buttons together for a few seconds, and release.
- The '•' in between the numbers on the LED Display will begin to flash.
- While the '•' is flashing it is possible to adjust the time using the Up and Down buttons. Once the time has been set, allow approximately 30 seconds before using any of the other timer functions. This ensures that the time will remain correct.

To select an alarm tone

There are three tones to choose from.

- Press and hold the down button to listen to the first tone.
- Release the down button and press it again to listen to the second tone etc.
- Releasing the down button after the tone has sounded will automatically select that tone.

Setting the minute minder

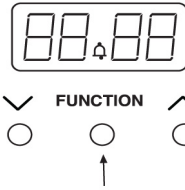

- To set the Minute Minder, press the Function button once. The bell symbol will appear and start flashing. The flashing only lasts for 5 seconds so the time must be set within this time frame.
- Use the Up and Down button to set the length of time required. Once this has been done, the Minute Minder is set.
- When the desired length of time has counted down the alarm will sound.
- To cancel the tone, press any of the buttons.
- To cancel the Minute Minder at any time, press the Up and Down buttons together.

USING THE CLOCK/PROGRAMMER-ELEC(IF FITTED)

Semi-automatic cooking

There are two types of semi automatic cooking available on this appliance.

The oven must be switched on, and in use to use either of these functions successfully.

The Duration method allows you to set the oven for a specific length of time. If a dish needed 2 hours to cook, then it would be possible for you to set the oven to turn off 2 hours later. This allows you to be sure that your food will be cooked for a set length of time and no longer.

The End Time method allows you to enter a specific time when you would like the oven to switch off. If you wish to leave the oven unattended, then it offers peace of mind that the oven will have turned itself off at the set time.

However, once the program is set then it cannot be adjusted. Extra time cannot be added, nor can the end time be extended.

To cancel the semi automatic programs, press both the Up and Down buttons together. This can be done at any time during the cooking process. Then if necessary, re program.

For the instructions on how to use both of these functions, please see the following page.

Fully automatic cooking

This function incorporates both a duration and an end time and is meant to be used when you wish to delay the start time.

We recommend that the first few times this function is used you are in the house, this will familiarise you with your oven and prevents food from being over cooked or under cooked.

Care must be taken when selecting foods for this function, it is not recommended for certain food items which may spoil, or are sensitive to being left.

It is also advisable to set the end time to be as close to your return as possible to prevent food being left standing.

USING THE CLOCK/PROGRAMMER-ELEC(IF FITTED)

SEMI-AUTOMATIC COOKING

The duration method

- Press the Function button twice,(1) which will skip past the Minute Minder.
- The LED display will flash the word 'dur', (2) and the 'A' will flash on the left hand side of the display.
- Use the Up and Down buttons to set the length of time you want to cook for.(3) This must be done within 5 seconds or the time of day will show again.

Once this is done the oven will automatically switch off once the time has elapsed, and the alarm will sound.

To switch off the alarm, press any button.
To view any remaining time press the function button twice.

The end time method

- Press the Function button three times, which will skip past the Minute Minder and the Duration programmer. (4)
- The LED display will flash the word 'End' and the 'A' will flash on the left hand side of the display. (5)
- Use the Up and Down buttons to select the time the oven is required to turn off. (6)

Once this is done the oven will turn itself off at the time you have selected.

To switch off the alarm, press any button.

1. The Duration method

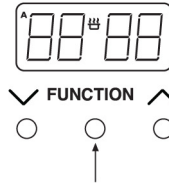

2.



3.

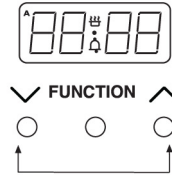

4. The End Time method

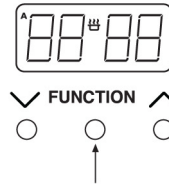

5.



6.

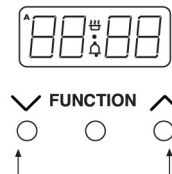

USING THE CLOCK/PROGRAMMER-ELEC(IF FITTED)

FULLY AUTOMATIC COOKING (EXAMPLE)

This programming method is best suited for when a delayed start time is required. Unlike the semi automatic methods this requires both the duration and the end time to be entered. The timer will work out the start time and begin cooking.

- Press the function button twice to select the length of time your food will need. (7)
- The 'A' on the left hand side will flash and the 'dur' message will flash up. (8)
- Using the Up and Down buttons set the time you require within 5 seconds of the 'dur' message. (9)
- Press the function button three times until the 'A' flashes again and the 'End' messages appears. (10) & (11)
- Using the Up and Down buttons, set the time you would like the oven to switch off. (12)
- Set the temperature of the oven and place the food inside.

While the automatic function is running, the 'A' will appear statically on the display, with the time.

Try to keep the end time as close to when you expect to return, this will prevent cooked food from being left standing in a warm oven.

The timer will calculate the appropriate start time.

To switch off the alarm, press any button.

7

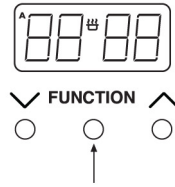

8



9

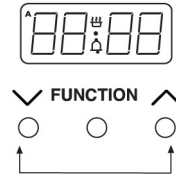

10

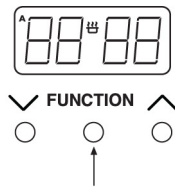

11



12

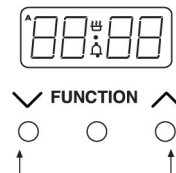

USING THE CLOCK/PROGRAMMER-ELEC(IF FITTED)

The touch control programmer

There are three touch control icons for this timer - the table below shows you what the symbols look like, depending on the model type, & their functions.

Note - some functions require you to 'touch & hold' an icon for a few seconds, whilst others require you to just 'touch' the icon without holding.

The 'function' icon in the centre is used for setting the minute minder & setting up the automatic cooking - see below for details.

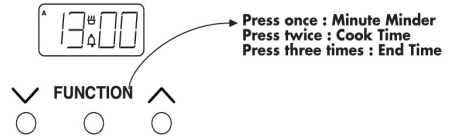

Sym- bol	Sym- bol	What is it?
∨	-	Down/minus Used to decrease cook / end time, remove minutes from the minute minder and adjust the time of day. Also for listening to and setting the alarm tone.
∧	+	Up/plus Used to increase cook / end time, add minutes to the minute minder and adjust the time of day.
FUNC- TION	MODE	Function icon Used to select the functions available on this timer. Touch once for: Minute Minder. Touch twice for: Cook time Touch three times for: End time. How to use these functions is explained later on in this section.

Symbols on the LED display.

This 'A' symbol appears when either a semi, or fully automatic program is selected. This symbol will flash while a program is being set.

Once a program is set the symbol will light up, and remain lit until the alarm sounds, or the program is cancelled.

This Bell symbol appears when the Minute Minder function has been selected.

While the Minute Minder is being set, the Bell symbol flashes. Once the length of time is set, the Bell symbol remains lit until the time runs down, or the function is cancelled.

This message and 'A' symbol appear when you are asked to set the length of time you require the oven to cook automatically for. Using the Up and Down icons adjusts this accordingly.

This message and 'A' symbol appear when you are asked to enter in an end time, or when you would like the oven to switch itself off.

USING THE CLOCK/PROGRAMMER-ELEC(IF FITTED)

Setting the time of day

Touch & hold the centre (function) icon for a few seconds until the ● symbol between the numbers on the LED display flashes.

While the ● symbol is flashing, you can adjust the time of day by touching the plus & minus icons. Please note: the hours & minutes adjust quickly.

Important - once the time of day has been set, allow approximately 30 seconds before using any of the other programmer functions. This ensures that the time of day will remain correct.

Setting an alarm tone

Touch & hold the plus & minus icons simultaneously until the ● symbol flashes & you hear a beep - then touch the centre (function) icon.

Touch the minus icon to select the tone.

You can change the tone by repeatedly touching the minus icon - there are three tones to choose from.

Setting the minute minder

To set the minute minder, touch & hold the centre (function) icon until the bell symbol appears & begins to flash. Important - the flashing will last for approximately five seconds, so any setting must be carried out within this time frame.

Touch the plus & minus icons to set the length of time required. Once this has been done, the minute minder is set.

When the desired length of time has counted down, the alarm will sound. To cancel the tone, touch & hold any of the icons.

To cancel the minute minder at any time, touch & hold the plus & minus icons together.

Semi-automatic cooking

Method 1 - duration (switch off after set time period):

Touch & hold the centre (function) icon; the bell will flash & you will hear a beep. Touch the centre (function) icon again - this will skip past the minute minder function.

The display will flash the word 'dur' & the 'A' will flash on the left hand of the display.

Use the plus & minus icons to set the length of time you want to cook for. The flashing will last for approximately five seconds, so the setting must be done within this time frame or the time of day will show again.

Once the duration has been set, the oven will automatically switch off. When the set time has elapsed the alarm will sound. To switch the alarm off, touch any icon.

To view any remaining time, touch & hold the centre (function) icon & touch again.

To cancel the semi-automatic programme at any time, touch the plus & minus icons together.

Method 2 - end time (switch off at a set end time):

Touch & hold the centre (function) icon; the bell will flash & you will hear a beep. Touch the centre (function) icon again - twice - this will skip past the minute minder & duration functions.

The display will flash the word 'End' & the 'A' will flash on the left hand of the display.

USING THE CLOCK/PROGRAMMER-ELEC(IF FITTED)

Use the plus & minus icons to select the time the oven is required to switch off.

Once this is done the oven will switch itself off at the pre-selected time. To turn the alarm off, touch any icon.

To cancel the semi-automatic programme at any time, touch the plus & minus icons together.

Fully automatic cooking

This function allows the cooker to switch on & off automatically. It requires both the duration & the end time to be entered. The timer will work out the start time & begin cooking.

Touch & hold the centre (function) icon; the bell will flash & you will hear a beep. Touch the centre (function) icon again - this will skip past the minute minder function.

The display will flash the word 'dur' & the 'A' will flash on the left hand of the display.

Use the plus & minus icons to set the length of time you want to cook for. The flashing will last for approximately five seconds, so the setting must be done within this time frame or the time of day will show again.

Touch the centre (function) icon again - this skips past the minute minder & duration functions.

The display will flash the word 'End' & the 'A' will flash on the left hand of the display.

Use the plus & minus icons to select the time the oven is required to switch off.

Set the temperature of the oven & place the food inside. The timer will calculate the start time.

When this is done the oven will turn itself off at the time you have selected. To switch off the alarm, touch any icon.

To cancel the automatic programme at any time, touch the plus & minus icons together.

USING THE MINUTE MINDER (IF FITTED)

ELECTRONIC MINUTE MINDER

Initial display

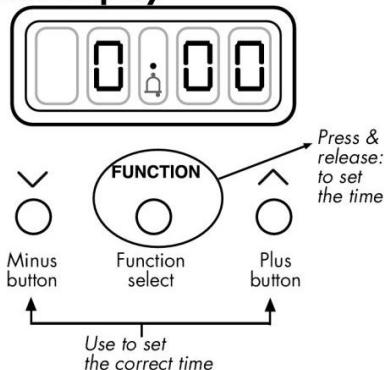

The digital timer enables you to set the time of day (24 hour clock) and the minute minder alarm.

Setting the "Time of Day"

- Switch on the electricity supply to the appliance.
- The display will flash.
- Press and release the time of day button.
- Set the time of day with the plus and minus buttons.
- The time will be set 7 seconds after the last plus or minus operation.

Alarm tones

After setting the time of day, you can select one of three alarm tones.

Press the minus button to listen to the first tone, then release the minus button and press it again to listen to the second tone, etc.

Releasing the minus button after a tone has sounded will automatically select that tone.

Setting the minute minder

- Press and release the plus button to change the display from clock to minute minder - the bell symbol will light.
- Use the plus and minus buttons to set the length of time before the alarm tone will sound. The display will increase/decrease in units of 10 seconds up to 99 minutes 50 seconds, and in units of 1 minute from 1 hour 40 minutes upwards. The maximum period which may be set is 10 hours.

The display format will change after 99 minutes and 50 seconds to 1 hour and 40 minutes.

During countdown, the minute minder has priority on the display, which will show (in minutes : seconds, or hours : minutes) the time remaining.

When countdown is complete, the tone will sound for 7 minutes, or it can be reset with one touch of any button.

To cancel the minute minder at any other time, run down the set time with the minus button.

The display will revert to show the time of day.

MECHANICAL MINUTE MINDER

Turn the minute minder control knob fully to the maximum setting, then turn back to the desired setting.

When countdown is complete, the timer will give a audible signal for a few seconds before it stops.

CLEANING

General

- It is important to clean the product regularly as a build up of fat can affect its performance or damage it and may invalidate your guarantee.
- Always switch off your appliance and allow it to cool down before you clean any part of it.
- Do not use undiluted bleaches, products containing chlorides, wire wool or abrasive cleaners on aluminium, stainless steel, or plastic/painted parts as they can damage the appliance. Nylon pads can also be unsuitable.
- Take extra care when cleaning over symbols on fascia panels. Excessive cleaning can lead to the symbols fading.

Painted & Plastic parts

- Only use a clean cloth wrung out in hot soapy water.
- Do not use abrasive cleaners, such as "Cif", wire or nylon cleaning pads on these parts.

Stainless steel & Aluminium surfaces

- Only use a clean cloth wrung out in hot soapy water, and dry with a soft cloth.
- Stubborn marks can be removed using a stainless steel cleaner. Supplies can be purchased from the Customer Care Centre.
- Sharp objects can mark the surface of stainless steel, but will become less noticeable with time.
- Wipe any spillage immediately, taking care to avoid burning your hands.

- Some foods are corrosive eg; vinegar, fruit juices and especially salt - they can mark or damage the metal if they are left on the surface.
- Baby oil can be used to restore stainless steel finishes - but only use a few drops. Don't use cooking oils as they can contain salts, which will damage the metal.
- Do not use steam cleaners.

Enamel surfaces & parts

- Clean with warm, soapy water and a clean cloth.
- If larger splashes of fat do not readily disappear, you can use a mild cream cleaner to remove them. More stubborn marks can be removed using a soap filled pad.
- Rinse well and dry with a soft clean towel or cloth.
- Do not use steam cleaners.

Glass parts

WARNING:- Do not use harsh abrasive cleaners or sharp metal scrapers to clean the oven door glass since they can scratch the surface, which may result in shattering of the glass.

- Only use a clean cloth wrung out in hot soapy water, or a specialist glass cleaner.
- Rinse away any excess cleaner and dry with a soft cloth.

Chrome plated parts

- Use a moist soap filled pad, or place in a dishwasher

CLEANING

REMOVING OVEN PARTS FOR CLEANING

Inner Door Glass

- The inner door glass panel can be removed for cleaning but it must be replaced the right way up. If there is any writing on the glass, you must be able to read it clearly when the cavity doors are open.
- Always make sure that the glass is pushed fully into the Stop position.
- To remove the glass panel, open the door wide, hold the top and bottom edges and slide out.
- Warning: do not operate the appliance without the glass panel correctly fitted.
- For your safety, glass door panels are made of toughened glass. This ensures that, in the unlikely event that a panel breaks, it does so into small fragments to minimise the risk of injury. Please take care when handling, using or cleaning all glass panels, as any damage to the surfaces or edges may result in the glass breaking without warning or apparent cause at a later date. Should any glass panel be damaged, we strongly recommend that it is replaced immediately.

Shelf Runners

- Shelf runners can be removed to enable you to clean them thoroughly. Make sure they are cool to touch and then grasp the runners and slide out of their hanging holes.

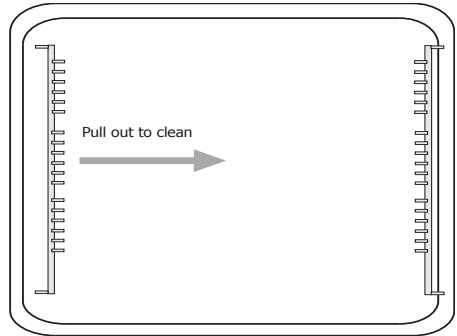

INSTALLATION INSTRUCTIONS RANGE ELECTRIC

Moving the cooker

Please note that the weight of this appliance is approximately 110kg (unpacked). Take care if the appliance needs to be lifted during installation. It is advised that multiple personnel are used when moving this appliance - always use an appropriate method of lifting.

Do not attempt to move the cooker by pulling on the doors or handles. Open the doors and grasp the frame of the cooker, taking care that the doors do not shut on your fingers.

Take care to avoid damage to soft or uneven floor coverings when moving the appliance. Some cushioned vinyl floor coverings may not be designed to withstand sliding appliances without marking or damage.

Important: Ensure that you route all mains cables well clear of any adjacent heat source.

INSTALLATION INSTRUCTIONS RANGE ELECTRIC

Clearances

This cooker must have a 10mm gap between the side of the appliance and the base and wall units of your kitchen.

- No obstructions/extractor hoods are to be placed between the top of the canopy and the ceiling once the appliance has been installed.

- Please adhere to the manufacturers instructions.

The important dimensions are those around the appliance.

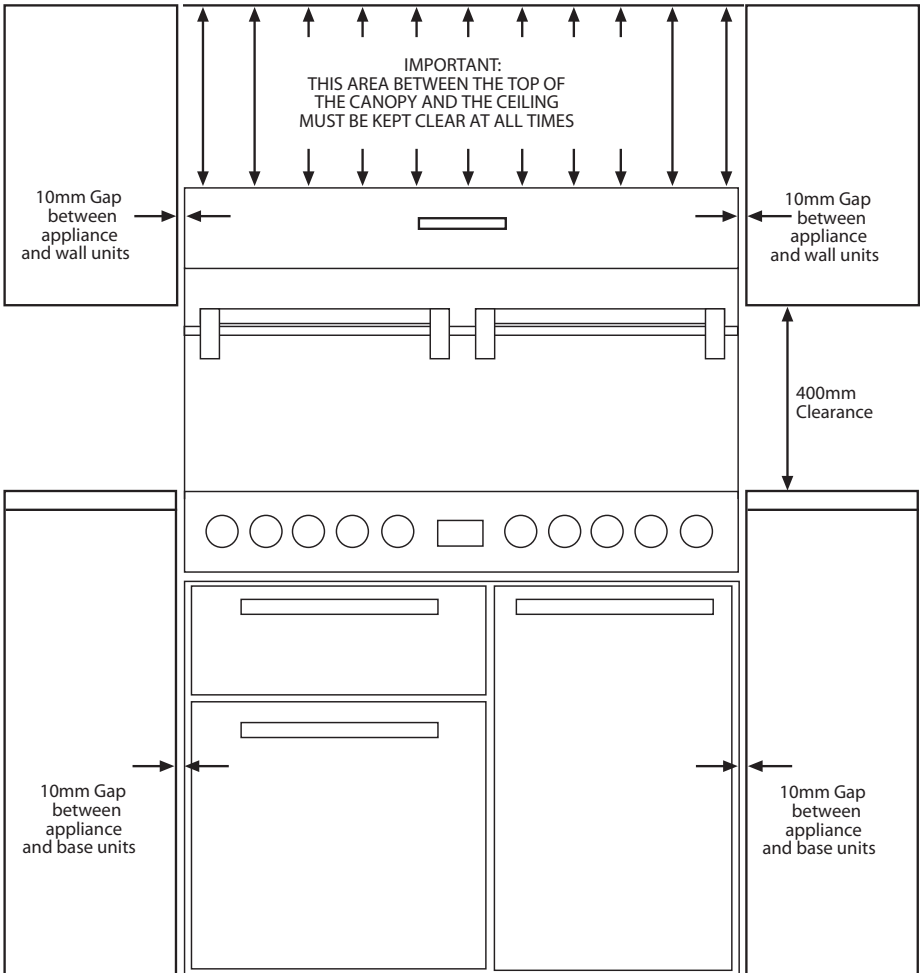

WIDTH OF APPLIANCE: 900mm
HEIGHT OF APPLIANCE: 1520-1550mm

INSTALLATION INSTRUCTIONS RANGE ELECTRIC

Fitting the plinth (if applicable)

- Ensure the appliance is raised to a height of 915mm or above using adjusting feet (A) before beginning.
- Open the appliance doors and loosen screw (C), do not remove the screw entirely. If your appliance has a storage drawer at the bottom, you access these screws through holes located at the base of the drawer after lifting the mat.
- Fit plinth (B) and secure using screw (C).

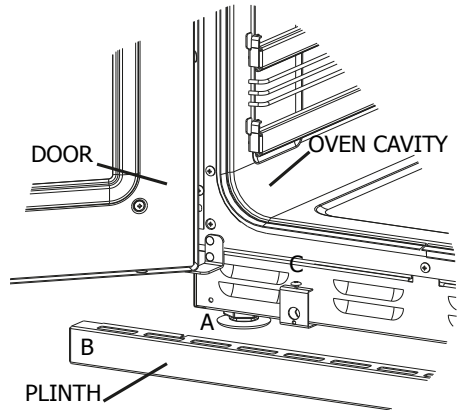

Securing the canopy (if applicable)

- Fit screw(s) A through holes 1 and into holes 2 at both ends of the rear surface of the canopy.
- Ensure that the product is level and use the holes in the bracket as a template and mark the fixing hole positions.
- Drill and plug the wall to accommodate the product. (Note: Plugs not supplied)
- Fixing to the wall should be carried out in line with sound building practices. (Note: Plugs and screws not supplied)

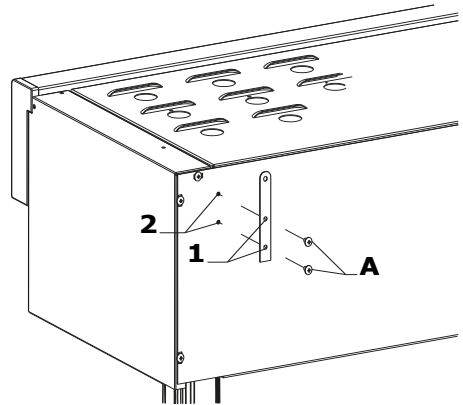

Fitting the towel rail (if applicable)

- On the towel rail there are two holes, top (A) and bottom (B), these holes have corresponding holes on the fascia at each end.
- The screw for the top hole (A), must be screwed into the supplied adaptor, whereas the remaining screw just goes through the bottom hole (B). Both screws are M6 screws. Using the allen key provided, tighten the screws making sure that the towel rail is flush to the fascia, but not over tightened.

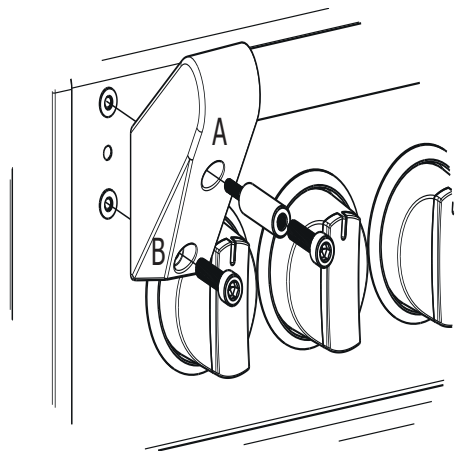

INSTALLATION INSTRUCTIONS RANGE ELECTRIC

CONNECTING THE ELECTRICITY SUPPLY - TERMINAL BLOCK

- This appliance must be fitted using a double pole unit of 45 ampere minimum capacity with 3mm minimum contact at all poles.
- Access to the mains terminal is gained by removing the terminal block cover at the rear of the appliance.
- Connection should be made with a suitable flexible cable.
- First strip the wires then push the cable through the cable clamp.
- Connect the cable to the terminal block and tighten the cable clamp screws - see diagram.
- Refit the terminal box cover.
- Sufficient cable should be used to allow the cooker to be pulled out, but must hang clear of the floor so it does not become twisted or trapped when the cooker is pushed back.

Please ensure that the user has this copy of the handbook, and the appliance is in place. Thank you.

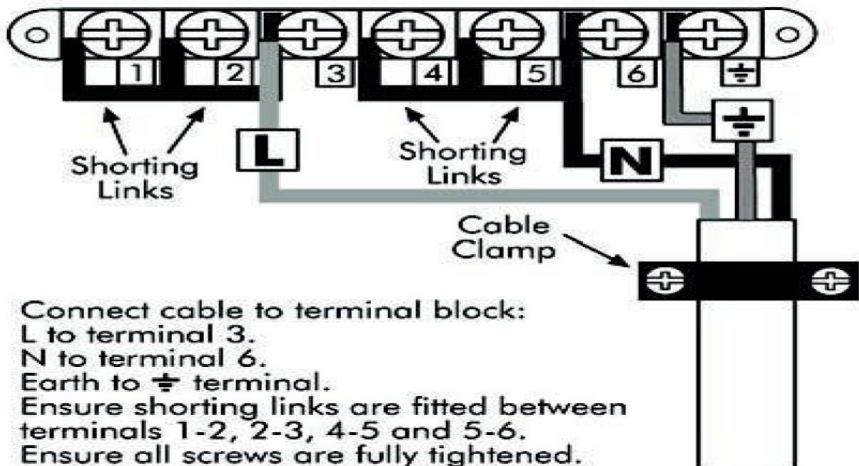

TECHNICAL DATA

Hotplate Element	kW Rating @ 240v
Ceramic	
Hob - Small	1.2kW
Hob - Large	1.8kW
Hob - Dual zone	
- single	0.7kW
- dual	2.2kW

Fuel Type	Fanned oven	Variable grills
Electric @ 240V	2.0kW (LH Oven) 2.5kW (RH Oven)	1.8kW (LH) 1.8kW (RH)
Slow cook oven	Oven lamps	
0.17kW	25W each	
Appliance size	90cm (Cookcentre)	
Max load @ 240v	16.430kW	

Countries of destination: GB; IE

CUSTOMER CARE

FAQs

What parts of the appliance can be washed in a dishwasher?

- Any enamelled parts such as the grill-pan can be cleaned in a dishwasher, as can oven shelves and shelf guides.

What parts must NOT be cleaned in a dishwasher?

- Parts such as burner skirts and caps, control knobs and any cast iron items must not be cleaned in a dishwasher, they should be cleaned with hot soapy water and a nylon brush once they are cool enough.

There's been a power failure and the product won't work.

- Switch off the electricity supply.
- When the power returns switch the electricity supply back on and re-set any programmer/clock to the correct time of day.

My oven is a single combined oven and grill - can I use both functions together?

- No. You can only use one or the other.

Why is there condensation on the doors?

- Condensation is caused by hot, moist air meeting a cooler surface (i.e. the oven door). You cannot always prevent it, but you can minimise it when it happens by doing the following:
- Pre-heat the oven at a high temperature before putting food in the oven, and cover the food you are cooking wherever possible.
- Whenever you can, cook wet foods at higher temperatures.
- Don't leave food in the oven to cool down.
- Automatic cooking will normally pro-

duce condensation when the oven is cooling down with food inside.

Should the cooling fan continue to run once the appliance has been switched off?

- Yes. This is to make sure that you can always touch the control knobs to make temperature adjustments, and turn your appliance off.

What is a Multifunction oven?

- A multifunction oven combines a variety of features, which are explained fully earlier in this book (if fitted), it allows you more flexibility when cooking.

The neon on my appliance keeps going out and coming back on again - is this right?

- Yes. In most cases the neon (if fitted) will cycle on and off to show that oven is maintaining your temperature choice.

Call Customer Care for a Service Engineer's visit if:

- You find that the oven becomes hotter at a particular temperature - the thermostat may need replacing.
- The cooling fan fails to work.

CUSTOMER CARE

CHANGING LIGHT BULBS (where fitted)

Warning: There is a risk of electric shock, so always make sure you have turned off and unplugged your appliance before starting. Always allow the product to cool down before you change a bulb.

Not all appliances have the same number and type of bulbs. Before replacing your bulb, open the oven door and see which type you have. Then use the table to help you change your bulb correctly.

Bulbs can be purchased from hardware stores (always take the old bulb with you).

Please remember that bulbs are not covered by your warranty.

No of Lamps	Bulb location	Oven Type	Instructions
2	Side	All	Remove the oven shelves. Grasp the lens cover on the light fitting and pull it away from the side of the oven. Unscrew the bulb and replace. Replace the lens cover
1	Rear	Fanned/Multifunction (Electric)	Remove the oven shelves. Remove the loose oven back by unscrewing the 4 securing screws (one at each corner) and remove. Unscrew the lens cover by turning anticlockwise. Remove the bulb and replace. Replace the lens cover and oven back.
1	Rear	Conventional/Fanned (Gas)	Remove the oven shelves. Unscrew the lens cover by turning anticlockwise. Remove the bulb and replace. Replace the lens cover.

Please keep this handbook for future reference, or for anyone else who may use the appliance.

CUSTOMER CARE

For spares and after-sales service please contact Burco on:

T: 0844 815 3745

F: 0844 815 3748

E: info@gdha.com

Please ensure that you have the product's model no and serial no available when you call. These can be found on the silver data label on your product which is located:

Ovens	Open the door; adjacent to the oven cavity
High-level grill products	Inside the base compartment
Hobs	On the underside of the product

Enter appliance numbers here for future reference:

Model No.:

--	--	--	--	--	--	--	--	--	--

Serial No.:

--	--	--	--	--	--	--	--	--	--

SERVICE RECORD

Date of purchase	Installed by	Installation Date
Place of purchase:		

Date	Part(s) replaced	Engineers' name

For customers outside the UK and Northern Ireland, please contact your local supplier.

Glen Dimplex Professional Appliances
(A Division of Glen Dimplex Home Appliances)
Stoney Lane, Prescot, Merseyside, L35 2XW
www.gdpacatering.com