

# Installation and operation manual

---

## Pass Through Warewashers

# CLASSEQ

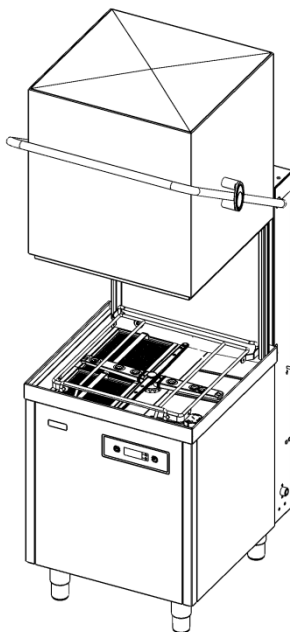

**P500**

**P500A**

**P500AS**

**P500A WS**

**P500AS WS**

A - Air break

WS – Water Softener

AS – Dual Rinse Element

**CAUTION:** Read these instructions before operating the warewasher

Dear Customer,

Thank you for choosing **Classeq**, the warewasher you have selected has been designed to give you lasting service.

Please read these instructions before installing, commissioning and operating this warewasher.

The information contained herein is provided to avoid accidental risks and/or damage to either yourself or your warewasher.

Make sure you and any other users understand the controls prior to using your warewasher.

Please keep these instructions in a safe place for future reference.







If you have any questions, or are not sure about any information contained in this manual please contact either your distributor or **Classeq**, in the 'Useful contact details' section of this manual (►17).

## TABLE OF CONTENTS

|     |   |    |
|-----|---|----|
| 1.  | EXPLANATION OF SYMBOLS USED.....            | 2  |
| 2.  | WARNING AND SAFETY INFORMATION .....        | 3  |
| 3.  | KNOW YOUR WAREWASHER.....                   | 6  |
| 4.  | PRE-INSTALLATION .....                      | 10 |
| 5.  | INSTALLATION .....                          | 13 |
| 6.  | COMMISSIONING .....                         | 15 |
| 7.  | OPERATION .....                             | 18 |
| 8.  | SERVICE AND MAINTENANCE .....               | 21 |
| 9.  | TROUBLESHOOTING.....                        | 23 |
| 10. | DECOMMISSIONING .....                       | 25 |
| 11. | APPENDIX A – WATER SOFTENER SETTINGS .....  | 26 |
| 12. | APPENDIX B – WATER HARDNESS EXPLAINED ..... | 27 |
| 13. | APPENDIX C – WATER HARDNESS MAP.....        | 28 |
| 14. | APPENDIX D – WAREWASHER SPECIFICATIONS..... | 29 |
| 15. | PARTS AND LABOUR WARRANTY .....             | 30 |
| 16. | NOTES .....                                 | 31 |
| 17. | USEFUL CONTACT DETAILS.....                 | 32 |

# 1. Explanation of symbols used

The following symbols have been used in this manual

|  |  |   |   |
|--|--|---|---|
|  <p><b>DANGER!</b></p>  | <p>Warning against potential serious or fatal injuries to persons if the described precautionary measures are not taken.</p>                   |  | <p>This symbol refers to a chapter with more detailed information</p>   |
|  <p><b>Warning!</b></p>   | <p>Warning against potential minor injuries to persons or potential material damage if the described precautionary measures are not taken.</p> | <p>1</p>  | <p>Refer to foot note at bottom of page</p>   |
|  <p><b>Caution</b></p>  | <p>Warning against defects in or destruction of the product if the described precautionary measures are not taken.</p>                         |  | <p>Recycle</p>  |
|  <p><b>CAUTION</b><br/>Heavy object.<br/>Two person lift required.</p> | <p>For safety reasons, Two persons are required for the task.</p>  |  | <p>For safety reasons your warewasher <b>MUST</b> be bonded to adjacent metalwork or earthed so that it is at the same potential (<i>i.e. voltage</i>).</p> |

## 2. Warning and safety information

### 2.1 Danger warnings

For safety reasons your warewasher **MUST** be bonded to adjacent metalwork or earthed so that it is at the same potential (i.e. voltage). 

A means for disconnection that has all poles separation of more than 3mm must be incorporated in the fixed wiring in accordance with wiring rules (▶4.4).

If the supply cord is damaged, it must be replaced by the CLASSEQ recommended, its service agent or similar qualified person in order to avoid a hazard.

All mains electrical work must be carried out in accordance with local and national regulations, and by a qualified electrician (▶5.3.1).

The warewasher **MUST** be disconnected from its power source during cleaning, servicing or replacing parts (▶8).

Ensure the base of the warewasher is never submerged or standing in water when operating the warewasher (▶8).

### 2.2 Warnings

The warewasher should only be operated at or within the voltage specified on the rating plate (▶4.4).

Old existing, defective or damaged water supply hoses are NOT to be used when installing your warewasher. Use CLASSEQ supplied hose. (▶4.5.1).

The installer and user are responsible for ensuring the installation and operation of this warewasher are in accordance with this manual and local and national regulation (▶5).

**DO NOT** use electrical extension lead(s) to supply power to your warewasher (▶5.3.1).

**DO NOT** run the warewasher if there is no salt in the salt reservoir, as this will allow lime scale to build up, also any lime scale will invalidate your warranty (▶6.5) (▶8.4.1).

**DO NOT** add any chemicals, such as detergent or rinse aid to the reservoir. These will cause damage to the warewasher (▶6.5)

(▶ 8.4.1).

Children should be supervised to ensure that they do not play with, or operate the warewasher (▶ 7).

Be aware: Wares may be hot when removed from warewasher (▶ 7.8).

Before cleaning the wash chamber, ensure all sharp items, such as broken glass or other items which could cause injury are removed carefully (▶ 8.1).

**DO NOT** use cleaning agents that contain CHLORINE, BLEACH or HYPOCHLORITE (▶ 8.1).

Wear protective clothing, protective gloves and protective goggles when handling chemicals and observe all safety notes and dosing recommendations printed on their packaging (▶ 5.6) (▶ 8.5).

If the warewasher is being drained immediately after use, water draining from the 'Boiler drainage hose' may reach over **95°C** (▶ 10).

If CLASSEQ's warewashers are used outside the designation for the appliance you invalidate your warranty and make the appliance unsafe.

Maximum inlet water pressure is 400 kPa and minimum inlet water pressure is 200 kPa.

For water inlet pressure >400 kPa – Pressure reducing valve required.

The warewashers are intended for fixed installation only using Classeq tabling fixed with fasteners to the floor surface and sealed to the unit. (▶ 5.67)

Any other installations must be agreed with and approved by Classeq.

### 2.3 Cautions

Only use commercial grade detergents and rinse-aids within your warewasher (▶ 5.6).

This warewasher is function for washing dishes, plates, glassware, cutlery and similar articles only. No other activity is

permitted on this warewasher (▶7).

For safety reasons, minimum two persons are required for the task (▶4.1).

**Only use granulated salt** (*max. grain size 5 – 7 mm*). Salt tablets are not suitable (▶6.5) (▶8.4.1).

If the reservoir cap is not properly secured, water and/or chemicals can leak in or out of the unit causing damage to the warewasher (▶6.5) (▶8.4.1).

Always remove excess food/debris from any dishes/glasses to be washed. **DO NOT** use your warewasher as a waste disposal unit (▶7.8).

It is very important the warewasher is drained down at the end of each working day (▶7.9).

**DO NOT** use STEEL WOOL, WIRE BRUSHES or any other abrasive materials (▶8.1).

Damage to the warewasher caused by lime scale, or poor water quality will **NOT** be covered by the **Manufacturer's Warranty** (▶8.3).

De-scale must not remain in the warewasher for more than 2 hours (▶8.5).

**DO NOT** spray the exterior or interior of the warewasher and the surrounding area (panels, base) using a water jet, steam cleaner or high-pressure cleaner (▶8).

Only authorized spare parts have to be used in the event of a breakdown (▶9).

## **General**

P500 – Pressurized warewasher

P500 A – Air break warewasher

P500 A WS – Air break and inbuilt water softener warewasher

P500 AS – Air break and 2 rinse element warewasher

P500 AS WS – Air break, 2 rinse element and inbuilt water softener warewasher

Operating noise level (All model) <70dB(A)

### 3. Know your Warewasher

Before installing your warewasher you should familiarise yourself with the various components shown below. For detailed specification see Appendix D (► 14). This warewasher is electrically operated dishwashing machines for washing plates, dishes, glassware, cutlery and similar articles, not intended for household use. This appliance is used for example in restaurants, canteens, hospitals, schools, colleges, offices, other commercial enterprises, etc.

#### 3.1 Warewasher layout

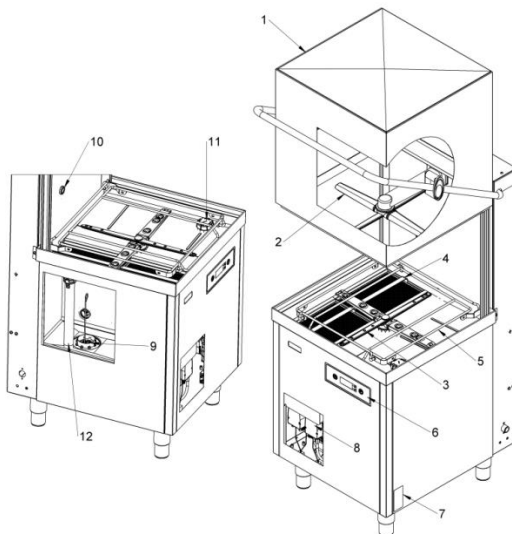

| Item | Description                     |
|------|---------------------------------|
| 1    | Hood                            |
| 2    | Top wash and rinse arms         |
| 3    | Bottom wash and rinse arms      |
| 4    | Primary Filters                 |
| 5    | Basket Ramp                     |
| 6    | User interface                  |
| 7    | Rating label                    |
| 8    | Chemical pumps                  |
| 9    | Secondary filter <sup>3</sup>   |
| 10   | Anti-syphon device <sup>3</sup> |
| 11   | Salt reservoir cap <sup>4</sup> |
| 12   | Drain plug <sup>2</sup>         |

<sup>1</sup> Images are for reference only, actual parts may differ

<sup>2</sup> Only on gravity drain ware washers

<sup>3</sup> Only on drain pump fitted ware washers

<sup>4</sup> Only on Internal Water softener fitted ware washer

### 3.2 User interface

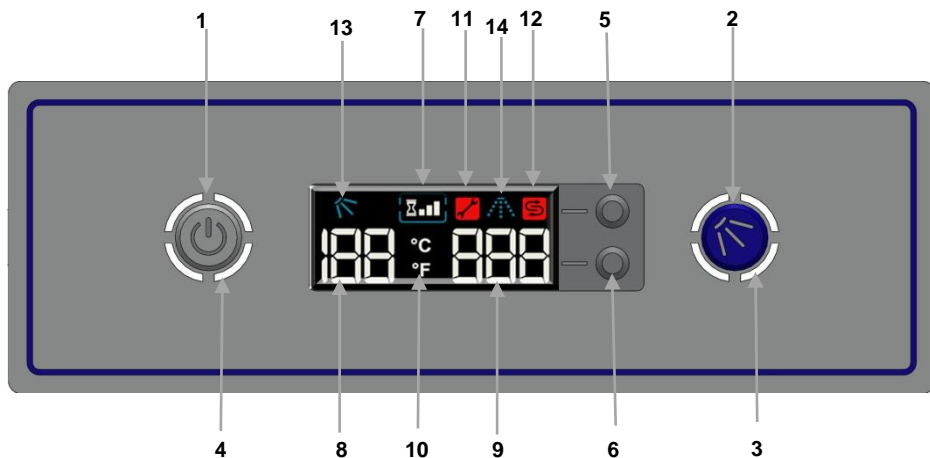

| Item | Description                        |
|------|------------------------------------|
| 1    | On/Off button                      |
| 2    | Cycle button                       |
| 3    | Cycle indicator                    |
| 4    | Heating indicator                  |
| 5    | Program select                     |
| 6    | Temperature unit button            |
| 7    | Program indication                 |
| 8    | Wash temperature                   |
| 9    | Rinse temperature                  |
| 10   | Temperature unit display           |
| 11   | Error indicator                    |
| 12   | Refill salt indicator <sup>4</sup> |
| 13   | Wash water symbol                  |
| 14   | Rinse water symbol                 |

<sup>1</sup> Images are for reference only, actual parts may differ

<sup>2</sup> Only on gravity drain ware washers







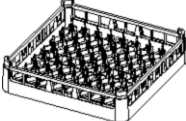
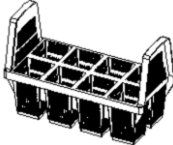

<sup>3</sup> Only on drain pump fitted ware washers

<sup>4</sup> Only on Internal Water softener fitted ware washer

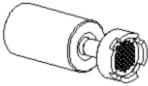

### 3.3 Accessories with your warewasher

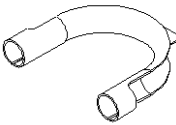
Items included within warewasher<sup>1</sup>

|  |                                       |  |  |
|--|---------------------------------------|--|--|
|  | 1 x Installation and operation manual |  | 1 x Good practice guide                |
|   | 1 x Open basket                       |   | 1 x Plate basket                       |
|   | 1 x Cutlery basket                    |   | 2 x Primary filters <sup>1</sup>       |
|   | 1 x Secondary filter <sup>3</sup>     |   | 1 x Drain plug <sup>2</sup>            |
|   | 2 x Bottle weights                    |   | 1 x Water inlet hose                   |
|  | 1 x Waste hose hook                   |  | 1 x Water softener funnel <sup>4</sup> |
| Image not shown  | 2kg Bag of salt <sup>4</sup><br>x1    |  |  |

<sup>1</sup> Images are for reference only, actual parts may differ

<sup>2</sup> Only on gravity drain ware washers

<sup>3</sup> Only on drain pump fitted ware washers

<sup>4</sup> Only on Internal Water softener fitted ware washer

### 3.4 Warewasher Specification

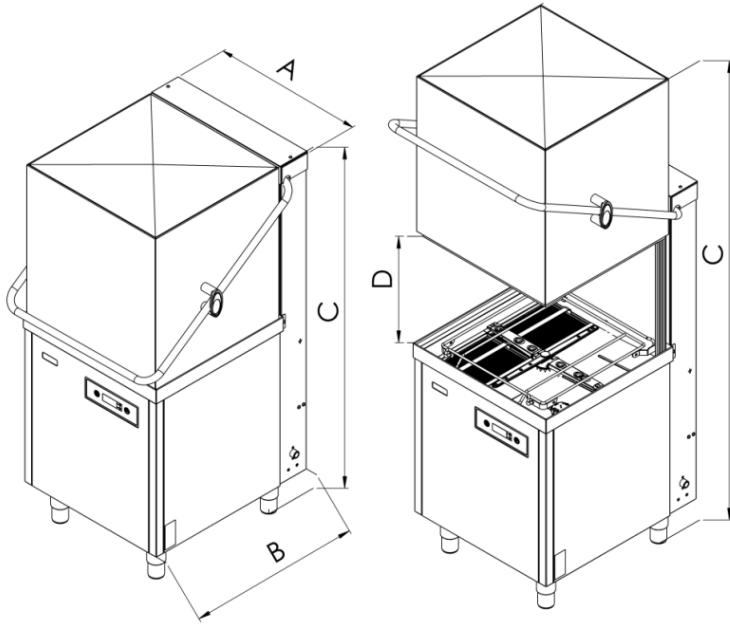

| Warewasher                          |          | P500        | P500A | P500A WS | P500AS   | P500AS WS   |
|-------------------------------------|----------|-------------|-------|----------|--|-------------|
| Dimension (mm)                      | A=Width  | Inc. Handle |       |          |  | 735         |
|                                     |          | Ex. Handle  |       |          |  | 630         |
|                                     | B=Depth  | Inc. Handle |       |          |  | 950         |
|                                     |          | Ex. Handle  |       |          |  | 735         |
|                                     | C=Height | Hood Closed |       |          |  | 1470 - 1520 |
| Hood Open                           |          |             |       |          | 1890 - 1970  |             |
| D=Entry Height                      |          |             |       |          | 440  |             |
| Basket Size (mm) (Square Basket)    |          |             |       |          | 500  |             |
| Load Capacity Max. (theoretical)    |          |             |       |          | 40 @ Short Cycle   |             |
| Load Capacity Min. (theoretical)    |          |             |       |          | 12 @ Intensive Cycle   |             |
| Load Capacity Std. (theoretical)    |          |             |       |          | 20 @ Standard Cycle  |             |
| Cycle time 'min'                    |          |             |       |          | 1.5 ( Short cycle), 3 (Standard cycle) & 5 (Intensive cycle) |             |
| Operating noise level               |          |             |       |          | <70 dB(A)  |             |
| Boiler Tank water temperature °C    |          |             |       |          | 82°  |             |
| Wash Tank water temperature °C      |          |             |       |          | 55°  |             |
| Drain Size Ø mm                     |          |             |       |          | Ø40  |             |
| Warewasher fully loaded Weight (kg) |          | 100         | 105   | 115      | 120  | 125         |

## 4. Pre-installation

After unpacking your warewasher, check it for any possible transport damage. Never install and use a damaged warewasher. If your warewasher is damaged contact your retailer immediately.

Make sure the water and electricity connections of your warewasher are in compliance with these instructions.

Remove all outer packaging and the protective film from your warewasher before positioning it.

Ensure all packaging materials are disposed of in accordance with local and national regulations.

### 4.1 Feet installation

It is very important that two person required in order to install the feet to the warewasher.



#### CAUTION!

For safety reasons, minimum two persons are required for the task.

- 1) Segregate 4 feet and 4x M6x20mm fasteners per foot.
- 2) Using 10mm Spanner tighten fasteners through feet and on to the warewasher.

Please note: Person 1 supports the tilted warewasher and person 2 installs the feet.

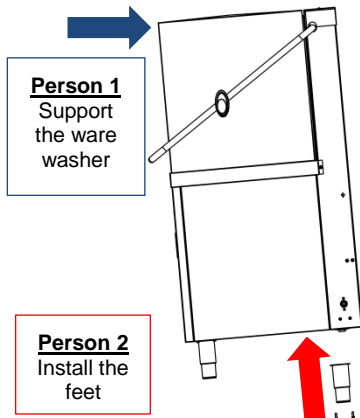
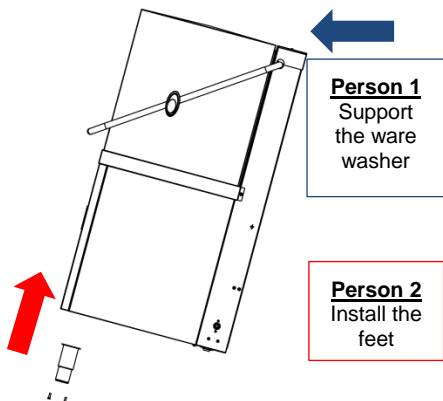

### 4.2 Re-route Drain hose

Once feet installed then locate Drain hose and re-route through drain grommet located on the base of the warewasher.

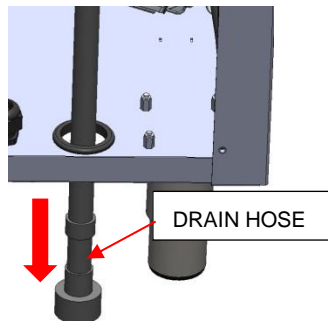
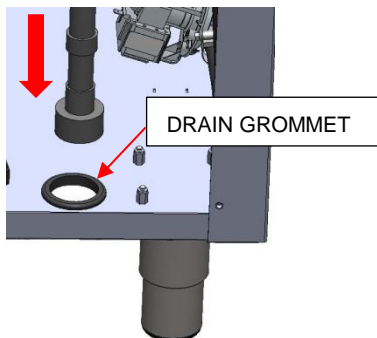

### 4.3 Equipotential bonding



**DANGER!**

For safety reasons your warewasher **MUST** be bonded to adjacent metalwork or earthed so that it is at the same potential (*i.e.* voltage).

Consult your distributor, **Classeq** or a qualified electrician if you are unsure how to do this.

### 4.4 Electrical connection

Prior to connecting the warewasher, ensure that the voltage and the supply fuse comply with the rating of the warewasher.

A means for disconnection that has an all pole separation of more than 3mm must be incorporated in the fixed wiring in accordance with wiring rules.

#### 4.4.1 Electrical cable specification

If the mains electrical supply cable is damaged or has deteriorated, it **MUST** be replaced by a cable or cord assembly supplied by **Classeq**, its service agents or similarly qualified persons in order to avoid hazards, and be to the following minimum specifications.

| Warewasher rating<br>(Volts / Phase / Amps) |                 | Cable size  |
|---|-----------------|-------------|
| 220-240V / 1N~/30A                          |                 | 3G 4.0      |
| 380-415V / 3N~/12A                          |                 | 5G 2.5      |
| 380-415V / 3N~/16A                          |                 | 5G 2.5      |
| 380-415V / 3N~/22A                          |                 | 5G 4.0      |
| Temp. rating                                | Length of cable | Conforms to |
| 60°C min.                                   | 3m              | H07RN-f     |

For electrical rating of your warewasher

refer to the rating label (▶3.1).

### 4.4.2 Electrical connection specification

Depending on the specification of your warewasher it may be supplied with or without a moulded mains electrical plug.

### 4.5 Water connections

Commercial warewasher wash results may be affected by external conditions such as incoming water temperature, pressure, hardness and choice of chemicals.

#### 4.5.1 Water supply hose

**Classeq** recommend installing a shut off valve in the mains water supply line near the warewasher such that it is easily accessible

Your warewasher is supplied with a new WRAS approved water hose (▶3.3), requiring a G $\frac{3}{4}$ " ( $\frac{3}{4}$ " BSP) male threaded connection at the mains water outlet.



**Warning**

Old existing, defective or damaged water supply hoses are **NOT** to be used when installing your warewasher.<sup>1</sup> Use CLASSEQ supplied hose.

#### 4.5.2 Water supply restrictions

##### Incoming water temperature:

- 4°C minimum
- 55°C maximum

##### Supply water dynamic pressure:

- 0 to 2 bar (0 to 200 kPa)  
(External rinse booster pump required)
- 2 to 4 bar (200 to 400 kPa)  
(No modifications required)
- >4 bar (400 kPa)  
(Pressure reducing valve required)

##### Minimum supply flow rate:

- Without internal water softener:  
11 litres/minute
- With internal water softener:  
4 litres/minute

### Water hardness:

For the longevity of your warewasher, and to ensure you get consistently good results, it is essential your warewasher either has an internal water softener unit, is fed from a soft water supply ( $\leq 3^{\circ}\text{dH}$ ) or is connected to an appropriate water softener. Appendix C has a map that can be used as a guide to water hardness in the UK (► 13).

**IMPORTANT - All supplier warranties are void if lime scale is present within your warewasher.**

#### 4.5.3 Waste water connection

The waste system of your warewasher will vary depending on the variant. You can identify the type of drain your warewasher has by checking whether there is a drain plug present. (► 3.1). Warewashers with a drain plug are gravity drain and without are pumped drain.

#### Gravity drain warewashers:

If your warewasher has a drain plug (► 3.3), fitted in the wash sump the waste hose will fit into  $\text{\O}40\text{mm}$  plumbing **or** over a  $\text{\O}20\text{mm}$  spigot.

The hose for this warewasher has to lead away below the base of the warewasher.

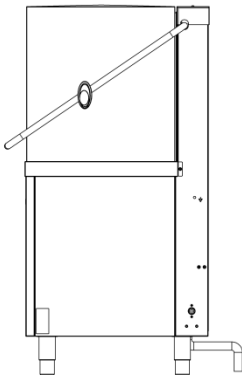

can be up to a maximum of the following height from the base of the warewasher is 700mm.

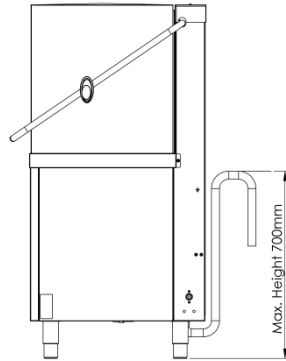

- **Pumped drain warewashers:**

The waste hose of your warewasher will fit into  $\text{\O}40\text{mm}$  plumbing **or** over a  $\text{\O}28\text{mm}$  spigot.

The waste plumbing for the warewasher

## 5. Installation



### Warning

The installer and user are responsible for ensuring the installation and operation of this warewasher are in accordance with this manual and with local and national regulations.

### 5.1 Recommended hand tools

**Classeq** recommends that the following hand tools are used to assist in installing your warewasher:

- Spirit level
- 10mm spanner/ Socket
- Multimeter or voltmeter
- Insulated Electric screw driver
- Drill with 8mm & 10mm bit

### 5.2 Warewasher placement

Your warewasher should be installed on the stable surface that is capable of holding the full weight of the warewasher (►3.4) and withstand the vibration of regular use.

Ensure there is a minimum of 20mm clearance each side and rear of the warewasher and no obstruction at the top (►3.4).

Once installed use the adjustable feet to ensure your warewasher is stable, with its weight being distributed equally and does not tilt more than 3° in any direction.

Your warewasher should be placed in a location that allows the required supplies to be fitted (►14).

When positioning the warewasher, ensure that the water inlet, chemical tubes and drain hoses are not kinked or squashed. Care must also be taken to ensure your warewasher does not rest upon any of its supply hoses/leads.

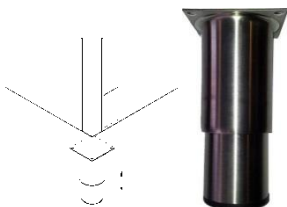

## 5.3 Electrical connection

### 5.3.1 Mains cable connection

Your warewasher must be connected directly to the mains electricity using the mains electrical cable provided. DO NOT use electrical extension lead(s) to supply power to your warewasher.

Prior to connecting your warewasher, ensure the electrical supply has a suitable and adequate circuit breaker/fuse. For the electrical rating of your warewasher refer to the rating plate (►3.1). Contact your distributor, qualified electrician or **Classeq** if you are unsure how to check this.

If the supply cord is damaged, it must replace by the CLASSEQ recommended, its service agent or similar qualified person in order to avoid a hazard.



### DANGER!

All mains electrical work must be carried out in accordance with local and national regulations, and by a qualified electrician

When hard wiring the warewasher into the socket use the multimeter or voltmeter to ensure that the connection point does not have any voltage before attempting to connect the terminals.



### 5.3.2 Equipotential bonding

Your warewasher **MUST** be earth bonded to adjacent metalwork or earthed so that it is at the same potential (*i.e. voltage*).

The equipotential bonding stud is located at the rear of the warewasher (►14) and has a M5 nut fitted. Use the spanner to connect the earth wire to this location and ensure the nut is securely fastened.

### 5.4 Water supply hose connection

Connect the 90° bend end of the water supply hose to your warewasher (►14) and the straight end to your water mains supply.



Ensure the rubber seals within the ends of the hose are in place.

Ensure all connections are water tight before using your warewasher.

### 5.5 Waste water connection

Fit the waste hose of your warewasher to the site plumbing without kinking it.

Ensure that your hose is fitted to the plumbing in a way that it will not come off or out during the operation of the warewasher.

The waste plumbing must only be connected into the foul drains and not the surface water drainage system.

A form of back flow prevention must be installed into the waste plumbing in accordance with local and national regulations.

Ensure that the waste hose of the warewasher does not pass the height of the sticker on the rear of the warewasher when the warewasher is in place.

Where the warewasher is fitted to a stand pipe the waste hose hook (▶ 3.3) should be used to help manage the hose

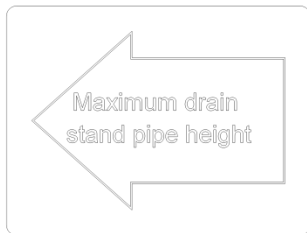

### 5.6 Fitting chemical bottles



**Warning**

Wear protective clothing, protective gloves and protective goggles when handling chemicals and observe all safety notes and dosing recommendations printed on their packaging



**Caution**

Only use commercial grade detergents and rinse-aids within your warewasher.

The chemical bottles should be placed in a safe, stable location that is close to the warewasher and easily accessed to check chemical levels and replace the bottles as needed.

A coil of PVC tube is connected to each of the chemical pumps inside the warewasher.

These tubes exit the rear of the warewasher and should be routed to the chemical bottle locations, excess tube may be removed. The tubes need to be long enough to allow the bottles to be moved without the risk of falling over.

|            |           |
|------------|-----------|
| Blue tube  | Rinse aid |
| Clear tube | Detergent |

Remove the cap from each of the chemical bottles and use the drill to make a hole in middle.

Feed the tube through the hole and fit the bottle weights and filters supplied the end of each tube before dropping them into the chemical bottles and fastening the caps.

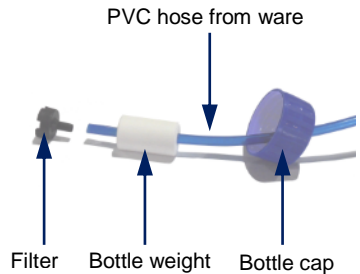

### 5.7 Tabling

The warewashers are intended for fixed installation only using CLASSEQ tabling fixed to the floor surface and sealed to the unit. Any other installations must be agreed with and approved by CLASSEQ. Fit using two fasteners per foot to the floor.

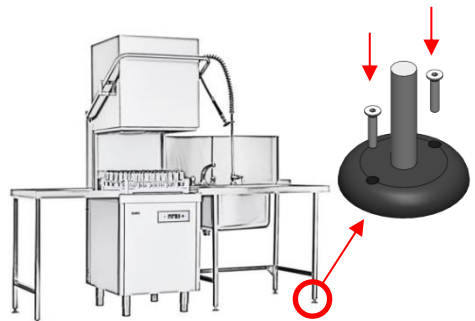

## 6. Commissioning

### 6.1 Commissioning interface

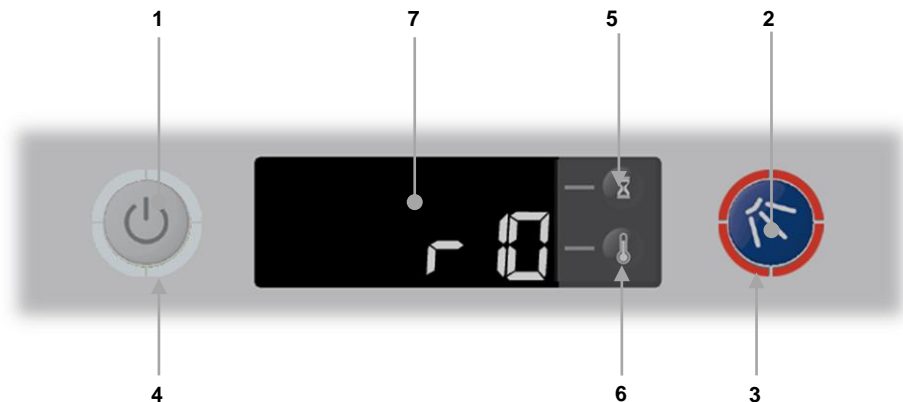

| Item | Description       |
|------|-------------------|
| 1    | Exit button       |
| 2    | Enter button      |
| 3    | Cycle indicator   |
| 4    | Heating indicator |
| 5    | Up button         |
| 6    | Down button       |
| 7    | Display           |

### 6.2 Commissioning mode

With the warewasher turned on at the mains electrical supply but off at the display, press and hold the Exit (1) and Enter (2) buttons for 3sec. the display (7) will show the first menu item and the cycle indicator (3) will illuminate red.

If no buttons have been pressed for a period of time the warewasher will cancel this mode and return to the off state.

Below is the complete menu list:

| Display | Description                           |
|---------|---------------------------------------|
| r**     | Rinse aid setting (e.g. 15 = 1.5ml/L) |
| rP□     | Rinse aid prime                       |
| d**     | Detergent setting (e.g. 33 = 3.3ml/L) |
| dP□     | Detergent prime                       |
| h**     | Water softener setting (if fitted)    |

\*\* Refers to the setting of the chemical dosing and water hardness. For example the default setting for rinse aid is 0.3ml of chemical per litre of water this will be displayed as 'r□□' the default setting for detergent is 3ml of chemical per litre of water this will be displayed as 'd3□'



### 6.3 Setting chemical dosage

Your warewasher will be set to a default chemical dosing setting however since there are many different chemicals on the market and these each have different concentration requirements the dosage can be adjusted by following the instructions below.

1. Refer to your chemical bottle or contact the supplier to find the concentration requirements for your rinse aid and detergent in millilitres of chemical per litre of water (ml/L).
2. Enter commissioning mode (▶6.2).
3. Using the up and down keys (**5 & 6**), scroll to the rinse aid setting menu item (r\*\*) and press enter (**2**).
4. The display will flash.
5. Use the up and down keys (**5 & 6**) to scroll to the required setting and press enter (**2**).
6. Using the up and down keys (**5 & 6**), scroll to the detergent setting menu item (d\*\*) and press enter (**D**).
7. The display will flash.
8. Use the up and down keys (**5 & 6**) to scroll to the required setting and press enter (**2**).
9. Press exit (**1**) until you are out of commissioning mode.

### 6.4 Priming chemicals

Before the warewasher can be used the chemical tubes will need to be filled with chemicals, in order to do this you will need to follow the below instructions to prime the chemical pumps.

1. Enter commissioning mode (▶6.2).
2. Using the up and down keys (**5 & 6**), scroll to the rinse aid prime menu item (rP) and press enter (**2**).
3. The display will flash and will change to rP l.
4. This will continually run the rinse aid pump for a maximum of 12 minutes and draw chemicals into the warewasher. When the chemicals have reached the back of the warewasher press enter (**2**).

again to stop the pump.

5. The display will stop flashing and return to rP l.
6. Using the up and down keys (**5 & 6**), scroll to the detergent prime menu item (dP) and press enter (**2**).
7. The display will flash and will change to dP l.
8. This will continually run the detergent pump for a maximum of 2 minutes and draw chemicals into the warewasher. When the chemicals have reached the back of the warewasher press enter (**2**) again to stop the pump.
9. The display will stop flashing and return to dP l.
10. Press exit (**1**) until you are out of commissioning mode.

## 6.5 Integral water softener (if fitted)

### 6.5.1 Commissioning the water softener unit

To commission the water softener unit follow the instructions below:

1. Lift the hood up.
2. Remove the basket ramp.
3. Open the salt reservoir cap at the Front right hand corner of the wash tank.
4. Fill the reservoir with fresh water.
5. Using the salt funnel supplied fill the reservoir with approximately 1.5kg of granulated salt.
6. Wipe away any excess or spilt salt from the cabinet and the reservoir opening.
7. Refit the cap to the reservoir, ensure that the cap is fitted flat and secure.
8. Make sure, that all salt residual are cleaned away or start directly after fill the salt in the water softener a wash cycle.

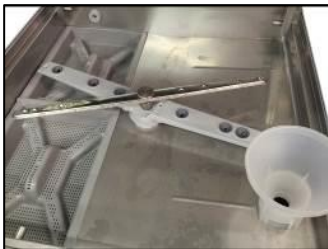

**Warning**

**DO NOT** run the warewasher if there is no salt in the salt reservoir, as this will allow lime scale to build up, also any lime scale will invalidate your warranty

**DO NOT** add any chemicals, such as detergent or rinse aid to the reservoir. These will cause damage to the warewasher.



**Caution**

**Only use granulated salt** (*max. grain size 5 – 7 mm*). Salt tablets are not suitable.

If the reservoir cap is not properly secured, water and/or chemicals can leak in or out of the unit causing damage to the warewasher.

### 6.5.2 Setting the water softener

Check the water hardness of your water supply (°d). Once you have this data follow the steps below.

1. Refer to Appendix A to find the setting required for your water hardness (►11).
2. Enter commissioning mode (►6.2)
3. Using the up and down keys (5 & 6), scroll to the water hardness menu item (h\*\*) and press enter (2).
4. The display will flash.
5. Use the up and down keys (5 & 6) to scroll to the setting you require and press enter (2).
6. Press exit (1) until you are out of commissioning mode.

### 6.6 Wash and rinse tank temperatures

The wash and rinse boiler temperatures have been pre-set to temperatures that comply with environmental health standards. For more option on settings please refer 'Engineers manual' for your warewasher.

## 7. Operation

Children should be supervised to ensure that they do not play with, or operate the warewasher.



**Caution**

This warewasher is function for washing dishes, plates, glassware, cutlery and similar articles only. No other activity permitted on this warewasher

Before operating the warewasher, ensure that the mains electrical and water supplies are turned on.

### 7.1 Operation interface

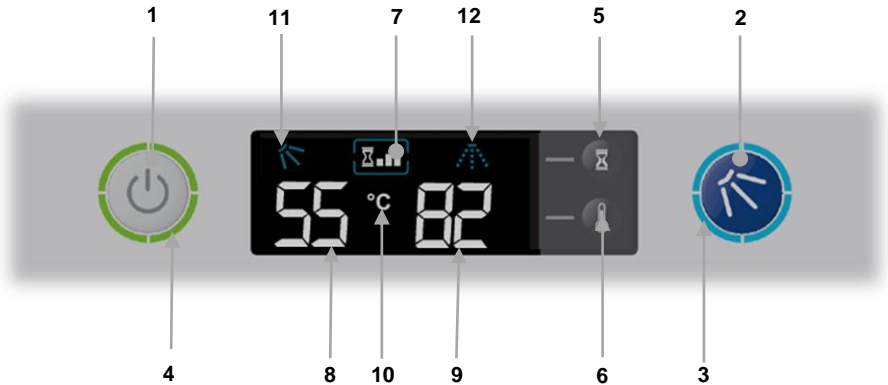

| Item | Description               |
|------|---------------------------|
| 1    | On/Off button             |
| 2    | Cycle button              |
| 3    | Cycle indicator           |
| 4    | Heating indicator         |
| 5    | Program select            |
| 6    | Temperature units button  |
| 7    | Program indication        |
| 8    | Wash temperature          |
| 9    | Rinse temperature         |
| 10   | Temperature units display |
| 11   | Wash water symbol         |
| 12   | Rinse water symbol        |

### 7.2 Turning on the warewasher

To turn on the warewasher ensure the hood is closed and press the On/Off button (1) on the keypad of the warewasher, the

display will illuminate, the warewasher will start to fill automatically as long as the hood is closed.

### 7.3 Warewasher ready to operate

Your warewasher operates a pulse fill function, this means that it will fill the rinse boiler, heat this to a pre-set temperature then transfer this water to the wash tank. During the fill stage the heating indicator (4) will flash amber.

Once the wash tank is filled and both tanks are up to the required temperatures the heating indicator will illuminate green to indicate the warewasher is ready to run a cycle.

The time required for the warewasher to fill and heat will vary depending on the power rating of the warewasher as stated on the rating label (►3.1) and the incoming water temperature, below is a guide to these times when the incoming water is 16°C.

#### 7.4

| Rating               | Time  |
|----------------------|-------|
| 220-240V / 1N~ / 30A | 45min |
| 380-415V / 3N~ / 12A | 45min |
| 380-415V / 3N~ / 16A | 35min |
| 380-415V / 3N~ / 22A | 25min |

### 7.5 Changing temperature units



The temperature displays (8 and 9) on your warewasher can be shown in °C or °F (10). Press the temperature unit button (6) to cycle between these options.

### 7.6 Selecting a wash program

Your warewasher has multiple program times; these are pre-set to offer the best possible results. To change the program press the program select button (5) until the program display (7) shows the selection you require.

When the warewasher is turned on (►7.2) it will always start on default program which is a Normal program.

### 7.6.1 Wash program options:

| Display   | Description | Time (min) |
|---|-------------|------------|
|  | Light       | 1.5        |
|  | Normal      | 3          |
|  | Intense     | 5          |

### 7.7 Loading a basket

#### For dishwashers ONLY

Long cutlery, such as ladles and long knives etc., must be placed horizontally on the open basket this will avoid possible collision with wash/rinse arms.

### 7.8 Starting a cycle

Always remove excess food/debris from any dishes/glasses to be washed. **DO NOT** use your warewasher as a waste disposal unit.

To start a cycle, follow the instructions below.

1. Lift the hood up.
2. Load the full basket, ensuring that bottom and top arms rotate freely.
3. Lift the hood down to start the cycle.
4. Alternatively, press the cycle button (2) with hood in closed position. The cycle will start once the warewasher has achieved its correct water levels and temperatures. During the cycle the blue cycle indicator (3) will be illuminated blue.

Do NOT lift the hood open during a cycle.

If the cycle button is pressed before the warewasher has reached the required levels the cycle indicator (3) will illuminate blue to indicate that a cycle has been selected, the heating indicator (4) will flash amber and the warewasher will automatically start when the requirements have been met.

5. At the end of the cycle, once the cycle indicator (3) has gone out. Lift the hood up and remove the basket
6. Reload the warewasher and repeat as required.

Wares in the basket may be wet and will dry in a short time due to evaporation.

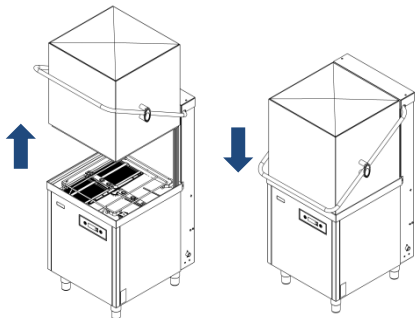

5. The warewasher will drain down the wash tank.
6. The warewasher will do a self-rinse.
7. When the cycle indicator (3) goes out the drain cycle is complete.

**Note!**

Once empty **Classeq** recommends the mains water and electricity supplies are turned off and the warewasher is cleaned (►8.2).

For hygiene reasons it is recommended that once the warewasher has been drained and cleaned the door is left open to assist in natural drying of the wash chamber.

**Note!**

Refer 'Engineers Manual' of your warewasher for more information on Settings of the warewasher.



**Warning**

Be aware: Wares may be hot when removed from warewasher

**7.9 Draining down the warewasher**



**Caution**

It is very important the warewasher is drained down at the end of each working day.

During normal operation the warewasher will drain out any excess water.

To fully drain down the warewasher follow the below instructions

**7.9.1 For gravity drain warewashers:**

1. Lift the hood up of the warewasher.
2. Locate and remove the drain plug (►3.1).

**7.9.2 For pump drain warewashers:**

1. Press the On/Off button (1) to turn off the warewasher.
2. Lift hood up and lift hood down to start the drain cycle.
3. Alternatively, press the cycle button (2) in hood closed position.
4. The cycle indicator (3) will flash blue.

## 8. Service and maintenance



**DANGER!**

The warewasher **MUST** be disconnected from its power source during cleaning, servicing or replacing parts.

Ensure the base of the warewasher is **never** submerged or standing in water when operating the warewasher.



**Caution**

**DO NOT** spray the exterior or interior of the warewasher and the surrounding area (*panels, base*) using a water hose, steam-jet air ejector or high-pressure cleaner.

### 8.1 Prior to cleaning

Ensure the warewasher has first been drained down (►7.9).

Turn off the mains electrical supply before cleaning the warewasher.



**Warning**

**DO NOT** use cleaning agents that contain **CHLORINE, BLEACH** or **HYPOCHLORITE**.

Before cleaning the wash chamber, ensure all sharp items, such as broken glass or other items which could cause injury are removed carefully.



**Caution**

**DO NOT** use **STEEL WOOL, WIRE BRUSHES** or any other abrasive materials.

### 8.2 Daily cleaning

It is recommended that the warewasher is cleaned daily to ensure good hygiene in the warewasher.

#### 8.2.1 Interior cleaning

The interior of the warewasher should be cleaned after each service when the warewasher is drained down.

As a minimum **Classeq** recommends the

following are checked and cleaned (►3.1):

- Remove and clean top and bottom rinse and wash arms.
- Remove and clean primary filters
- Remove and clean secondary filters or drain plug.
- Clean interior of the wash tank with a sponge and/or brush for all apertures and outlets.
- Clean around the Hood labyrinth.
- Use a trigger spray bottle with a jet nozzle to spray the ball in the anti-syphon device.
- If required apply food grade grease to the door ball catch.

Ensure all arms and filters are refitted to the warewasher before turning it on.

#### 8.2.2 Exterior cleaning

Wipe the exterior of the warewasher with a damp (**NOT WET**) sponge.

Once dry, clean using a **STAINLESS STEEL** cleaning agent.

#### 8.3 Lime scale

For best results ensure your warewasher is operated with soft water ( $\leq 3^{\circ}\text{dH}$ ).

If your warewasher is connected to an external softener, ensure this is routinely 'regenerated' as per the instruction of the water softener.

If your warewasher has an internal water softener fitted ensure the salt level is maintained as per the instructions in this manual.

If your warewasher is operated with hard water without the relevant water treatment, the internal working and all water lines can become 'scaled', your results will deteriorate and the warewasher could be damaged. For more information on hard water refer to Appendix B (►12).



**Caution**

Damage to the warewasher caused by lime scale will **NOT** be covered by the manufacturer's warranty (►15).

## 8.4 Regular maintenance

### 8.4.1 Water softener salt (if fitted)

When the salt level inside the water softener reservoir gets low the refill salt indicator will flash on the display.



The salt should be replenished as soon as possible to avoid lime scale from building up in your warewasher.

To refill the salt reservoir follow the instructions below:

1. Lift the hood up of the warewasher.
2. Remove the basket ramp.
3. Open the salt reservoir cap at the front right hand corner of the wash tank.
4. Using the salt funnel supplied fill the reservoir with granulated salt.
5. Wipe away any excess or spilt salt from the cabinet and the reservoir opening.
6. Refit the cap to the reservoir, ensure that the cap is fitted flat and secure.

**Note:** The refill salt indicator may stay illuminated for up to 3 complete wash cycles after filling/refilling the salt reservoir with salt

7. Drain down the warewasher to remove the salt water.



**Warning**

**DO NOT** run the warewasher if there is no salt in the salt reservoir, as this will allow lime scale to build up, also any lime scale will invalidate your warranty

**DO NOT** add any chemicals, such as detergent or rinse aid to the reservoir. These will cause damage to the warewasher.

**Only use granulated salt** (max. grain size 5 – 7 mm). Salt tablets are not suitable.



**Caution**

If the reservoir cap is not properly secured, water and/or chemicals can leak in or out of the unit causing damage to the warewasher.

### 8.5 Descaling

You can de-scale the wash tank of your warewasher yourself with the help of the following notes; to de-scale the rinse boiler you will need to contact your service engineer or **Classeq**.



**Warning**

Wear protective clothing, protective gloves and protective goggles when handling chemicals and observe all safety notes and dosing recommendations printed on their packaging

In order to descale the wash tank follow the instructions below.

1. Remove the chemical tubes from the chemical bottles.
2. Place the ends tubes into a container of water.
3. Use the commissioning menu to prime the rinse aid and detergent pumps for at least 60sec (▶6.4) to draw water all the way into the warewasher.
4. Fill and drain the warewasher to remove any chemical residue.
5. Refill the warewasher.
6. Follow instructions on the chemical packaging to de-scale the wash tank.
7. Once the de-scale process is complete drain the warewasher.
8. Refill and drain the warewasher at least 3 times to remove any chemical residue.
9. Refit the chemical tubes to the bottles and prime the pumps (▶6.4).

## 9. Troubleshooting

If you believe the warewasher is not behaving as expected or has gone into error mode (Cycle indicator illuminated red) reset the warewasher, by pressing the on/off button, then follow the troubleshooting tips before requesting a service callout. The service support number can be found in the 'Useful contact details' section (▶ 17):



### Caution

Only authorized spare parts have to be used in the event of a breakdown

#### **NOTE:**

In the event of a service call being made under Warranty and it is found that the fault(s) are due to non-observance of instructions in this manual, the call will be charged at current rates.

### 9.1 Warewasher will not fill

Your warewasher operates a pulse fill function, this means that it will fill the rinse boiler, heat this to a pre-set temperature then transfer this water to the wash tank. During the fill stage the heating indicator will flash amber.

If your warewasher has been in this state for more than 30 minutes the error indicator will illuminate. Check the items below before requesting a service callout:

- Water supply hose is connected to your warewasher.
- Water supply is turned on.
- Water supply hose has not been trapped or kinked.
- Check that the site water supply has not been interrupted.
- Check the warewasher is turned on.
- Check the hood is closed.

### 9.2 Warewasher will not turn on

- Warewasher is connected to a mains power supply.
- Check power supply plug is turned on.
- On all ratings of warewasher check and reset circuit breaker in the site fuse board.
- If the fuse or breaker continues to

trip, do not reset and request a service callout.

### 9.3 Warewasher fills slowly

- Check water supply is turned fully on.
- Check water supply hose has not been trapped or kinked.
- Check that the site water supply has not been interrupted.
- Check site pressure is adequate (▶ 4.5.2).

### 9.4 Warewasher over filling

If your warewasher is over filling during the fill cycle attempt to drain the warewasher (▶ 7.9) and refill before isolating the warewasher and requesting a service callout.

### 9.5 Warewasher does not heat

- Warewasher is turned on (▶ 9.2).
- Warewasher able to fill (▶ 9.1).
- Enough time has been allowed for the warewasher to fill and heat (▶ 7.3).

### 9.6 Excessive foam in wash tank

- Chemicals are commercial warewasher grade.
- Chemical dosage is correct.
- Check wash tank has fully heated.

### 9.7 Cycle does not start

Your warewasher has a heat interlock that will delay the start of the wash cycle until all criteria have been met. When the criteria have been met the heat indicator will illuminate green and the cycle should start.

If this is not the case please check the below items before requesting a service callout.

- Warewasher is on.
- Enough time has been allowed for the warewasher to fill and heat (▶ 7.3).
- Wash tank is full of water.



used for the warewasher type.  
(▶ 7.9).

### 9.8 Cycle runs for a long time

Cycle runs for a long time but does not rinse, you will need to request a service call to identify the root cause of the problem. Please keep serial number and model information handy before call.

### 9.9 Warewasher does not rinse

If your warewasher runs through a full cycle, but does not rinse, you will need to request a service call to identify the root cause of the problem.

Please keep serial number and model information handy before call.

### 9.10 Warewasher over flowing

- Drain/stand pipe is correct for the warewasher (▶ 5.5).
- Site waste is not blocked.
- Warewasher waste hose is not kinked or blocked.
- Remove and clean all filters.
- Fully drain and refill warewasher.
- If the warewasher continues to overflow isolate the warewasher and request a service callout.

### 9.11 Poor wash results

- Soft water is supplied to the warewasher (▶ 4.5.2).
- The level of chemicals within the rinse aid and detergent bottles and the bottle weights and tubes are correctly positioned.
- Chemical dosing set to the correct concentration levels (▶ 6.3).
- Warewasher is regularly cleaned (▶ 8.2).
- Water softener regenerated (external) or salt reservoir full (internal)
- Glasses may need to be renovated.

### 9.12 Warewasher does not drain

- The drain/stand pipe is correct for the warewasher (▶ 5.5).
- Site waste is not blocked.
- Warewasher waste hose is not kinked or blocked.
- Correct drain procedure is being

## 10. Decommissioning

If for any reason you require to remove or decommission your warewasher do so in accordance with local and national regulations.

As a minimum **Classeq** recommends the following procedure is followed.

Prior to removing any chemicals refer to all safety statements on chemical bottles for dealing with any spillage.

- Remove chemical tubes from the chemical bottles, ensuring the bottles are then capped to prevent any further spillage.
- Ensure the warewasher is fully drained (► 7.9). Once completed remove the waste hose from the drain standpipe; ensure any spilt liquid is dried prior to advancing to the next step.
- Turn off the mains electrical supply at wall / isolator / junction box

When disconnecting your warewasher from the mains electrical supply:

- Warewashers hard wired (*i.e. no plug*), this must be disconnected in accordance with local and national regulations; **Classeq** recommends this is performed by a qualified electrician.



- Once the electrical supply has been disconnected, ensure the equipotential wire is removed from the stud at the rear of the warewasher.
- Turn off the water supply to the warewasher and disconnect the water supply hose from mains water supply, ensuring any spillage is dried prior to moving onto next step.
- Remove the front lower panel using a 8mm spanner to release two M5 hex head screws at the bottom.
- Now locate the '*Boiler drainage hose*' as shown. Ensure this protrudes from the front of the warewasher and you have a container large enough to hold 8 litres of water.



**Warning**

If the warewasher is being drained immediately after use, water draining from the '*Boiler drainage hose*' may reach up to **95°C**.

- Loosen the jubilee clip and remove the drain plug, ensuring the water flows into the container mentioned above. Once fully drained replace the drain plug and retighten the jubilee clip.
- Replace the front panel, and ensure all cables and hoses are secured to the warewasher to prevent tripping hazards. The warewasher is now ready to be removed.



**RECYCLING** If you are recycling or disposing of your warewasher, you must ensure this is done in accordance with local and national regulations.

## 11. Appendix A – Water softener settings

| Water softener setting | °dH         | °e / °clark | °fH  | ppm |
|------------------------|-------------|-------------|------|-----|
| h00                    | Deactivated |             |      |     |
| h01                    | 1           | 0.8         | 0.6  | 18  |
| h02                    | 2           | 1.6         | 1.1  | 36  |
| h03                    | 3           | 2.4         | 1.7  | 54  |
| h04                    | 4           | 3.2         | 2.2  | 71  |
| h05                    | 5           | 4.0         | 2.8  | 89  |
| h06                    | 6           | 4.8         | 3.4  | 107 |
| h07                    | 7           | 5.6         | 3.9  | 125 |
| h08                    | 8           | 6.4         | 4.5  | 143 |
| h09                    | 9           | 7.2         | 5.0  | 161 |
| h10                    | 10          | 8.0         | 5.6  | 179 |
| h11                    | 11          | 8.8         | 6.2  | 196 |
| h12                    | 12          | 9.6         | 6.7  | 214 |
| h13                    | 13          | 10.4        | 7.3  | 232 |
| h14                    | 14          | 11.2        | 7.8  | 250 |
| h15                    | 15          | 12.0        | 8.4  | 268 |
| h16                    | 16          | 12.8        | 9.0  | 286 |
| h17                    | 17          | 13.6        | 9.5  | 303 |
| h18                    | 18          | 14.4        | 10.1 | 321 |
| h19                    | 19          | 15.2        | 10.6 | 339 |
| h20                    | 20          | 16.0        | 11.2 | 357 |
| h21                    | 21          | 16.8        | 11.8 | 375 |
| h22                    | 22          | 17.6        | 12.3 | 393 |
| h23                    | 23          | 18.4        | 12.9 | 411 |
| h24                    | 24          | 19.2        | 13.4 | 428 |
| h25                    | 25          | 20.0        | 14.0 | 446 |
| h26                    | 26          | 20.8        | 14.6 | 464 |
| h27                    | 27          | 21.6        | 15.1 | 482 |
| h28                    | 28          | 22.4        | 15.7 | 500 |
| h29                    | 29          | 23.2        | 16.2 | 518 |
| h30                    | 30          | 24.0        | 16.8 | 536 |

## 12. Appendix B – Water hardness explained

Water hardness occurs because certain chemicals in the rocks through which it passes on its way to the consumer are slowly dissolved into the water.

The problem shows itself in two forms. First, when hard water is heated the chemicals come out of solution and appear as solid particles (lime scale) that are carried round the warewasher. These particles are formed most quickly at the hottest part of the warewasher – normally the rinse element and the rinse tank in general. This is why the rinse tank is the best place to look to judge if lime scale is being formed in a warewasher.

Second, most commercial chemicals operate much less efficiently in hard water, and this will often show as poor results or failure to remove tannin stains, or condensation on glasses. Tannin stains appear to cling to the hard water film in the drink, which then clings to the surface of the cup or saucer. With soft water this is not the case.

Some types of hard water do not produce lime scale when heated, but it will still reduce the performance of the chemicals, as mentioned above. This is known as permanent hardness. Temporary hardness is when the hardness can be largely removed by conversion into lime scale by boiling.

If lime scale is produced inside a warewasher it will cause a number of maintenance problems, for example:

- Coating of element leading to slow heating and element failure
- Blockage of rinse jets showing as poor results
- Wear of bushes in centre boss, showing as poor results and possibly wash water passing backwards into the rinse system.
- Blockage of rinse-aid injection point in boiler.
- White marks may appear on glasses, dishes and cutlery.



- Dishes or cups may appear dirty even after a wash. Especially coffee or tea cups.
- Discolouration of inside of warewasher, making cleaning difficult.



- Blockage of hoses due to the deposit “furring up” the inside of the hose.

When lime scale is found, it must be removed with commercial De-scale, used with care in accordance with the instructions on the product. The descale instructions in this manual should always be followed. The rinse tank is difficult to de-scale and may require a service engineer.

Your local water board should be able to tell you if the water in your area is hard or soft. As a guide refer to the map in Appendix C (►13).

### 13. Appendix C – Water hardness map

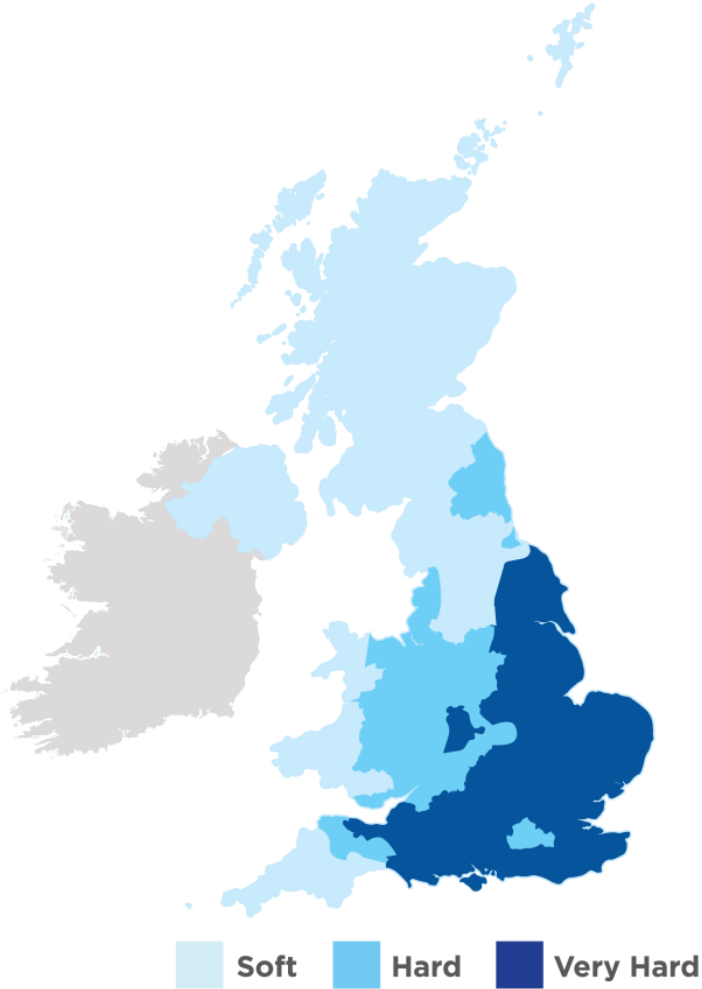

Map 1 - Water hardness map<sup>3</sup>

For more detailed information regarding your water hardness, please contact your water supplier.

---

<sup>3</sup> Correct at time of going to print

# 14. Appendix D – Warewasher specifications

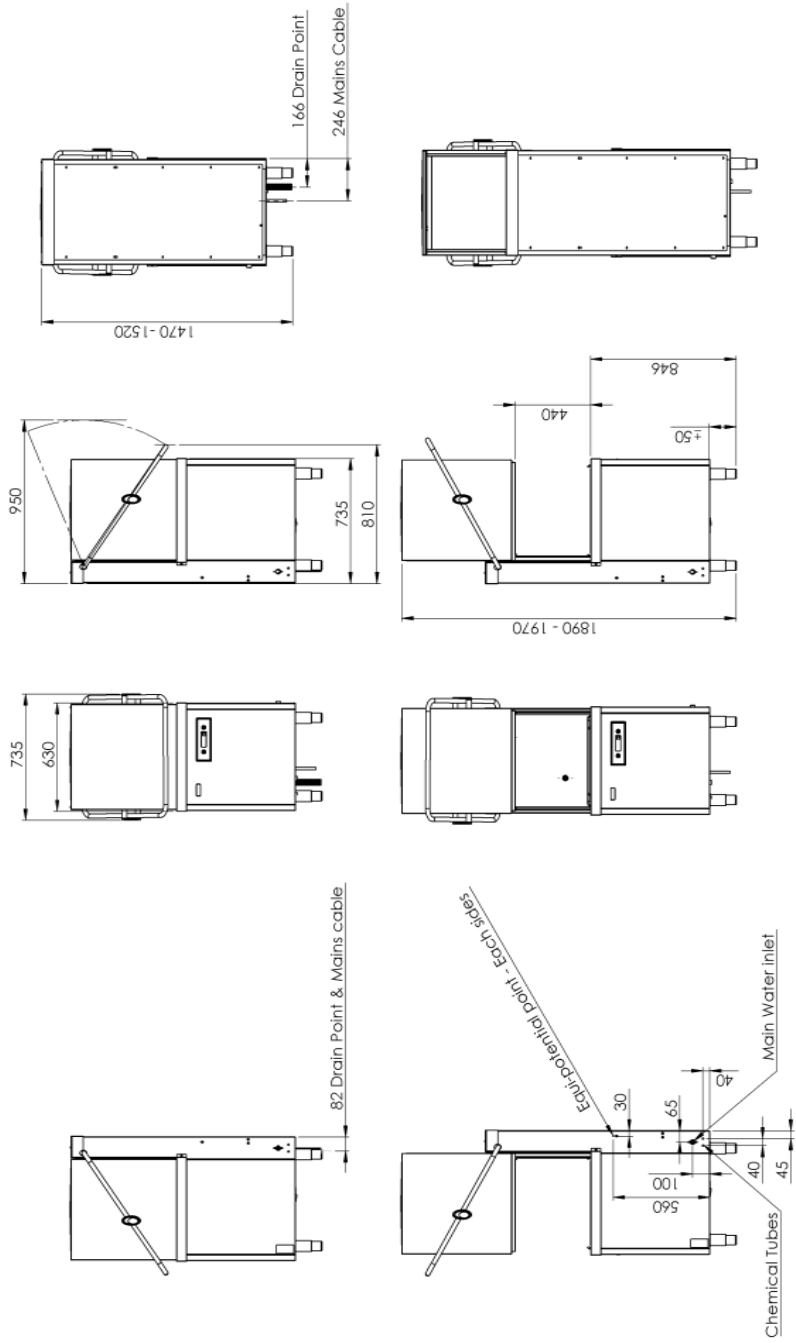

## 15. Parts and Labour warranty

### ***Classeq Ltd.***

#### Parts and Labour Warranty Terms

The user is entitled to free replacement and fitting of any part found to be faulty in material or workmanship, including any parts rendered inoperative by the effect of a faulty component, for a period of one year, or as specified by the vendor at the time of purchase.

#### Exceptions

All faults or conditions caused by Operator misuse, including (but not exclusively):

- Incorrect Installation.
- No fault found.
- Problems with electricity supply or plumbing e.g. water and waste.
- Failure to follow instructions in the User Handbook.
- Use of incompatible chemicals or chemical set at incorrect concentration.
- Drain pump or drain system blocked or damaged by foreign bodies.
- Wash pumps damaged due to foreign bodies entering the wash system.
- Use of un-softened (hard) water. The use of a faulty water softener or the failure to properly regenerate a water softener.
- Use of excessive force on the warewasher, e.g. switches etc.
- The cost of replacing any item found to be lost or missing.
- Use of non-compatible cleaning materials.
- Incorrect assembly after cleaning.
- Damage to warewasher caused by any 3<sup>rd</sup> party.





**17. Useful contact details**

## Accessories and Extras

### Detergents and Hygiene Products

| Application            | Product Name                                   | Quantity | Order Code |
|------------------------|--|----------|------------|
| Glass washing Products | Super clean glass washing detergent            | 2x5L     | 20003020   |
|                        | G3 glass rejuvenator                           | 10kg     | 20003018   |
|                        | Super shine glass washing rinse aid            | 2x5L     | 20003026   |
|                        | Glasswasher starter pack glasswasher detergent | 2x5L     | 20003306   |
|                        | Glasswasher starter pack rinse aid             | 2x5L     |            |
| Dishwashing Products   | Super clean dishwashing detergent              | 2x5L     | 20003007   |
|                        | Super clean dishwashing detergent              | 20L      | 20003040   |
|                        | Super shine dishwashing rinse aid              | 2x5L     | 20003013   |
|                        | Super shine dishwashing rinse aid              | 20L      | 20003011   |
|                        | Dishwashing starter pack detergent             | 2x5L     | 20003306   |
|                        | Dishwashing starter pack rinse aid             | 2x5L     |            |
|                        | Super descaler                                 | 2x5L     | 20003006   |
| Salt                   | Table Salt DuoMatik                            | 25kg     | 20005167   |
|                        | Granulated                                     | 25kg     | 20005166   |

### Stands



| Product Name                                      | Order Code |
|---|------------|
| 400mm Stainless steel 475(w) x 497(d) x 410(h)    | 30007363   |
| 500mm Stainless steel 575(w) x 580(d) x 400(h)    | 30007365   |
| 350mm Steel coated stand 403(w) x 462(d) x 415(h) | 30007235   |
| 400mm Steel coated stand 435(w) x 490(d) x 415(h) | 30007236   |
| 500mm Steel coated stand 543(w) x 565(d) x 440(h) | 30007237   |

### Baskets

| Product Name                    | Order Code |
|---------------------------------|------------|
| 400mm <sup>2</sup> open basket  | 30001165   |
| 500mm <sup>2</sup> open basket  | 30001197   |
| 400mm <sup>2</sup> plate basket | 30001166   |
| 500mm <sup>2</sup> plate basket | 30001198   |



## Basket Inserts

| Product Name                 | Order Code |
|------------------------------|------------|
| Single cutlery holder        | 30001167   |
| 400mm plate rack             | 30007213   |
| 8 Compartment cutlery holder | 30001199   |



## Water treatment



| Description         | Order code             |          |
|---------------------|------------------------|----------|
| Under counter range | 8 litre                | 20004396 |
|                     | 12 litre               | 20004397 |
|                     | 16 litre               | 20004398 |
|                     | 20 litre               | 20004399 |
|                     | Automatic (Cold water) | 20003213 |
|                     | Automatic (Hot water)  | 20003217 |

## Accessories

| Description   | Order Code |
|---|------------|
| Boostermatic Pressure Pump (where water pressure is below 45psi/3bar) | 30007219   |
| Fixing Bracket For pump   | 30009322   |
| Mixer Valve For hot water installations                               | 30007229   |

## Service and Maintenance Contracts

Enjoy complete peace of mind with **Classeq's** range of tailored service contracts. We will be happy to discuss your requirements and provide a proposal which will cater for all your ware washing service needs.

|                    |   |
|--------------------|---|
| Four Star<br>★★★★  | Break down cover only. Call out and labour included. All replacement parts will be charged. |
| Five Star<br>★★★★★ | Break down cover with call out, labour and parts included                                   |

To help when contacting please quote the serial number and model of warewasher

---

**Classeq Ltd.**  
Classeq house  
Beacon Business Park  
Beacon Way  
Stafford  
ST18 0DG  
United Kingdom

Document number: 30013647

Revision: B

Date: 20-12-2017

Language: English

**Original instructions**