



INSTRUCTION REF: IN166

ISSUE NO. 5

DATE - 05.08.14

Page 1 of 23

TELEPHONE: SERVICE (44) 01332 875665  
FAX: SERVICE (44) 01332 875536

## **INSTRUCTIONS**

### **MODEL: P4BO**

**SAFETY INSTRUCTIONS**

**INSTALLATION INSTRUCTIONS**

**OPERATION INSTRUCTIONS**

**MAINTENANCE INSTRUCTIONS**

**CONVERSION INSTRUCTIONS**

**FAULT FINDING**

**TECHNICAL DATA**

**PARTS LIST**

**SPARES LIST**

**WARRANTY INFORMATION**

### **Customer Information**

MODEL NUMBER: \_\_\_\_\_  
SERIAL NUMBER: \_\_\_\_\_  
PURCHASE DATE: \_\_\_\_\_  
DISTRIBUTOR: \_\_\_\_\_



INSTRUCTION REF: IN166

ISSUE NO. 5

DATE - 05.08.14

Page 2 of 23

TELEPHONE: SERVICE (44) 01332 875665  
FAX: SERVICE (44) 01332 875536

## **SAFETY INSTRUCTIONS**

### **IMPORTANT, PLEASE READ INSTRUCTIONS FULLY BEFORE USE**

**THIS APPLIANCE IS ONLY FOR PROFESSIONAL USE AND MUST ONLY BE USED BY QUALIFIED PEOPLE.**

Attention should be drawn to the fact that parts of this unit by necessity, will get VERY HOT, and will cause burns if touched accidentally. Therefore it is the responsibility of the supervisor or equivalent to provide SUITABLE PROTECTIVE CLOTHING for the user.

**THIS APPLIANCE MUST BE FITTED AND TESTED BY A REGISTERED FITTER BEFORE USE.**

The unit should be installed in compliance with the INSTALLATION INSTRUCTIONS and the NATIONAL REGULATIONS in force at the time. Particular attention should be paid to the Gas Safety (Installation and Use) Regulations and the Health and Safety at Work Act.

Each appliance requires a flow of fresh air for combustion. Under no circumstances should air vents on the appliances, or air vents installed by the fitter in the room of the appliance to supply combustion air, be altered or omitted in any way.

To prevent shocks, all appliances whether gas or electric, must be earthed.

**ANY GAS CONVERSIONS NEEDED TO BE MADE TO THE PRODUCT MUST BE CARRIED OUT BY A CORGI REGISTERED ENGINEER**

To avoid scratching the highly polished exterior surface of this equipment whilst in transit, the protective film on the exterior surfaces has NOT been removed.

It is IMPORTANT that this protective film is peeled off before the equipment is used.



**INSTRUCTION REF: IN166**

**ISSUE NO. 5**

**DATE - 05.08.14**

**Page 3 of 23**

**TELEPHONE: SERVICE (44) 01332 875665**  
**FAX: SERVICE (44) 01332 875536**

**MODEL P4BO**

The products stated above are designed and built to comply with the latest versions of the following standards:

**BS EN 203-1**

**BS EN 203-2-1**

**BS EN 203-2-2**

The products have been CE-marked in compliance with the **European Gas Directive (90/396/EEC)**

### **INSTALLATION INSTRUCTIONS**

**ALL APPLIANCES MUST BE FITTED AND OR CONVERTED BY A REGISTERED INSTALLER, IN ACCORDANCE WITH CURRENT REGULATIONS.**

#### **INSTALLATION**

Before installation check data plate on rear of unit to ensure appliance is suitable for gas supply available.

During installation provision must be provided for combustion air to the appliance through base and rear of appliance. This should not be blocked at any time. This appliance should be installed with sufficient ventilation to prevent the occurrence of unacceptable concentrations of substances harmful to health in the room in which it is installed.

#### **POSITIONING**

The appliance must not be installed on or against combustible surfaces – minimum clearances must be :

Rear 150mm (6")

Sides 150mm (6")

Hotplate to combustible material 1525mm (60")

All local fire regulations should be observed.

It is recommended that the appliance be sited below a ventilating hood preferably of the extractor type incorporating a grease filter.



**INSTRUCTION REF: IN166**

**ISSUE NO. 5**

**DATE - 05.08.14**

**Page 4 of 23**

**TELEPHONE: SERVICE (44) 01332 875665**  
**FAX: SERVICE (44) 01332 875536**

The cooker is manufactured with four castors two of which are braked. Caution should be taken when manipulating or moving the unit. The appliance should be attached to a wall with a chain to restrict the movement of the unit once connected to the gas supply. When the unit is installed in position the brakes should be on.

Ensure the appliance is level, by placing a spirit level on the shelf in the oven, not on the hotplate! All four castors are adjustable. To alter the height of the unit loosen the locking grub screw with an M3 allen key.

Next turn the large nut on the wheel assembly to either raise or lower the unit.

When you are happy with the height, tighten the locking grub screw with the M3 allen key.

Locking  
Grub Screw

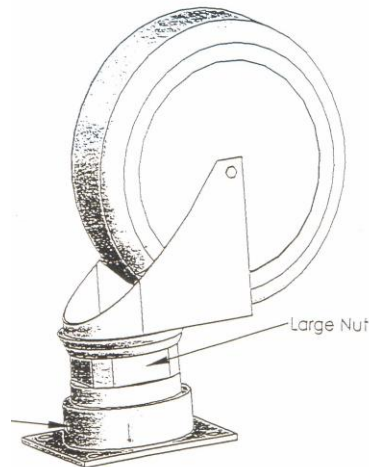

The oven doors are held shut by adjustable roller catches. When installing the appliance ensure the catches are set to allow the door to close firmly. To adjust the catch, use a screwdriver to press in roller to below the plate, turn clockwise to adjust downward, and anti-clockwise to lift the roller.



**INSTRUCTION REF: IN166**

**ISSUE NO. 5**

**DATE - 05.08.14**

**Page 5 of 23**

**TELEPHONE: SERVICE (44) 01332 875665**  
**FAX: SERVICE (44) 01332 875536**

### **GAS CONNECTION**

The size of the supply pipe should be no less than 3/4" B.S.P. and an easily accessible isolation tap fitted close to the appliance in the gas line. Although a rigid connection is recommended. An approved armoured flexible pipe may be used in conjunction with a straining cable.

Before the appliance is commissioned the gas safety regulations require that all connections on the gas line are tested for gas soundness between the gas meter and the appliance.

All packing and protective film must be removed from panels etc. prior to commissioning the appliance.

All gas appliances must be fitted by a competent person to gas safety regulations in force.





**TELEPHONE: SERVICE (44) 01332 875665**  
**FAX: SERVICE (44) 01332 875536**

## **OPERATING INSTRUCTIONS**

**FOR FITTING INSTRUCTIONS SEE INSTALLATION SECTION.**

### **Operating the hob**

All burners are fitted with flame failure devices.

1. To light hob unit turn knob to 
2. Press in and ignite gas with a match, keep knob held in for 15-20 seconds.
3. Release knob, gas should stay lit, if gas goes out repeat stage 2
4. The burner is now on full gas, to turn gas down turn knob anti-clockwise,  
this is the  lowest setting, which is factory set.
5. To turn burners off, turn knob clockwise all the way round.

Parry recommends that the hob is used only with pans that have a minimum diameter of 120mm, and up to a maximum of 295mm diameter. This ensures that there is satisfactory combustion, and the pan is stable as it sits on the finger of the pan support.

### **Operating the oven**

1. To light oven, open door, turn oven knob to approximate gas mark 5 and hold tap knob in, at the same time press the piezo ignitor button on bottom of the oven.
2. After pressing button 2-3 times burner should light.
3. Keep oven knob depressed for 15-20 seconds.
4. Release knob and flame should remain lit, if not repeat above sequence.
5. If burner goes out refer to fault finding chart.
6. When burner stays on oven is ready for use, select gas mark required, turn knob to setting, oven flame will decrease when desired temperature is reached.

Please take care when opening and closing the doors of an oven that has been turned on. Surfaces and handles will get hot. The surfaces within the oven chamber will be very hot so it is advisable to wear oven gloves to protect from burns that may be incurred from touching hot surfaces within the oven.

We advise these appliances should not be left unattended while switched on.



**INSTRUCTION REF: IN166**  
**ISSUE NO. 5**  
**DATE - 05.08.14**  
**Page 7 of 23**

**TELEPHONE: SERVICE (44) 01332 875665**  
**FAX: SERVICE (44) 01332 875536**

These appliances are for professional use by qualified people only. There are no user serviceable parts.

Users should be made aware, and take into consideration the danger of opening the oven door when the cooking chamber is hot.

A drip tray is fitted beneath the hob burners to catch any spillage, during normal use, this tray may get hot. Only remove when tray has cooled or with suitable gloves.



**TELEPHONE: SERVICE (44) 01332 875665**  
**FAX: SERVICE (44) 01332 875536**

There are three shelf positions in the oven, the following guide is only intended as a guide to temperature in the centre of the oven. It is strongly recommended that the user makes note of best results, temperatures can vary as much as 20°c hotter at top of oven and 30°c cooler at the bottom of the oven.

These temperatures are measured in an empty oven.

<b>MARK</b>	<b>1</b>	<b>2</b>	<b>3</b>	<b>4</b>	<b>5</b>	<b>6</b>	<b>7</b>	<b>8</b>	<b>9</b>
°C	130	150	170	185	203	220	240	260	280
°F	266	300	338	365	397	428	464	500	536

<b>USAGE</b>	<b>PRODUCT</b>	<b>GAS TEMP</b>
HIGH TEMP.ROASTING	MEAT OR POULTRY	6 OR 7
LOW TEMP.ROASTING	MEAT OR POULTRY	3
HIGH TEMP.BAKING	BREAD OR SCONES	8
LOW TEMP. BAKING	SLAB CAKE	2
PUDDINGS	MILK PUDDING BAKED CUSTARD	3
PASTRY	SHORT CRUST PLATE TARTS FLAKY	7

Parry advise that only pans with between a maximum external diameter of 29cm and a minimum external diameter of 10cm are used on the hob burners of this appliance to ensure stability and satisfactory combustion with the pan supports provided





**INSTRUCTION REF: IN166**

**ISSUE NO. 5**

**DATE - 05.08.14**

**Page 9 of 23**

**TELEPHONE: SERVICE (44) 01332 875665**  
**FAX: SERVICE (44) 01332 875536**

### **MAINTENANCE INSTRUCTIONS**

**MAINTENANCE AND SERVICE MUST ONLY BE UNDERTAKEN BY REGISTERED FITTERS.**

**PLEASE NOTE THE LOW RATE ADJUSTER ON THE UNIT HAS BEEN FACTORY SET AND SHOULD NOT BE ADJUSTED UNLESS BY A QUALIFIED ENGINEER IN WHICH CASE THE LOW RATE ADJUSTER SHOULD BE RE-SEALED.**

Parry recommends that this unit is serviced at least every 6 months

As part of a full service we recommend the following checks are carried out.

- Before any maintenance isolate the appliance from the gas supply
- Examine and clean all burner and flame retention ports.
- Using a combination of brushes, remove dust and lint from within the primary air ports venturi and burners. Check the burner aeration to ensure it is clear of debris.
- Clean burner injectors ensuring orifices are not enlarged or damaged.
- Stiff gas controls can in some instances be greased. Please ensure the correct type of grease is used.
- Check any ignition electrodes and high tension leads where fitted. Clean and adjust where necessary
- Check Door seal for damage and condition.
- Reconnect gas supply and test all disturbed gas connections for gas tightness using a non corrosive leak detection fluid.
- Check the appliance burner operating pressure, heat input rating or where necessary both.



**INSTRUCTION REF: IN166**

**ISSUE NO. 5**

**DATE - 05.08.14**

**Page 10 of 23**

**TELEPHONE: SERVICE (44) 01332 875665**  
**FAX: SERVICE (44) 01332 875536**

### **CLEANING**

It will be found that it takes less time and effort to clean the hob every time it has been used, particularly whilst still warm before grease and spillages are burnt on. Proprietary cleaners must be used with care – they are highly corrosive and may cause damage to surfaces and components. The stainless outer panels require a wipe down with warm soapy water.

**DO NOT USE SCOURING PADS.**

The internal walls of the oven have been vitreous enamelled to make them easy to clean. The oven has two wire shelves and one vitreous enamelled bottom tray. These can be removed for cleaning but the lower tray must be in position when the appliance is being used.



INSTRUCTION REF: IN166

ISSUE NO. 5

DATE - 05.08.14

Page 11 of 23

TELEPHONE: SERVICE (44) 01332 875665

FAX: SERVICE (44) 01332 875536

### FAULT FINDING

FAULT	POSSIBLE CAUSE	REMEDY
<b>HOB</b>		
Incorrect flame picture, flame lift or noisy burner	Incorrect burner pressure, Blocked or partially blocked injector. Inadequate ventilation. Burner faulty/corroded/blocked	Check/adjust burner pressure Check /clean injector, Check ventilation. Check / clean burner and replace as necessary.
Burners will not stay alight	Faulty connection at thermocouple-valve, incorrectly located	Remake connection, reposition thermocouple
Burner goes out when turned to "low"	Blockage in tap	Clean and re-grease
Irregular flame	Burner ring/cap not correctly located, or low pressure	Relocate and check pressure at test point.
<b>OVEN</b>		
Failure to ignite	Dirt or grease broken or loose connection	Clean reconnect / replace H.T.Lead
	Incorrect spark gap	Set gap 3-4mm
Burner fails on low rate	Loose Thermocouple	Replace
	Faulty Magnet in F.F.D.	Replace thermostat
Burner fails on low rate	Thermocouple out of position.	Reposition



TELEPHONE: SERVICE (44) 01332 875665  
FAX: SERVICE (44) 01332 875536

## **REPLACING FAULTY COMPONENTS**

### **For Gas Safe Engineers only**

**HOB TAP-** Remove pan supports, pull off control knobs and unclip fascia panel. Disconnect burner supply tube and thermocouple. Undo the 2 screws securing the tap to the rail. Check sealing washer and replace if necessary. Assemble in reverse order.

**HOB BURNER/THERMOCOUPLE** – Remove Pan Supports and Burner caps. Remove the solid top tray. Disconnect thermocouple from rear of tap. Undo locknut on burner mounting channel. Assemble in reverse order.

**OVEN THERMOSTAT** - Proceed as for hob tap. Slide thermostat phial from housing inside oven. Remove through hole in the top of the oven on right hand side. Assemble in reverse order.

**OVEN THERMOCOUPLE** - Remove the bottom oven tray. Inside the oven disconnect the thermocouple from the extension piece. Undo locknut holding thermocouple to oven burner. Assemble in reverse order. Ensure locknut is securely tightened.

**OVEN BURNER/IGNITION** - Remove oven base. Disconnect oven supply tube, H.T.lead and thermocouple. Burner is held in by 2 screws. Piezo spark generator is secured by a locknut. Electrode secured to burner bracket by centre screw.



TELEPHONE: SERVICE (44) 01332 875665  
 FAX: SERVICE (44) 01332 875536

<b>Instruction Ref</b>	<b>CONVIN34</b>	<b>Issue No.</b>	<b>4</b>	<b>Date updated</b>	<b>07/09/2011</b>
------------------------	-----------------	------------------	----------	---------------------	-------------------



## NAT GAS - Conversion Instructions

<b>Product</b>	<b>P4BOP- Paragon 4 burner oven</b>
----------------	-------------------------------------

**For use with models with the following serial numbers**

<b>Model</b>	<b>From</b>	<b>To</b>
P4BOP-4	11011813	

**These instructions can be used for converting from LPG to Natural Gas**

LPG units are designed and tested in accordance with all current regulations enforced to run on the following gases only

Nat Gas G20 @ 20mbar 8" W.G.

Nat Gas G25 @ 25mbar 10" W.G. (Must be converted by manufacturers only)

**PLEASE NOTE**

This conversion must be carried out by a Gas Safe Registered Engineer.

**This conversion kit includes**

	<b>Description</b>	<b>Product Code</b>	<b>Quantity</b>
<b>Hob valve bypass screw</b>	NAT hob valve bypass screw stamped with 85	COPBPS-85	4
<b>Hob burner injector</b>	NAT hob valve injector stamped with 185	HOBINJECT185	4
<b>Oven valve bypass screw</b>	NAT oven burner injector stamped with 60	COPBPS-60	1
<b>Oven burner injector</b>	NAT oven burner injector stamped with 150	INJECT150	1
<b>Labels</b>		NAT GAS only + G20	1
<b>Instructions</b>		CONVIN34-4	1



TELEPHONE: SERVICE (44) 01332 875665  
 FAX: SERVICE (44) 01332 875536

<b>Instruction Ref</b>	CONVIN35	<b>Issue No.</b>	4	<b>Date updated</b>	07/09/2011
------------------------	----------	------------------	---	---------------------	------------



## LPG – Conversion Instructions

<b>Product</b>	P4BO – Paragon 4 Burner Oven
----------------	------------------------------

### For use with models with the following serial numbers

<b>Model</b>	<b>From</b>	<b>To</b>
P4BO-4	11011812	

### **These instructions can be used for converting from Natural Gas to LPG**

LPG units are designed and tested in accordance with all current regulations enforced to run on the following gases only

Propane G31 @ 37mbar 14.8" W.G.

### **PLEASE NOTE**

This conversion must be carried out by a Gas Safe Registered Engineer.

### **This conversion kit includes**

	<b>Description</b>	<b>Product Code</b>	<b>Quantity</b>
<b>Hob valve bypass screw</b>	LPG hob valve bypass screw stamped with 50	COPBPS-50	4
<b>Hob burner injector</b>	LPG hob burner injector stamped with 0.92	HOBINJECT105	4
<b>Oven valve bypass screw</b>	LPG oven valve bypass screw stamped with 40	COPBPS-40	1
<b>Oven burner injector</b>	LPG oven burner injector stamped with 0.99	INJECT099	1
<b>Labels</b>		G31 ONLY,	1
<b>Instructions</b>		CONVIN35-4	1



TELEPHONE: SERVICE (44) 01332 875665  
FAX: SERVICE (44) 01332 875536

### Conversion Procedure for P4BO

#### Warning

Ensure the appliance is isolated from the gas supply before commencing conversion

(Please note P4BO only has four hob burners)

Remove pan support and burner caps.



Lift off aluminium burner plates.



Remove the solid top plate.



Using an 8mm spanner remove burner injector. Replace with injector from conversion kit. Replace solid top plate, aluminium burner plates and burner caps.











**TELEPHONE:** SERVICE (44) 01332 875665  
**FAX:** SERVICE (44) 01332 875536

<p>Remove the tap knobs to allow the fascia to unclip.</p>		
<p>Remove low rate screws in tap body and replace with low rate screw from the conversion kit.</p>		
<p>Converting the oven burner</p>		
<p>Unscrew the 15mm nut on the jet that goes into the burner</p>		
<p>Unwind the jet out of the burner</p>		





TELEPHONE: SERVICE (44) 01332 875665  
FAX: SERVICE (44) 01332 875536

Replace jet with the jet for the required gas	
Tighten up the 15mm nut	
Unwind the bypass screw on the oven valve and replace with the bypass screw for the required gas	
Connect the unit back to the gas supply Test for gas soundness Replace the facia and knobs accordingly	
<b>When conversion is complete affix new data label and gas type label supplied with the conversion kit, detailing type of gas and pressure.</b>	



TELEPHONE: SERVICE (44) 01332 875665  
FAX: SERVICE (44) 01332 875536

**TECHNICAL DETAILS : MODEL P4BO****Hob Burner**

GAS	OPERATING PRESSURE	TOTAL HEAT INPUT (NET)
NATURAL G20	20mb / 8" W.G.	5.557 KW = 18959 Btu/h
PROPANE G31	37mb / 14.8" W.G.	4.351 KW = 14846 Btu/h
G25	25mb / 10" W.G.	4.973 KW = 16966 Btu/h

GAS RATE	m <sup>3</sup> /h	ft <sup>3</sup> /h	lb/h	kg/h
NATURAL G20	0.588 M <sup>3</sup> /HR	20.765 FT <sup>3</sup> /HR		
PROPANE G31	0.178 M <sup>3</sup> /HR	6.286 FT <sup>3</sup> /HR	0.691 LB/HR	0.313 KG/HR
G25 @ 25mbar	0.612 M <sup>3</sup> /HR	21.613 FT <sup>3</sup> /HR		

BURNER LOW RATE	M <sup>3</sup> /HR
NATURAL G20	0.125 M <sup>3</sup> /HR
PROPANE G31	0.041 M <sup>3</sup> /HR
G25	0.125 M <sup>3</sup> /HR

**Oven Burner**

GAS	OPERATING PRESSURE	TOTAL HEAT INPUT (NET)
NATURAL G20	20mb / 8" W.G.	3.506 kW = 11962 Btu/h
PROPANE G31	37mb / 14.8" W.G.	3.496 kW = 11927 Btu/h
G25	25mb / 10" W.G.	3.201 kW = 10923 Btu/h

GAS RATE	m <sup>3</sup> /h	ft <sup>3</sup> /h	lb/h	kg/h
NATURAL G20	0.371 m <sup>3</sup> /h	13.102 ft <sup>3</sup> /h		
PROPANE G31	0.143 m <sup>3</sup> /h	5.050 ft <sup>3</sup> /h	0.555 lb/h	0.252 kg/h
G25 @ 25mb	0.394 m <sup>3</sup> /h	13.914 ft <sup>3</sup> /h		



INSTRUCTION REF: IN166

ISSUE NO. 5

DATE - 05.08.14

Page 19 of 23

TELEPHONE: SERVICE (44) 01332 875665  
FAX: SERVICE (44) 01332 875536

**Total Unit**

<b>GAS</b>	<b>OPERATING PRESSURE</b>	<b>TOTAL HEAT INPUT (NET)</b>
<b>NATURAL G20</b>	20mb / 8" W.G.	29.059 kW = 99148 Btu/h
<b>PROPANE G31</b>	37mb / 14.8" W.G.	24.493 kW = 83571 Btu/h
<b>G25</b>	25mb / 10" W.G.	26.146 kW = 89211 Btu/h

<b>GAS RATE</b>	<b>m<sup>3</sup>/h</b>	<b>ft<sup>3</sup>/h</b>	<b>lb/h</b>	<b>kg/h</b>
<b>NATURAL G20</b>	3.075 m <sup>3</sup> /h	108.593 ft <sup>3</sup> /h		
<b>PROPANE G31</b>	1.002 m <sup>3</sup> /h	35.385 ft <sup>3</sup> /h	3.889 lb/h	1.764 kg/h
<b>G25 @ 25mbar</b>	3.218 m <sup>3</sup> /h	113.643 ft <sup>3</sup> /h		
<b>AIR FLOW RATE FOR COMBUSTION 20m<sup>3</sup>/h</b>		32.18 m <sup>3</sup> /h		



TELEPHONE:  
FAX:

SERVICE (44) 01332 875665  
SERVICE (44) 01332 875536

**PARTS LIST**  
**MODEL P4B0**

**Side View**

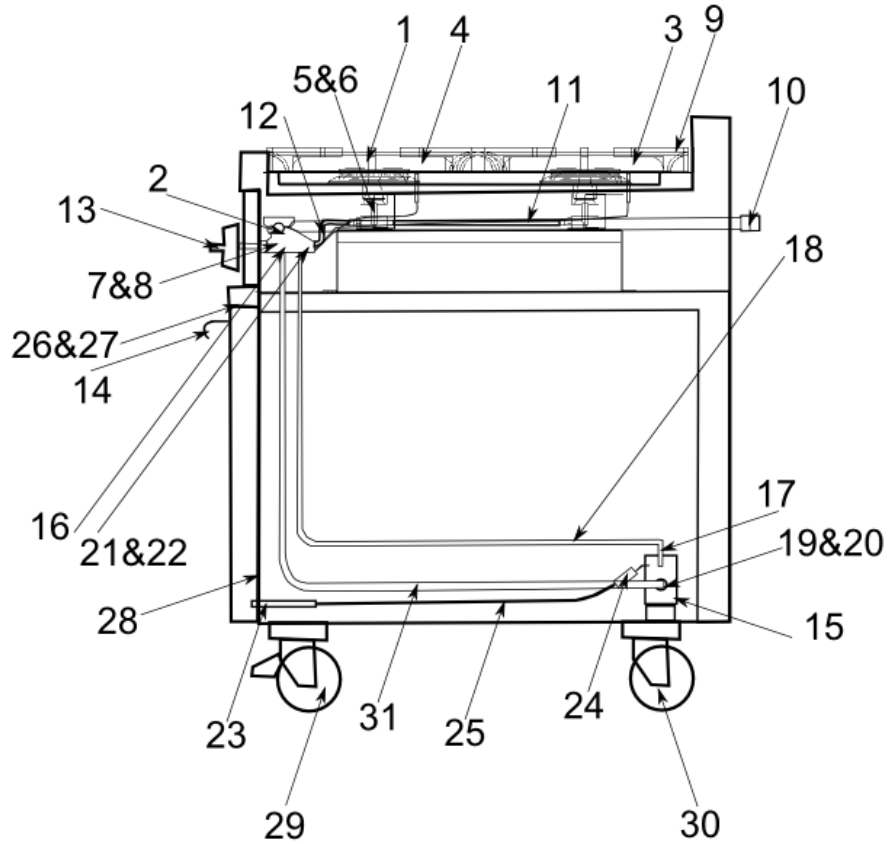

**Top View**

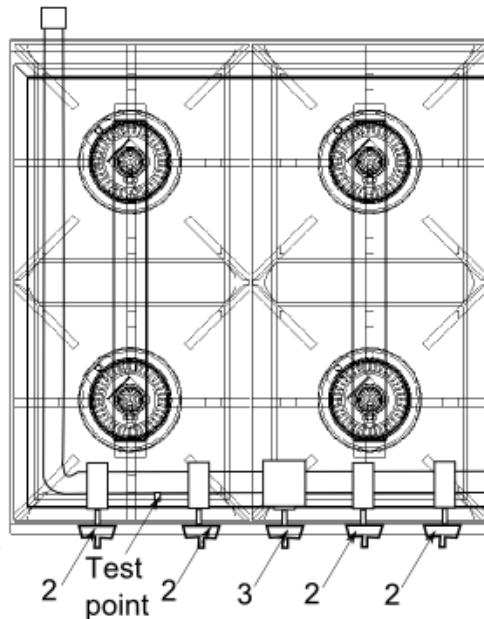



**INSTRUCTION REF: IN166**

**ISSUE NO. 5**

**DATE - 05.08.14**

**Page 21 of 23**

**TELEPHONE: SERVICE (44) 01332 875665**

**FAX: SERVICE (44) 01332 875536**

<b>Item Number</b>	<b>Components</b>	<b>P4BO</b>	
1	New hob burner	BURNRHOB	x4
2	New hob valve	GASTAPHOB	x4
3	New hob rear thermocouple	THCP600ISP	x2
4	New hob front thermocouple	THCP320ISP	x2
5	New hob injector Natural Gas	HOBINJECT185	x4
6	New hob injector LPG	HOBINJECT105	x4
7	New hob bypass screw Natural Gas	COPBPS-85NAT	x4
8	New Hob bypass screw LPG	COPBPS-50LPG	x4
9	New Pan Support	CASTP6BO	x2
10	New float rail	P4BORAIL	x1
11	New hob rear pipe	FLEXT250X8	x2
12	New hob front pipe	FLEXT500X8	x2
13	Control knob	ULTKNOB2	x4
14	Door handle	P6BOHANDLE	x1
15	Oven burner	P4BOBURNER	x1
16	New oven valve	OVENVALVE	x1
17	New oven thermocouple	THCP320ISP	x1
18	Thermocouple extension	THERMOCOUEXT	x1
19	Oven injector Natural Gas	INJECT150	x1
20	Oven injector LPG	INJECT99	x1
21	New oven bypass screw Natural Gas	COPBPS-60	x1
22	New oven bypass screw LPG	COPBPS-60	x1
23	Piezo spark generator	PIEZO1SP1	x1
24	Electrode	BRKETASSY	x1
25	H.T leads	CABLHT750	x1
26	Oven door catch	ADJROLLERCATCH	x2
27	Oven door catch plate	P4BODOORCATCH	x1
28	Oven door seal	SEALPGS10	x1
29	Adjustable castor braked	CASTRFIXD	x2
30	Adjustable castor unbraked	CASTB100	x2
31	Oven pipe	P4BOOVNPIPE	x1

To order spare parts please contact our spare partner First Choice on 01543 577778

**Parry Group Limited, Town End Road, Draycott, Derby, England DE72 3PT**  
**www.parry.co.uk**



**INSTRUCTION REF: IN166**

**ISSUE NO. 5**

**DATE - 05.08.14**

**Page 22 of 23**

**TELEPHONE: SERVICE (44) 01332 875665**  
**FAX: SERVICE (44) 01332 875536**

## **WARRANTY INFORMATION**

### **WARRANTY POLICY**

- The manufacturers warranty is only valid in the UK mainland & Northern Ireland, Western Isles, Inner Hebrides and Islands are parts only warranty.
- All service calls will be carried out between the hours of 8.00am – 5.00pm Monday to Friday only.
- We accept no responsibility for delays in replacing or repairing the equipment due to circumstances beyond our control.
- Your warranty can be immediately invalid if the installation of the equipment has not been installed in accordance with the manufactures instruction. (See installation details). Also the miss-use, alteration or unauthorised repairs of the equipment will invalidate the warranty.
- During the warranty period it is at Parrys discretion to repair or replace the equipment.
- Warranty only applies if the equipment has been used in a professional manor following the manufactures instructions and maintenance guide lines.
- The warranty covers defects in the material and components failure only we are not liable for trading loss, loss of perishable items, water damage, loss due to injury or fire damage.

### **WARRANTY REQUEST**

- Please ensure you have referred to the manufacturers' instruction before placing a warranty call. Or contact our warranty department on 01332 875665 for technical assistance. Please ensure you obtain the model number before calling.
- Please ensure you have read the section not covered under warranty to avoid any unnecessary warranty charges.
- If the problem with the machine can not be resolved please contact the company that supplied you the machine.

**(SERVICE CALLS CAN NOT BE PLACED DIRECT WITH PARRY)**

**Parry Group Limited, Town End Road, Draycott, Derby, England DE72 3PT**  
**[www.parry.co.uk](http://www.parry.co.uk)**



**INSTRUCTION REF: IN166**

**ISSUE NO. 5**

**DATE - 05.08.14**

**Page 23 of 23**

**TELEPHONE: SERVICE (44) 01332 875665**  
**FAX: SERVICE (44) 01332 875536**

**NOT COVERED UNDER WARRANTY**

- Fault due to poor maintenance.
- Resetting of equipment or circuit breakers.
- Abuse of the equipment
- Foil should never be used on racks
- Blockages eg, drains, condensers, pumps etc
- Lime scale related issues
- Installed incorrectly
- Access arranged for service call and engineer refused access or customer not there.
- No faults with the machine.
- Setting up of equipment eg, dishwasher detergents, levelling and setting up of doors on a 6 burner cooker.
- Excessive carbon build up on griddle plates.
- Over use of lava rock on the chargrills recommended use by Parry 2kg only.
- Faulty electrics – eg, customers plug socket, plug, wiring, junction box fault, wrong fuse.
- Any damages caused by the customer.
- Lamps, glass, door gaskets, Perspex, baskets, knobs all perishable items are not covered.

All of the above are not covered under our warranty policy. Any costs incurred because of the above will be forwarded to the parties responsible for placing the call.

Failure to pay any warranty charges will result in the customers warranty been put on hold until the bill has been settled.

Any issues regarding the raised charges should be put in writing to our warranty department for further investigation.