

**HOT GASTRO BUFFET  
INSTRUCTION MANUAL  
BZ-GB3-HOT, BZ-GB4-HOT, BZ-GB6-HOT**



## **CONTENTS**

1. AIMS AND SCOPE
2. RESPONSIBILITIES
3. SIGNS
4. TECHNICAL DATA (BASIC FEATURES)
5. TRANSPORTATION AND INSTALLATION
6. GENERAL PRINCIPLES
7. INFORMATIONS AND EQUIPMENTS RELATED TO PRODUCT
8. DESCRIPTION OF DEVICE WITH EXPLANATIONS
9. REPLACING THE DEVICE AND PREPARING FOR START UP  
INSTALLATION BEFORE ASSEMBLING  
PREPARATION FOR START UP  
FINAL CHECK BEFORE START UP
10. START UP
11. ELECTRICAL DIAGRAM
12. MAINTENANCE AND CLEANING  
DAILY MAINTENANCE AND CLEANING  
WEEKLY MAINTENANCE AND CLEANING
13. SAFE LIFE
14. INTERVENTION AFTER FAILURE
15. SPARE PARTS LIST

### 1. AIMS AND SCOPE





Descriptions for safe use and maintenance of the product

### 2. RESPONSIBILITIES

**Responsibilities of Product's Owner:** The product's owner is responsible for applying of safety rules stated in this Instruction Manual or getting them applied by delegating his authorities and risks, which may arise due to not applying. The product's owner is also responsible for the periodical maintenance of the machine.

**Responsibilities of the Manufacturers:** The manufacturer is responsible for the risks due to manufacturing and assembling faults, even though all requirements stated in this manual have been fulfilled.

### 3. SIGNS

	WARNING: This sign indicates that it must be complied with the instructions related to the subject; otherwise, the risky conditions, in which there can occur some damages and dangers
	CAUTION: This sign indicates any risky conditions, which can cause damages in material and injuring of people, provided that one does not pay attention and states that one must be careful.
	DANGER: This sign indicates high risky conditions in which people can be injured, provided that one does not pay attention and the rules always to be complied with.
	DANGER: This sign indicates high risky conditions in which the people can be injured or can die due to electrical shock.
	Equipotential connection terminal (If necessary, it must be connected to other equipment to make equal the potential)

#### 4. TECHNICAL DATA

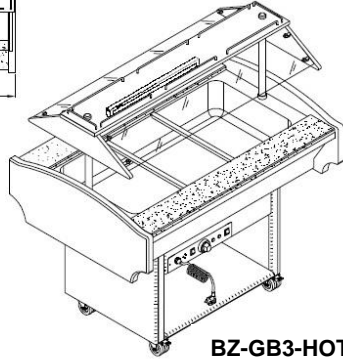
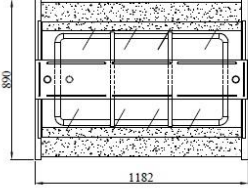
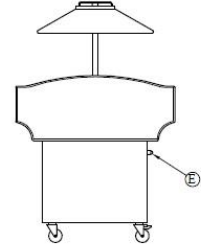
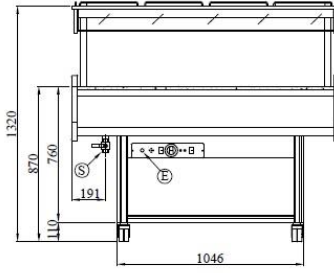
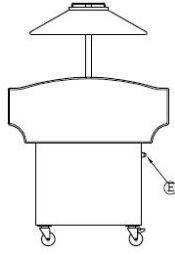
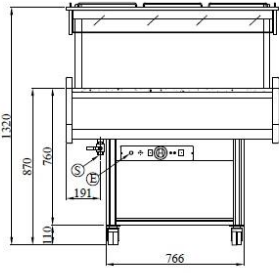

**BZ-GB3-HOT**

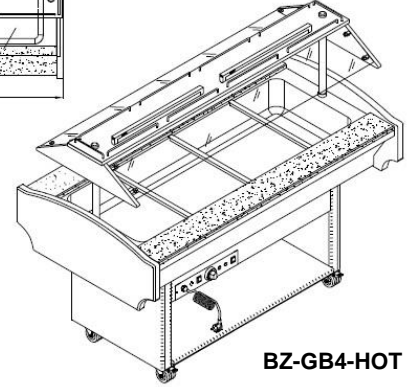
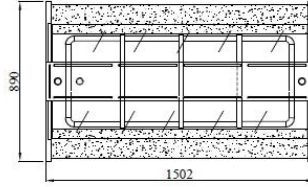

**BZ-GB4-HOT**

E-ELEKTRİK KABLO GİRİŞİ  
(POWER CABLE INLET)  
S-SU ÇIKIŞI (WATER OUTLET)

E-ELEKTRİK KABLO GİRİŞİ  
(POWER CABLE INLET)  
S-SU ÇIKIŞI (WATER OUTLET)

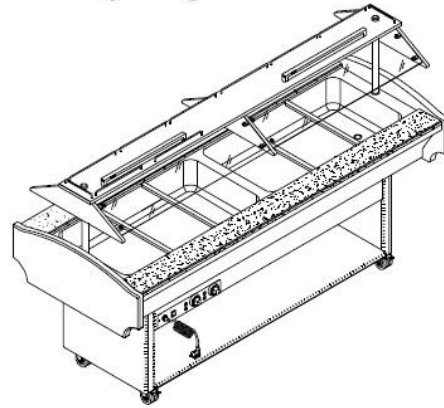
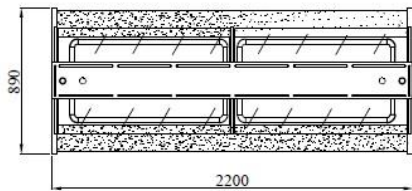
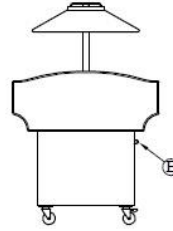
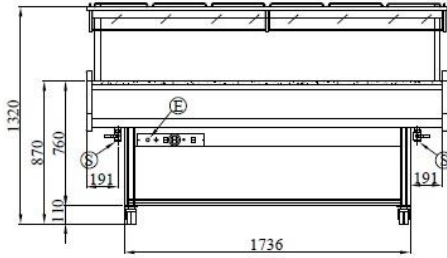





**BZ-GB6-HOT**















E-ELEKTRİK KABLO GİRİŞİ  
(POWER CABLE INLET)  
S-SU ÇIKIŞI (WATER OUTLET)

MODEL	DIMENSION (mm)	ENERGY	POWER (Kw)	POWER SUPPLY	CABLE (mm <sup>2</sup> )	GROSS kg	GROSS M3
BZ-GB3-HOT	1190x900x870/1320	ELECTRIC	2,013	220 - 230V 50Hz	3X1,5	143	1,60
BZ-GB4-HOT	1520x900x870/1320	ELECTRIC	3,026	220 - 230V 50Hz	3x1,5	172	2,03
BZ-GB6-HOT	2180x900x870x1320	ELECTRIC	4,026	220 - 230V 50Hz	3x2	246	2,97

## 5. TRANSPORTATION AND INSTALLATION

	During transportation, take necessary precautions against the risk of falling down and being turned upside down for the product.
	Place the product onto a flat and solid ground.
	Do not install the product near the flammable and explosive materials and do not keep any flammable and explosive material near the furnace, while it is working.
	Keep surely a fire extinguisher near the furnace and check whether the periodical checking of the fire extinguisher has been implemented or not.

## 6. GENERAL PRINCIPLES

-  Operation of electrical connection and service must be performed by a technical staff who had earlier necessary education about both first installation and maintenance
-  Disconnect Device is conducted by disconnecting the energy cackles from the energy source or switching off the main switch
-  It is deemed that the users have accepted to conform to the rules stated in instruction manuals and their products will be out of guarantee scope, unless they conform these rules.
-  The users are responsible for every sort of abstract and tangible cases, which can arise in case of not conforming to the rules stated instruction manual.
-  Do not put any living on the devices. Device must be used to the purpose.
-  The children and unauthorized people are not allowed to use the device.
-  All cleaning operations of the product must be done after switching off the electrical connections of the devices.
-  The product must not be operated in no ways without being completed a grounding installation which complies with the standards and are adequate, and without mounting LEAK CURRENT RELAY and fuse groups to the control panel supplying electrical energy
-  While the device is working, do not open in any way the cover of the device with cover.
-  Do not wash in no ways the electrical device by pouring water on them. Cleaning must be done by wiping the device, after switching off the energy.
-  During cleaning, do not use scratching and abrading means.
-  All safety checking has been performed. All tests have been implemented related to the product and the product is in active.
-  Use rubber gloves during cleaning and maintenance.
-  Do not remove the label of the devices and warning labels
-  Manufacturer firm is not responsible for the printing errors, which take place in the instruction manual and device description catalogue, coming together with the device.

- i** Manufacturer reserves the right to make changes related to the every kind of improvement, if it is necessary.
- i** The electric connection must be disconnected before changing the lamp
- i** Power cord must be min. H05RN-F type.
- i** Cable diameter must be min. : SHBM3/SHBM4 : 3X1,5 MM<sup>2</sup> ,SHBM6 : 3X2 MM<sup>2</sup>
- i** Grounding line must be continuously checked.
- i** Water Level : Max. Level : 2 points , Min Level : 1 points

## **7. INFORMATIONS AND EQUIPMENTS RELATED TO PRODUCT**

A. Description Catalogue

B. User/Maintenance/Assembling Manual

Dear Customers, please check the above written auxiliary equipment to be given with the machine on delivery. If you notice any damage or loss occurred during the transportation then you should request the transporter to issue any written report including the relevant damage or loss.

## **8. DESCRIPTION OF DEVICE WITH EXPLANATIONS**

The device have wholly manufactured regarding to hygienic standards.

Outside, inside and all surfaces contacting to the food of the device have been manufactured completely AISI 304 (Cr-Ni 18/10) stainless steel material.

The legs are in adjustable feature and manufactured by stainless steel material.

For the insulation purposes, glass- wool and stone-wool have been used. Thanks to this application, wasting of energy can be able to prevent.

Electrical operated devices have been secured completely by means of thermal and electrical relays.

Accesses to control panel, maintenance and checking have been facilitated.

Electrical components and cable are complied with the relevant standards.

## **9. REPLACING THE DEVICE AND PREPARING FOR START UP**

### **INSTALLATION BEFORE ASSEMBLING**

- i** Open the packing of the device and remove all protective tapes.
- i** Opening the cover of the device, take out the instruction manual.
- i** Place the devices with adjustable legs by adjusting their legs and the device with fixed legs by aligning the ground.
- i** Make the grounding connection thoroughly.
- i** Be sure that the energy supplied.
- i** Authorized and certificated people must make all these connection.
- i** Now, your device is ready for use.

### **PREPARATION FOR START UP**

- i** Assuming that electrical installation connections have already made by competent technicians, the user must implement the following simple inspections
- i** Be sure that in electrical operated devices, the electricity current has been supplied in adequate features as stated in TECHNICAL DATA catalogue and grounding connection has been complemented. .
- i** Read the instruction and maintenance manual absolutely.

### **FINAL CHECK BEFORE START UP**

- o The users should fulfill the following last-controls by accepting the required couplings of fresh water, electric, wastewater , installations to be carried out by the authorized technicians;
- o You must be sure that the power supply and grounding installation are ensured as required in leaflets of electrical equipment.
- o You must be sure that the feeding water has been installed and the water vane is turned on.
- o You must be sure that the wastewater installation was done properly and discharging hose was coupled with discharging pipe tightly.

## 10. START UP

**i** The figures of control panel on the devices have been shown. According to these figures, as earlier mentioned, the device, whose electrical connection was made fully and correctly, is operated by turning on control switches. (thermostat)

**i** "A" thermostat on the device, whose electrical connection was made, is brought into desired position.

**i** When the thermostat lamp lights off, it means that the heater has reached desired temperature

**i** While the devices are in operation, do not keep burning material (plastic bags, table napkin, clothe etc.) near them. Do not operate the device out of the liquid levels which are mentioned on the table

**i** After using the device, bring all control switches in to "0" position and switch off electric energy.

**i** While device is in operation, the device, heater, top side and front panels reach to high temperature. Do not touch these parts in no way.

### CONTROL PANEL

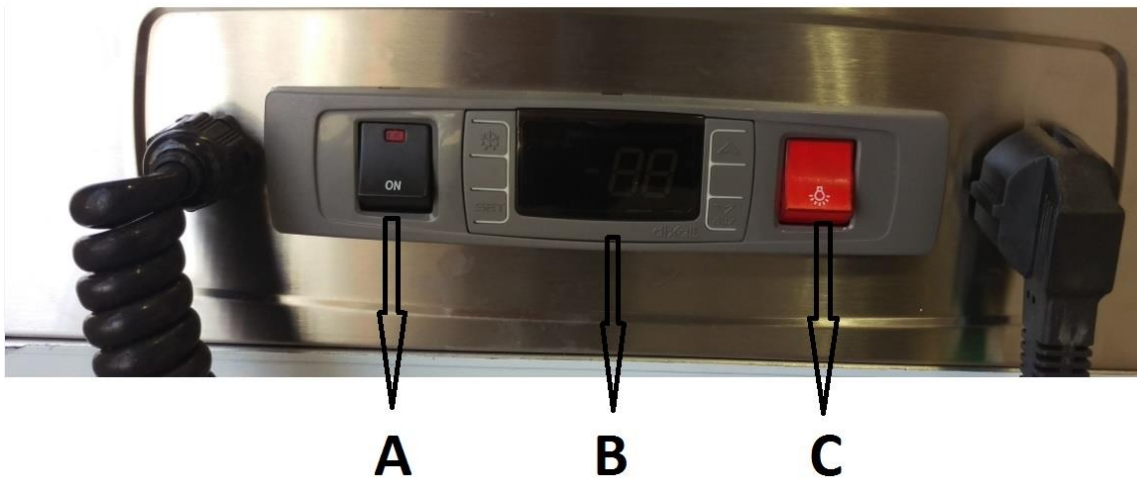

**A- ON/OFF SWITCH**

**B – DIGITAL THERMOMETER**

**C- LIGHTNING SWITCH**

## 11. MAINTANCE AND CLEANING

Implement the following periodical maintenance so that the product should work in safe and long life

### DAILY MAINTANCE AND CLEANING

- Device must be cleaned every day after use, after being sure that it is completely cooled down.
- Cleaning must be made by a clean wet cloth by wiping the device. It is recommended that stainless steel surfaces should be wiped by inox cleaners.

### WEEKLY MAINTANCE AND CLEANING

- During cleaning, do not use sharp edged, cutting and drilling tools such as scraper, emery in no way.
- Cleaning must not be done by spraying the water onto the device in no way.
- If the device is used together with another device side by side, both devices must be cleaned parting them from their jointed places without damaging the electrical connections.

## 12. SAFE LIFE

The safe life of the product is 5 years.

## 13. INTERVENTION AFTER FAILURE

### FAILURES / CAUSES

#### • There is no heating.

- 1) Be sure that the energy supplied to the device.
- 2) Be sure that 0-1 switch is in open position.
- 3) Be sure that thermostat is open.

## 14. SPARE PARTS LIST

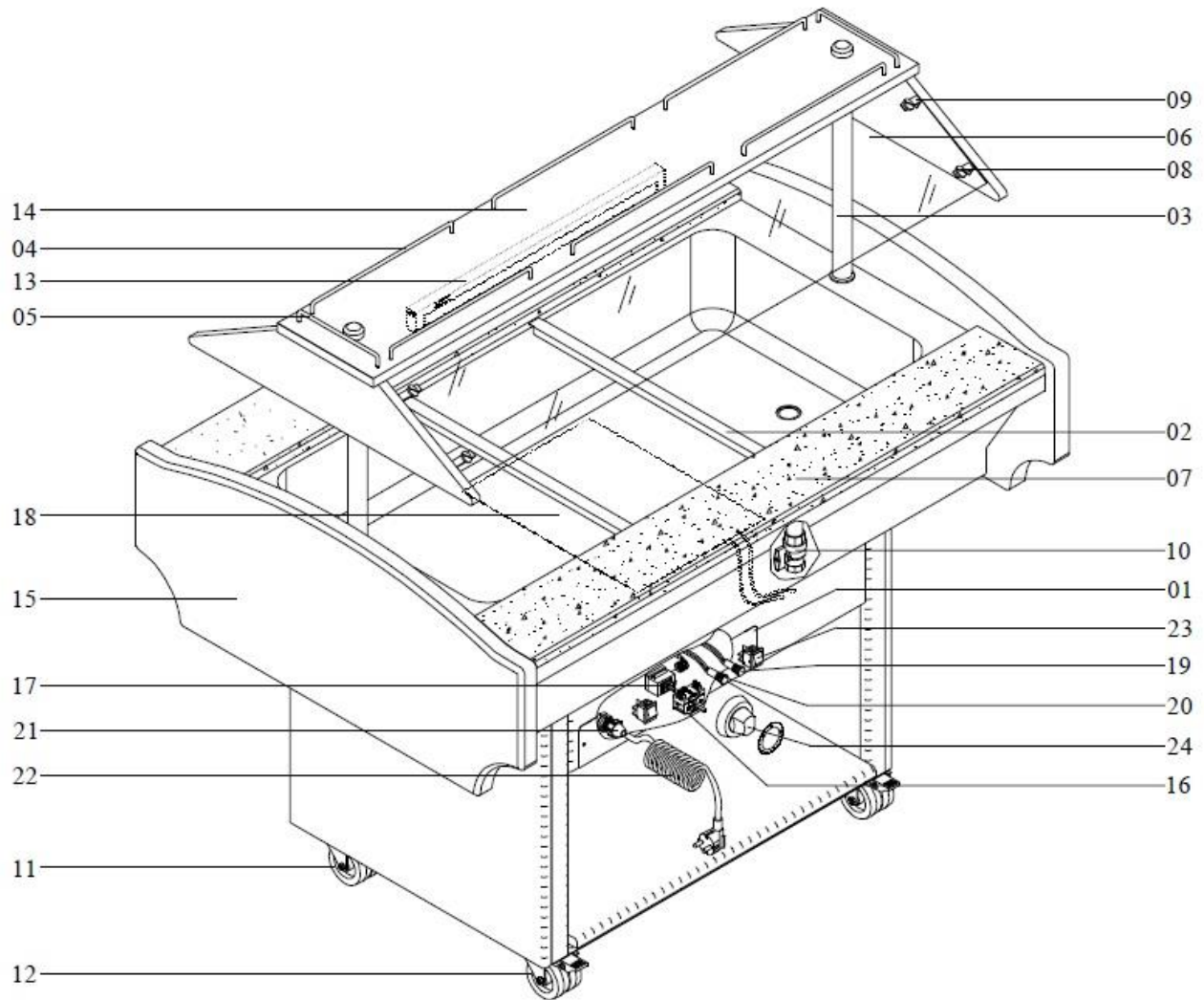

NO	DESCRIPTION	NO	DESCRIPTION
02	Strip	14	Stand
03	Foot	15	Wooden Panel
04	Railing	16	Breaker
05	Railing	17	Thermostat
06	Glass	18	Heating Element
07	Granite	19	Signal Lamp
08	Bolt & Nut	20	Signal Lamp
09	Coupling Piece	21	Fitting
10	Butterfly Valve	22	Cable
11	Castor	23	On/Off Switch
12	Castor (w/ Brake)	24	Knob
13	Armature		



