



Microwave Oven

INSTRUCTION MANUAL

Model: BCM1800

Read these instructions carefully before using your microwave oven, and keep it carefully.

If you follow the instructions, your oven will provide you with many years of good service.

SAVE THESE INSTRUCTIONS CAREFULLY

PRECAUTIONS TO AVOID POSSIBLE EXPOSURE TO EXCESSIVE MICROWAVE ENERGY

- (a) Do not attempt to operate this oven with the door open since this can result in harmful exposure to microwave energy. It is important not to break or tamper with the safety interlocks.
- (b) Do not place any object between the oven front face and the door or allow soil or cleaner residue to accumulate on sealing surfaces.
- (c) **WARNING:** If the door or door seals are damaged, the oven must not be operated until it has been repaired by a competent person.

ADDENDUM

If the apparatus is not maintained in a good state of cleanliness, its surface could be degraded and affect the warranty and lifespan of the apparatus and lead to a dangerous situation.

Specifications

Model:	BCM1800
Rated Voltage:	230V~50Hz
Rated Input Power(Microwave):	3000W
Rated Output Power(Microwave):	1800W
Oven Capacity:	34L
External Dimensions:	574 x 528 x 368 mm
Net Weight:	Approx. 32.2kg

IMPORTANT SAFETY INSTRUCTIONS

WARNING

To reduce the risk of fire, electric shock, injury to persons or exposure to excessive microwave oven energy when using your appliance, follow basic precautions, including the following:

1. Warning: Liquids and other foods must not be heated in sealed containers since they are liable to explode.
2. Warning: It is hazardous for anyone other than a competent person to carry out any service or repair operation that involves the removal of a cover which gives protection against exposure to microwave energy.
3. Warning: Only allow children to use the oven without supervision when adequate instructions have been given so that the child is able to use the oven in a safe way and understand the hazards of improper use.
4. Warning: When the appliance is operated in the combination mode, children should only use the oven under adult supervision due to the temperatures generated. (only for grill series)
5. Only use utensils suitable for use in microwave ovens.
6. The oven should be cleaned regularly and any food deposits should be removed.
7. Read and follow the specific: "PRECAUTIONS TO AVOID POSSIBLE EXPOSURE TO EXCESSIVE MICROWAVE ENERGY".
8. When heating food in plastic or paper containers, keep an eye on the oven due to the possibility of ignition.
9. If smoke is observed, switch off or unplug the appliance and keep the door closed in order to stifle any flames.
10. Do not overcook food.
11. Do not use the oven cavity for storage purposes. Do not store items, such as bread, cookies, etc. inside the oven.
12. Remove wire twist-ties and metal handles from paper or plastic containers/bags before placing them in the oven.
13. Install or locate this oven only in accordance with the installation instructions provided.
14. Eggs in the shell and whole hard-boiled eggs should not be heated in microwave ovens since they may explode, even after microwave heating has ended.
15. Use this appliance only for its intended uses as described in manual. Do not use corrosive chemicals or vapors in this appliance. This oven is especially designed to heat. It is not designed for industrial or laboratory use.
16. If the supply cord is damaged, it must be replaced by the manufacturer, its service agent or similarly qualified persons in order to avoid a hazard.
17. Do not store or use this appliance outdoors.
18. Do not use this oven near water, in a wet basement or near a swimming pool.
19. The temperature of accessible surfaces may be high when the appliance is operating. The surfaces are liable to get hot during use. Keep cord away from heated surface, and do not cover any vents on the oven.
20. Do not let cord hang over edge of table or counter.
21. Failure to maintain the oven in a clean condition could lead to deterioration of the surface that could adversely affect the life of the appliance and possibly result in a hazardous situation.
22. Warning: The contents of feeding bottles and baby food jars shall be stirred or shaken and the temperature checked before consumption, in order to avoid burns.
23. Warning: Microwave heating of beverages can result in delayed eruptive boiling, therefore care must be taken when handling the container.
24. The appliance is not intended for use by persons (including children) with reduced physical, sensory or mental capabilities, or lack of experience and knowledge, unless they have been given supervision or instruction concerning use of the appliance by a person responsible for their safety.
25. Children should be supervised to ensure that they do not play with the appliance.

26. The microwave oven shall not be placed in a cabinet unless it has been tested in a cabinet.

27. Appliances are not intended to be operated by means of an external timer or separate remote-control system.

28. The door or the outer surface may get hot when the appliance is operating.

29. The means for disconnection from the supply mains having a contact separation in all poles that provide full disconnection under overvoltage category III conditions must be incorporated in the fixed wiring in accordance with the wiring rules.

To Reduce the Risk of Injury to Persons Grounding Installation

DANGER

Electric Shock Hazard

Touching some of the internal components can cause serious personal injury or death. Do not disassemble this appliance.

This appliance must be grounded. In the event of an electrical short circuit, grounding reduces the risk of electric shock by providing an escape wire for the electric current. This appliance is equipped with a cord having a grounding wire with a grounding plug. The plug must be plugged into an outlet that is properly installed and grounded.

WARNING

Electric Shock Hazard

Improper use of the grounding can result in electric shock. Do not plug into an outlet until appliance is properly installed and grounded.

Consult a qualified electrician or serviceman if the grounding instructions are not completely understood or if doubt exists as to whether the appliance is properly grounded. If it is necessary to use an extension cord, use only a 3-wire extension cord.

CLEANING

Be sure to unplug the

appliance from the power supply.

1. Clean the inside of the oven after using with a slightly damp cloth.
2. Clean the accessories in the usual way in soapy water.
3. The door frame and seal and neighboring parts must be cleaned carefully with a damp cloth when they are dirty.

1. A short power-supply cord is provided to reduce the risks resulting from becoming entangled in or tripping over a longer cord.
2. If a long cord set or extension cord is used:
 - 1) The marked electrical rating of the cord set or extension cord should be at least as great as the electrical rating of the appliance.
 - 2) The extension cord must be a grounding-type 3-wire cord.
 - 3) The long cord should be arranged so that it will not drape over the counter top or tabletop where it can be pulled on by children or tripped over unintentionally.

CAUTION

Personal Injury Hazard

It is hazardous for anyone other than a competent person to carry out any service or repair operation that involves the removal of a cover which gives protection against exposure to microwave energy.

UTENSILS

See the instructions on "Materials you can use in microwave oven or to be avoided in microwave oven." There may be certain non-metallic utensils that are not safe to use for microwaving. If in doubt, you can test the utensil in question following the procedure below.

Utensil Test:

1. Fill a microwave-safe container with 1 cup of cold water (250ml) along with the utensil in question.
2. Cook on maximum power for 1 minute.
3. Carefully feel the utensil. If the empty utensil is warm, do not use it for microwave cooking.
4. Do not exceed 1 minute cooking time.

Materials you can use in microwave oven

Utensils	Remarks
Browning dish	Follow manufacturer's instructions. The bottom of browning dish must be placed smoothly on the ceramic board. Incorrect usage may cause the ceramic board to break.
Dinnerware	Microwave-safe only. Follow manufacturer's instructions. Do not use cracked or chipped dishes.
Glass jars	Always remove lid. Use only to heat food until just warm. Most glass jars are not heat resistant and may break.
Glassware	Heat-resistant oven glassware only. Make sure there is no metallic trim. Do not use cracked or chipped dishes.
Oven cooking bags	Follow manufacturer's instructions. Do not close with metal tie. Make slits to allow steam to escape.
Paper plates and cups	Use for short-term cooking/warming only. Do not leave oven unattended while cooking.
Paper towels	Use to cover food for reheating and absorbing fat. Use with supervision for a short-term cooking only.
Parchment paper	Use as a cover to prevent splattering or a wrap for steaming.
Plastic	Microwave-safe only. Follow the manufacturer's instructions. Should be labeled "Microwave Safe". Some plastic containers soften, as the food inside gets hot. "Boiling bags" and tightly closed plastic bags should be slit, pierced or vented as directed by package.
Plastic wrap	Microwave-safe only. Use to cover food during cooking to retain moisture. Do not allow plastic wrap to touch food.
Thermometers	Microwave-safe only (meat and candy thermometers).
Wax paper	Use as a cover to prevent splattering and retain moisture.

Materials to be avoided in microwave oven

Utensils	Remarks
Aluminum tray	May cause arcing. Transfer food into microwave-safe dish.
Food carton with metal handle	May cause arcing. Transfer food into microwave-safe dish.
Metal or metal-trimmed utensils	Metal shields the food from microwave energy. Metal trim may cause arcing.
Metal twist ties	May cause arcing and could cause a fire in the oven.
Paper bags	May cause a fire in the oven.
Plastic foam	Plastic foam may melt or contaminate the liquid inside when exposed to high temperature.
Wood	Wood will dry out when used in the microwave oven and may split or crack.

SETTING UP YOUR OVEN

Names of Oven Parts and Accessories

Remove the oven and all materials from the carton and oven cavity.

Your oven comes with the following parts and accessories:

Instruction Manual

1

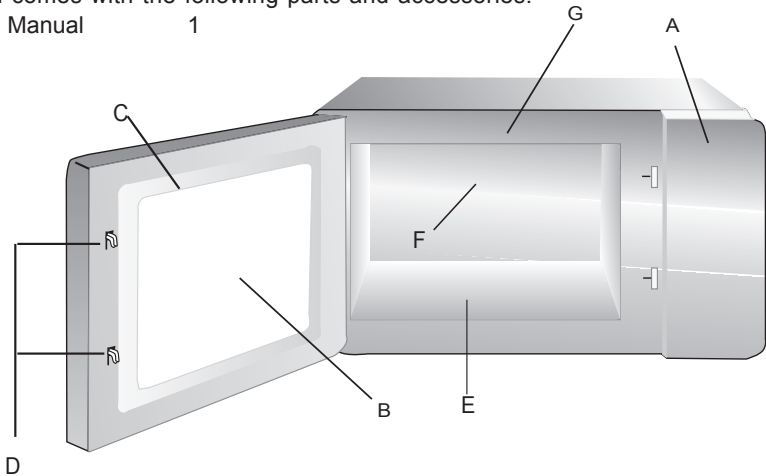

A) Control panel

B) Observation window

C) Door assembly

D) Safety interlock system

E) Ceramic board

F) Back plate

G) Front plate

Note: 1) Don't press the ceramic board forcibly.

2) Take and put the utensils gently during the operation in order to avoid damage to the ceramic board.

3) After using, don't touch the ceramic board by hand in order to avoid high temperature scald.

Countertop Installation

Remove all packing material and accessories. Examine the oven for any damage such as dents or broken door. Do not install if oven is damaged.

Cabinet: Remove any protective film found on the microwave oven cabinet surface.

Installation

1. Select a level surface that provide enough open space for the intake and/or outlet vents(Figure1).

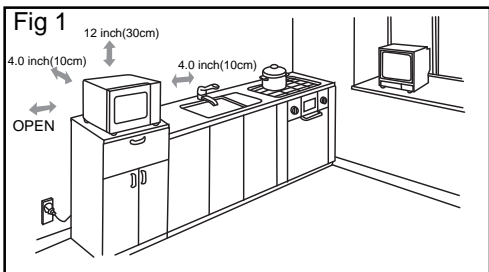

A 10-cm spacing should be kept between the appliance and right and back walls, and a 30-cm spacing kept on the top. Never dismantle the appliance's feet, nor block the air intake and exhaust opening. The left side must be open.

- 1) Blocking the intake and/or outlet openings can damage the oven.
- 2) Place the oven as far away from radios and TV as possible. Operation of microwave oven may cause interference to your radio or TV reception.
- 3) Plug your oven into a standard household outlet. Be sure the voltage and the frequency is the same as the voltage and the frequency on the rating label.
- 4) Warning: The plug socket, electric appliances or the appliance which are liable effected by heat and moisture should be kept away from any vents on the oven.

Cleaning Instructions

Always keep the oven clean

1. Cleaning the glass viewing window, the inner door panel and oven front face.

For best performance and to maintain the high degree of safety, the inner door panel and oven front face should be free of food or grease build-up. Wipe these parts with a mild detergent, rinse and wipe dry. Never use abrasive powders or pads.

2. Cleaning the control panel and plastic parts.

Do not apply a detergent or an alkaline liquid spray to the control panel and plastic parts, as this may cause damage to these parts.

Use a dry cloth (not a soaked cloth) to clean these parts.

3. Cleaning the oven interior

After use be sure to clean up spilled liquids, spattered oil and food debris as quickly as possible. If the oven is used when dirty, efficiency drops and the dirt gets stuck on the oven surface and may cause bad odours. Clean the interior with a cloth soaked in luke-warm water with a mild detergent dissolved in it, then rinse the soap off with a damp cloth.

4. Clean the stirrer cover regularly ensuring all debris is removed (see page 19 for removal and installation instructions).

5. Cleaning the filter regularly, keep it clear .The appliance will over heat when the filter is blocked (see page 18 for removal and installation instructions).

6. When the appliance is operated, stirrer cover and filter location must correct, avoiding to damage other parts (the installation in page 18 and 19).

CAUTION: Do Not wipe plastic and painted sections of the oven with bleach, thinners or other cleaning agents, as this may cause these parts to dissolve or change shape.

OPERATION

Control Panel and Features

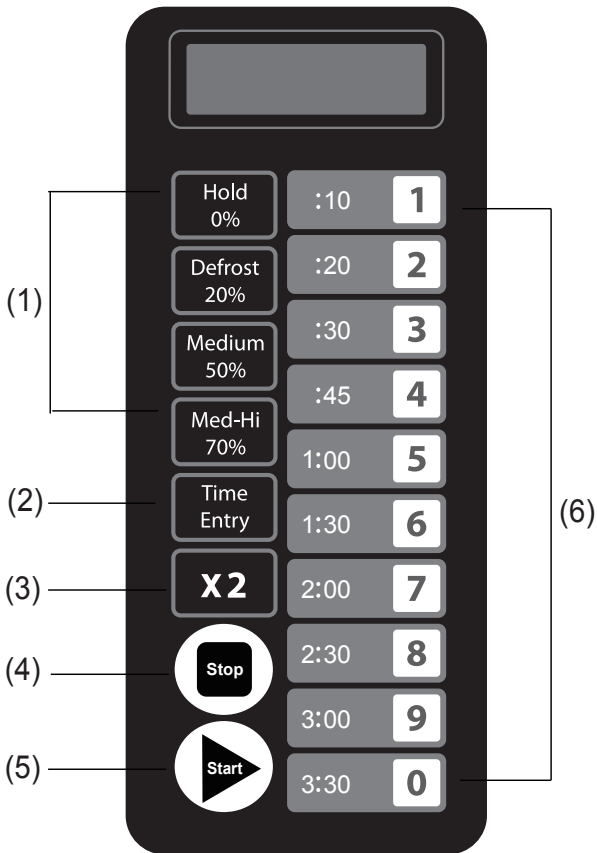

- (1) Power Buttons
- (2) Time Entry Button
- (3) Double Quantity Button
- (4) Stop/Reset Button
- (5) Start Button
- (6) Number Keyboard

OPERATION INSTRUCTION

Appendix. A User Options

Items bolded below are the default values.

Option	Setting	Discription
1 EOC Tone	OP:10	3 seconds beep
	OP:11	Continuous beep
	OP:12	5 quick beeps,Repeating
2 Beeper Volume	OP:20	Beeper Off
	OP:21	Low
	OP:22	Medium
3 Beeper On/Off	OP:23	High
	OP:30	Keybeep Off
4 Keyboard Window	OP:31	Keybeep On
	OP:40	15 seconds
	OP:41	30 seconds
	OP:42	60 seconds
5 On the Fly	OP:43	120 seconds
	OP:50	On-the-Fly Disable
6 Door Reset	OP:51	On-the-Fly Enable
	OP:60	Door reset Disable
7 Max time	OP:61	Door Reset Enable
	OP:70	60 Minute Maximum Cook Time
8 Manual Programming	OP:71	10 Minute Maximum Cook Time
	OP:80	Manual Programming Disable
9 Double Digit	OP:81	Manual Programming Enable
	OP:90	Single Digit Mode-10 programs
	OP:91	Doule Digit Mode-100 programs

Appendix. B Default Cook Times

The oven shall ship with the following Preset Cook Times unless otherwise noted in the product Specification.

Button	Display (Time)	Power	Cook Factors
1	0:10	100%	80%
2	0:20	100%	80%
3	0:30	100%	80%
4	0:45	100%	80%
5	1:00	100%	80%
6	1:30	100%	80%
7	2:00	100%	80%
8	2:30	100%	80%
9	3:00	100%	80%
0	3:30	100%	80%

1. Power Up

" ----- " displays when the oven is electrified for the first time. If "  " button pressed, the oven will change to idle mode.

For some model:

2. Idle Mode

- 1) Entry. The oven shall enter idle mode after a set of seconds have expired in Ready Mode without a keyboard press or a door open and close. The number of seconds is determined by the keyboard Timeout Window, set by User Option 4.
- 2) During idle mode, the screen is blank. And there shall be no oven activity.
- 3) Opening and then closing the oven door, the oven will exit the idle mode and into ready mode.



3. Ready Mode

- 1) In this mode, the oven is ready to either begin a manual or preset cook cycle.
- 2) Opening and closing the door while the oven is in Idle Mode will put the oven into Ready Mode.
- 2) During Ready Mode, "READY" displays.
- 3) From the Ready Mode, the oven can go to almost all of the other modes.



4. Door Open Mode

- 1) While the door of the oven is open, the oven shall be in Door Open Mode.
- 2) During this mode, the screen is blank. And the fan and oven lamp work.
- 3) When the door is closed, if User Option OP:60 is selected and the oven was running a manual or preset cook cycle, the oven shall enter Pause Mode. In all other cases, the oven shall return to Door open Mode with User Option OP:61 set, opening and closing the door will clear out any information about a Manual or Preset Program which was running.



5. Pause Mode

- 1) This mode allow the users to temporarily stop the cooking cycle to inspect or stir the food item.
- 2) While in Manual Cook Mode, or Preset Program Cook Mode, if the door is open or closed, or if the "  " pad is pressed, the oven will enter Pause Mode.
- 3) While paused, the screen will display the remaining cooking time.
- 4) Pause Mode will expire back to Idle Mode in the exact fashion as Ready Mode, dependent on User Option 4. Additionally,if the "  " button is pressed, the oven shall immediately enter Ready Mode.OR if press "  " button, the oven will go into working mode.

6. Manual Cook Entry Mode

- 1) The user may manually enter a cook time and power level while in this mode.
- 2) While the oven is in the Ready Mode,pressing the "Time Entry" pad on the keyboard will put the oven into Manual Cook Entry Mode.
- 3) During this mode, "00:00" displays,input the time you need.
- 4) If you press "Hold 0% "," Defrost 20%","Medium 50%" or "Med-Hi 70%" button to select power level, the screen will display the related power. If the same button pressed twice, the power will change to PL10. If no power chosen, "PL10" is default.
- 5) During setting process, press "  " to enter Manual Cook Mode.
Press "  " to enter Ready Mode.

7. Manual Cook Mode

- 1) This mode allows cooking of the food items.While in Manual Cook Entry Mode, pressing the "  " pad will cause to the oven to begin Manual Cook Mode.
- 2) During this mode, remaning cooking time displays. The fan and oven lamp will light.
- 3) When cooking program finish, the oven will enter End of Cook Cycle Mode.
If you press "  " button under this mode,the oven will enter Pause Mode.

8. End of Cook Cycle Mode

- 1) After the time has expired in a Manual Cook Mode, or a Preset Program Cook Mode, the oven shall go into The End of Cook Cycle Mode.
- 2) During this mode, "DONE" displays.
- 3) If either User Option OP:11 or "OP:12" is selected, the oven shall continue to sound until the user acknowledges this by either opening and closing the door or pressing the "II" pad. If User Option OP:10 is selected, after the 3 second beep, the oven shall go into Ready Mode.

9. Preset Program Cook Mode

- 1) This mode allows cooking of food items through a one pad touch operation. While in Ready Mode, pressing one of ten digit keys on the keyboard will cause the oven to run the Preset Program associated with that key.
- 2) During this mode, the screen displays the remaining cooking time. If it is multi-stage cooking, the total remaining cooking time displays not a particular stage cooking time.
- 3) When cooking program finish, the oven will enter End of Cook Cycle Mode. If you press " II " button under this mode, the oven will enter Pause Mode.

10. On the Fly Cooking

- 1) While the oven is cooking, if User Option OP:51 is selected, press number buttons, the preset cooking program will start automatically.
- 2) The screen displays the remaining cooking time.
- 3) When cooking program finish, the oven will enter End of Cook Cycle Mode.

11. Programming Mode

This mode allows the user to assign cook times and power levels to the once touche button.

- 1) Open the door and press "1" pad for 5 seconds,the buzzer will sound once and enter to Programming Mode.
- 2) "PROGRAM" displays. you can input the time you need.
- 3) Press "Hold 0% ", "Defrost 20%","Medium 50%" or "Med-Hi 70%" to input the power level. the screen will display the related power. If the same button pressed twice, the power will change to PL10. If no power chosen, "PL10" is default.

Note: Set the time first,then choose the power.

- 4) To change the cooking fators: If press "X2",the screen will display "CF:XX". The default factor is 80%. "CF:08" displays. If you need to change the cooking factor, just press one of the number buttons to set.

- 5) After setting the time and power, press "  ", the cooking program will be saved. When the program saved, "PROGRAM" displays.

- 6) If all the cooking time exceeds the MAX.time User Option 7, when press "  " to save the program, the buzzer will sound three times briefly to tell you the time is no use. And then the screen turn back to display "PROGRAM". The time set before will be no change.

- 7) Close the door, the oven will turn back to Ready Mode.

If press "  " button during setting process, the oven turn to Door Open Mode.

The program that not saved will be lost. If there is program saved as memory procedure, press the related number button, the saved program will start. If no saved program, the buzzer will alarm when pressing number button and it will not work.

For example: set the program as memory cooking. Power level PL7 and cooking time is 1 minute and 25 seconds.

Step1: Open the door, press number button "1" for 5 seconds,"PROGRAM" displays.

Step 2: Press number button "3", the screen will display "P:03",After two seconds, the screen will display the related time " :30".

Step 3: Press number buttons "1", "2" and "5" to input the cooking time.

Step 4: Press "Med-Hi/70% " button," 1:25 70" displays. Setting finished.

Step 5: Press "  " to save. When use the program next time, just press "3", the related program will start.

Note:

1. If the electricity is cut off, the saved program will not lost.
2. If the program need to reset , just repeat the aboved steps.
3. If press "  " at the last step, it will turn back to Ready Mode. The setting will be no use.

12. Double Quantity cooking

- 1) Through the use of the X2 pad, the user can easily set the time two of a particular food item.
- 2) If the "X2" button is pressed in ready mode, followed by the starting of a Preset Program, or if the "X2" button is pressed in 5 seconds of starting a Preset Program, the oven will start cooking with the quantity preset cooking time.
- 3) Press "X2", "DOUBLE" displays. When press number buttons, the screen will display the quantity preset time.
For example, number button "5" and its preset time is 1 minute. Then press "X2", then time will change to $1:00 \times (1+0.8) = 1:48$ (1 minute and 48 seconds)
- 4) When cooking program finish, the oven will enter End of Cook Cycle Mode.

Note: This function can be used under preset programme mode.

13. Stage Cooking Programming

This allows the user to cook food items at manual cook mode and programming mode.

- 1) Three stages can be set at most under cooking mode or programming mode.
After setting the power and time for the first stage, press "Time Entry" to set the second stage.
And the same step to set the third stage.
- 2) When setting the second, third stage, press "Time Entry", "STAGE-2", "STAGE-3" displays.
- 3) Press "  " button to start cooking.

Example: In programming mode, press number buttons "3" to set two stages cooking. The first stage is PL7 and time is 1 minute 25 seconds. The second stage is PL5 and 5 minutes and 40 seconds. The steps are follow.

- a. Open the door, press number button "1" for 5 seconds, "PROGRAM" displays.
- b. Press number button "3", the screen will display "P:03", After two seconds, the screen will display the related time " :30".
- c. Press "1", "2", "5" to input the cooking time. "1:25" displays.
- d. Press "Med-Hi 70%", "1:25 70" displays.

The first stage is finished.



- e. Press "Time Entry", "STAGE-2" displays.
- f. Press "5", "4", "0" button, "5:40" displays.
- g. Press "Medium 50%", "5:40 50" displays.

The second stage is finished.

- h. Press "  " button to start cooking.
- i. The total time counts down.

14. Use Option Mode

This allows the user choose between various ways for the oven to operate.





- 1) Open the oven door and press "2" pad for 5 seconds. The buzzer sounds once and enter this mode.
- 2) The screen displays "OP: - -".
- 3) Press any number button to enter related mode setting.
For example: to set the voice of the buzzer to medium. Press " 2 ", "OP:22" displays.
If you want to change, keep pressing "2", the screen displays "OP:20", "OP:21", "OP:22", "OP:23", "OP:20"in cycle.
- 4) Press "  " to save the current setting. After saved, "OP: - -" display again.
- 5) During setting process, press "  " to enter Door Open Mode. Close the door will enter Ready Mode.
- 6) If "  " button not pressed at the last step, the program cannot be saved but stay at previous way.

15. Service Mode

- 1) Open the oven door and press "3" pad for 5 seconds to enter service mode.
- 2) The screen displays "SERVICE".
- 3) To check the times of closing or opening the door, just press number button "3", the screen will display the times.
- 4) If press " 1 " pad for Tube Hours.
If press " 2 " pad for Tube Cycles.
If press " 3 " pad for Door Cycles..
If press " 4 " pad to Clear service information.
Only for some medels:
If press " 5 " pad to run Top Mag. Oven displays amps.
If press " 6 " pad to run Bottom Mag. Oven displays amps.
- 5) Press "  " to enter Door Open Mode. Close the door will enter Ready Mode.

16. Factory-default setting

In the Ready Mode,pressing "  " and " 0 " to factory-default setting.

- 1) Press "  " and " 0 ", the buzzer sounds once,and the screen will display "CHECK: If it is in the factory-default setting,the screen will display 11 ,after three seconds, the oven turn to the ready mode Press"  ".to cancel the display ang back to ready back in the process of display. If not in the factory-default setting,the screen will display " 00 ", press"  " to the factory-default setting, the screen will display " CLEAR ". the buzzer sounds once, after self-testing, the screen will display "11" or"00".
- 2) If do not press "  " when the screen display " 00 ",the setting will cancel.

Note: Be careful in the operation as it will restore all configure to factort-default setting.

How to remove and install the filter

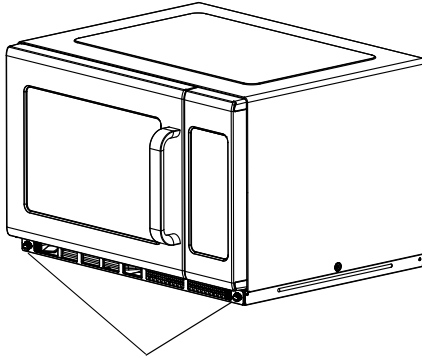

Turn the metal nails left to loosen them.

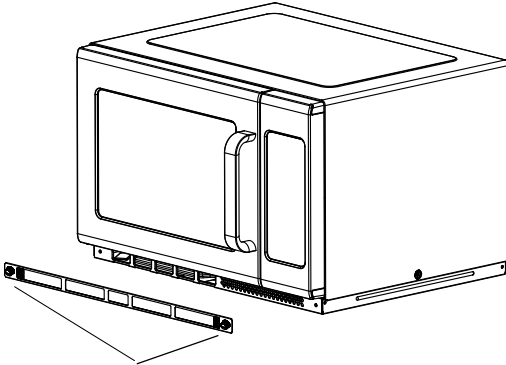

Take off the filter.

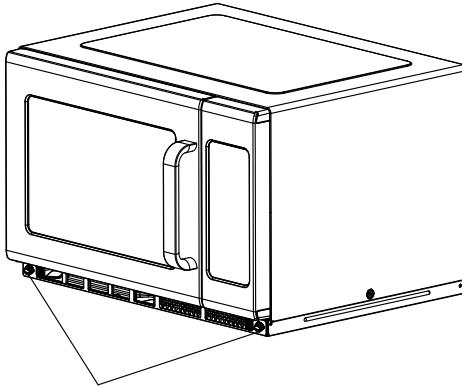

To restall,align the base plate mounting holes,
clockwise the metal nails to tighten .

How to remove and install the stirrer cover.



Warning: Before remove and install the stirrer cover, be sure to unplug the appliance from the power supply, and avoid high temperature scald.

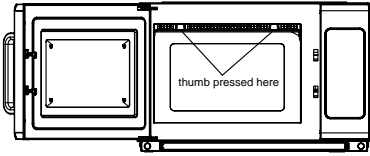

1 hands with oil blockage ,pressed on the arrow shown,pushed back slamly, then pulling down.

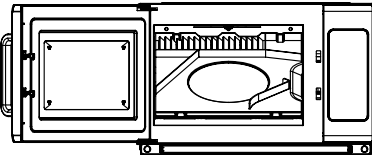

2.status of remove

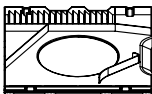
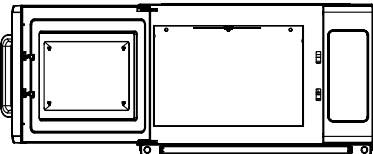

3.taking oil blockage from the appliance.

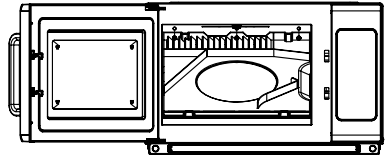

1.Hands to take the oil blockage,after alignment three cylinder of the oil blockage, inserting the three holes of the back plate.

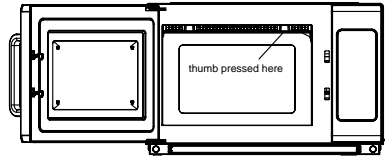

2.The left hand grasp the microwave, right thumb to press the arrow directions and forced to push back. And the left thumb hard pressed upward at the same time. put the right of oil blockage into the buckle of the front plate.

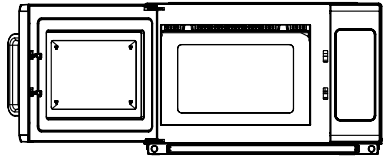

3.From right to left, make the oil blockage loaded. When finish, check to ensure that the oil blockage buckle completely go.

Trouble shooting

Normal	
Microwave oven interfering TV reception	Radio and TV reception may be interfered when microwave oven operating. It is similar to the interference of small electrical appliances, like mixer, vacuum cleaner, and electric fan. It is normal.
Dim oven light	In low power microwave cooking, oven light may become dim. It is normal.
Steam accumulating on door, hot air out of vents	In cooking, steam may come out of food. Most will get out from vents. But some may accumulate on cool place like oven door. It is normal.
Oven started accidentally with no food in.	It is forbidden to run the unit without any food inside. It is very dangerous.

Trouble	Possible Cause	Remedy
Oven can not be started.	(1) Power cord not plugged in tightly.	Unplug. Then plug again after 10 seconds.
	(2) Fuse blowing or circuit breaker works.	Replace fuse or reset circuit breaker (repaired by professional personnel of our company)
	(3) Trouble with outlet.	Test outlet with other electrical appliances.
Oven does not heat.	(4) Door not closed well.	Close door well.
Lamp light, fan make noise when the oven finish working.	Lamp light, fan still operate when the oven finish working.	It is normal. Lamp and fan stop work when the temperature goes down in the oven.



According to Waste of Electrical and Electronic Equipment (WEEE) directive, WEEE should be separately collected and treated. If at any time in future you need to dispose of this product please do NOT dispose of this product with household waste. Please send this product to WEEE collecting points where available.

Installation (supplement)

1. The switching operation of this microwave oven can cause voltage fluctuations on the supply line. The operation of this oven under unfavorable voltage supply conditions can have adverse effects. This device is intended for the connection to a power supply system with a maximum permissible system impedance Z_{max} of **0.2 Ohms** at the interface point of the user's supply. The user has to ensure that this device is connected only to a power supply system which fulfills the requirement above. If necessary, the user can ask the public power supply company for the system impedance at the interface point.
2. If there is no equipotential bonding conductor in the electric supply, an external equipotential bonding conductor must be installed at the rear of the appliance (see symbol). This terminal shall be in effective electrical contact with all fixed exposed metal parts and shall allow the connection of a conductor having a nominal cross-sectional area up to 10 mm².



Symbol for the external connection of equipotential bonding conductors.

PN:1617000A11645

