

WAREWASHING



Hood-type dishwashers

PREMAX AUP

AUP-10A
AUPS-10A
AUP-90A
AUPT-10A
AUPL-10A
AUPLS-10A

DSN: AMX-14-01
From SN: 86 60 30001

Installation and Operation Instructions

*(Translation of the original operating
instructions)*

EN

6. Jun. 2014

Publisher

HOBART GmbH
Robert-Bosch-Str. 17
77656 Offenburg
Tel. +49(0)781 600 0
Fax +49(0)781 600 23 19
E-mail: info@hobart.de
Internet: www.hobart.de

Product disclaimer

Installations and repairs carried out by non-authorized technicians or using non-genuine spare parts, and any technical alterations to the machine not approved by the manufacturer will invalidate the manufacturer's warranty and product liability.

HOBART reserves the right to make changes or improvements to its products without prior notice.

© HOBART GmbH, Offenburg 2014

Table of Contents

1	Notes on the documentation	5
1.1	Application	5
1.2	Layout of the documentation	5
1.3	Representation convention	5
2	Safety instructions and regulations	7
2.1	Safety instructions and warning notices	7
2.2	Basic safety instructions	7
2.3	Property damage	10
3	Product description	11
3.1	Intended purpose	11
3.2	Conformity	11
3.3	Designation	11
3.4	Technical specifications	11
4	Controls	13
4.1	Controls	13
4.2	Operating states	14
4.3	Display of faults and information	14
4.4	Display function	15
4.5	Overview of main menus	15
4.6	Overview of display symbols	16
5	Installation	18
5.1	Personnel qualification	18
5.2	Special safety instructions	18
5.3	Transporting to the installation location	19
5.4	Removing the packaging	19
5.5	Installing the machine	19
5.6	Connecting to the power supply	20
5.7	Connecting the water	21
5.8	Connect steam (optional)	22
5.9	Connecting the drain	22
5.10	Connecting the dispenser	23
5.11	Install the automatic soil removal unit	24
6	Commissioning	25
6.1	Personnel qualification	25
6.2	Special safety instructions	25
6.3	Starting the commissioning procedure	25
6.4	Setting the language	25

Table of Contents

6.5	Setting the date	25
6.6	Setting the time	26
6.7	Setting the water hardness (optional)	26
6.8	Filling the salt reservoir (optional)	26
6.9	Filling chemical hoses	27
6.10	Completing the commissioning procedure	28
6.11	Starting up the chemical deficiency sensor system	28
7	Operation	30
7.1	Personnel qualification	30
7.2	Special safety instructions	30
7.3	Notes for optimum washing result	30
7.4	Preparations for washing	31
7.5	Displaying and selecting the program	32
7.6	Washing	33
7.7	Switch off machine	34
7.8	Executing daily cleaning	34
7.9	Executing weekly cleaning	35
7.10	Executing hygiene cleaning	35
7.11	Executing the basic cleaning program for washware	35
7.12	Displaying the temperatures	36
8	Setting options, operating and hygiene data	37
8.1	Overview of operator menu	37
8.2	Opening the operator menu	38
8.3	Navigating, selecting and setting within the menu	38
8.4	Exiting the operator menu	39
8.5	Making the general settings	39
8.6	Setting the display indications	39
8.7	Setting the acoustic signal	40
8.8	Making the chemical settings	40
8.9	Configuring the counter for external water treatment (optional)	41
8.10	Setting the water hardness (optional)	41
8.11	Activate/deactivate VAPOSTOP (optional)	42
8.12	Displaying the operating/hygiene data	42
8.13	Setting automatic switch-on	44
9	Fault indications and problems	46
9.1	Fault indications	46
9.2	Remedying the problem	48
10	Maintenance	50
11	Disposal	51

1 Notes on the documentation

1.1 Application

This document contains the most important information for the installation and commissioning of the machine by qualified personnel, as well as the information required for day-to-day operation by the operator.

- ▶ Keep the operating instructions and all referenced documents in a safe and accessible place.
- ▶ If you sell the machine, pass on the installation and operating instructions.

1.2 Layout of the documentation

Referenced documents are all instructions that describe the installation, operation, maintenance and repair of the device, as well as additional instructions for all accessories used.

For the operator:



- Comic Card (brief instructions)
- Operating instructions

For the specialised tradesman:







- Installation instructions
- Service Manual
- Service Software Manual
- Trouble shooting list
- Circuit diagram
- Spare parts catalogue

1.3 Representation convention

1.3.1 Symbols used

Symbol	Meaning
	Warning of hazardous electrical voltage
	Beware of explosion

Notes on the documentation

Symbol	Meaning
	Warning of risk of crushing
	Beware of hazardous substances
	Beware of hand injuries
	Beware of slipping
	Beware of hazard area
	Useful additional information and tips

1.3.2 Representation in the text

Representa- tion	Meaning
NOTE	Important information on machine operation, not a warning notice
▶	Step
↳	Outcome/result
–	Listing 1st level
•	Listing 2nd level





2 Safety instructions and regulations

2.1 Safety instructions and warning notices

- ▶ During machine operation, observe the general safety instructions and warning notices that precede each action.

2.1.1 Hazard levels

The hazard level is part of the safety instructions and is denoted by the signal word. Potential consequences are differentiated by the choice of signal word.

 DANGER	imminent danger: results in serious physical injury or death
 WARNING	potentially hazardous situation: can cause serious physical injury or death
 CAUTION	potentially hazardous situation: can cause minor physical injury
 NOTICE	potentially harmful situation: can cause damage to the product or other objects

2.1.2 Layout of warning notices

Warning notices are depicted with warning symbols and signal word in the corresponding safety colours.



Nature and source of the hazard

Explanation on the nature and source of the hazard

- ▶ Measures for averting the hazard
- ▶ additional measures for averting the hazard, where applicable

2.2 Basic safety instructions

2.2.1 Product safety

The machine conforms to state-of-the-art technology and the recognised safety regulations. Nonetheless, hazards may occur.

Operate the machine only if it is in perfect working order, and in

Safety instructions and regulations

compliance with the operating instructions.

All modifications and alterations to the product are reserved for persons authorised by HOBART. Configuration is password-protected.

2.2.2 Personnel qualification

- ▶ Observe the regulations on occupational health and safety.
- ▶ Carefully read through the operating instructions before use.

Activity	User group	Qualification/training
Installation	Qualified personnel	Authorised electricians (qualified electricians or persons who have undergone equivalent training)
	Trainees	only under appropriate supervision and inspection
Commissioning	Qualified personnel	Authorised electricians (qualified electricians or persons who have undergone equivalent training)
	Trainees	only under appropriate supervision and inspection
Working on the electrical system	Qualified personnel	Qualified electrician
Operation	Laymen	Training by the operator using the operating instructions, hazard briefing
	Disabled persons	Training by the operator using the operating instructions, hazard briefing
	Children from 14 years old	Training by the operator using the operating instructions, hazard briefing, only under supervision
	Children up to 13 years old	not permitted
Maintenance, repair	Qualified personnel	Hobart Service or Hobart trained service technicians
	Trainees	only under appropriate supervision and inspection

2.2.3 Product-specific hazards

Avoid body parts being crushed or knocked:

- ▶ Observe the instructions on the packaging for storage, lifting or transporting.

Avoid risk of explosion:

- ▶ Do not install machine in a potentially-explosive location.

Avoid electric shock:

- ▶ Do not allow water to flow under live components.
 - Make sure the machine is correctly stored (see frost damage section 2.3).
 - Make sure that the machine does not overflow when being filled.
- ▶ Do not damage the connection cable while unpacking.

Safety instructions and regulations

- ▶ Have the machine connected to the power supply by qualified personnel.
- ▶ Have additional feed tanks mounted by qualified personnel.

Avoid fire risk:

- ▶ Do not allow water to flow under live components.
 - Make sure the machine is correctly stored (see frost damage section 2.3).
 - Make sure that the machine does not overflow when being filled.
- ▶ Have the machine connected to the power supply by qualified personnel.
- ▶ Have all modifications to the machine carried out by qualified personnel.

Avoid chemical burns, sensitisation of the skin, poisoning:

- ▶ Wear protective equipment (gloves, safety goggles, protective clothing) when handling chemicals.
- ▶ Use only suitable chemicals. Observe the manufacturer's data.
- ▶ Have chemical sensor system set by authorised trained service technicians.
- ▶ Do not open the machine during operation, wait for the program to finish.
- ▶ Disconnect the machine from the mains prior to cleaning.
- ▶ For cleaning, wear protective equipment (gloves, safety goggles, protective clothing) when touching parts contaminated by detergent.

Avoid burns, scalds (to the hands):

- ▶ Do not open the machine during operation or the evaporation phase, wait for the program to finish.
- ▶ Disconnect the machine from the mains prior to cleaning.
- ▶ For cleaning, wear protective equipment (gloves, safety goggles, protective clothing) when touching parts contaminated by washing solution.

Avoid slipping:

- ✓ Moisture can build up on the machine floor.
- ▶ Provide a floor covering that is guaranteed to be non-slip in case of moisture.

Residues on the washware, hygiene regulations not maintained.

- ▶ Hygiene regulations must be maintained and/or demonstrated in accordance with the national provisions.

2.2.4 Additional hazards

Potential hazards caused by operating resources to be used can be found in the enclosed safety datasheets. Workplaces must be

Safety instructions and regulations

signed accordingly.

2.3 Property damage

Avoid frost damage:

- ✓ Temperatures below 0°C during transport/storage cause function impairments.
- ▶ Prior to installation, store the machine at room temperature (min. 15°C) for 24h.

Avoid water damage:

- ▶ Configuration is password-protected and permitted only by certified service technicians. Observe documentation.
- ▶ Do not operate the machine unsupervised.
- ▶ Close site shut-off valves at end of operation.

Avoid environmental hazards:

- ▶ Dispose of the machine correctly and in accordance with environmental regulations (see section [11](#))

3 Product description

3.1 Intended purpose

The machine is an item of technical equipment intended solely for commercial dishwashing.

The machine is designed solely for cleaning crockery (porcelain, glass, ceramic, temperature-resistant plastics or stainless steel or similar) from the food industry.

Not for washing:

- Containers that do not come into contact with foodstuffs, such as ashtrays, candlesticks, electric appliances etc.
- Animals or textiles
- Foodstuffs intended for further consumption

3.2 Conformity

See separate EC Conformity Declaration.

3.3 Designation

The rating plate is located at the side of the machine and contains the following information: model, serial number, date of manufacture, country of manufacture, voltage, connection rating, design-state number and CE mark.

3.4 Technical specifications

	AUP	AUPL	AUPT
Height (mm)	1,510	1,610	1,510
Width (mm)	635	735	1,265
Depth (mm)	635	635	635
Water consumption per basket	1.4 to 3.5 l, depending on contamination		
Flow pressure	0.5 – 10 bar bar min. 0.8 bar with integrated softener		
Cold or hot water connection	max. 60°C		
Voltage	see rating plate		
Total connected load			
Fuse protection			
Tank capacity (l)	40	40	80
Rack height	440	540	440

Product description

	AUP	AUPL	AUPT
Noise emission dB (A) (workplace-related emission value)	67	68	71
Weight (kg)	140	150	208

4 Controls



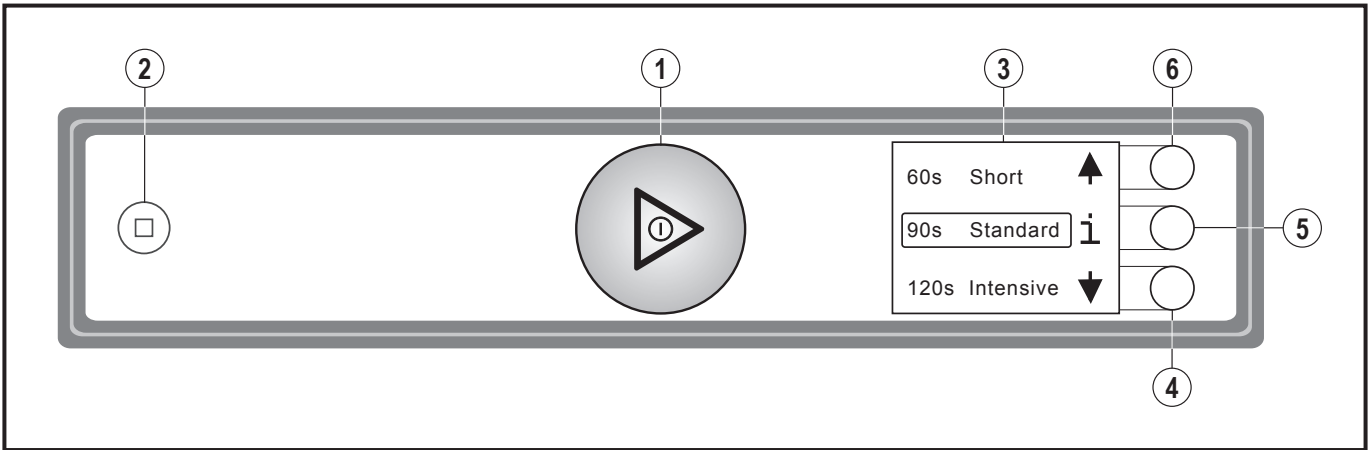

4.1 Controls

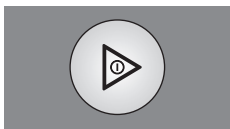

①	ON/OFF button	<p>Pressing this button switches the machine on.</p> <p>As soon as the machine is ready for operation, the rinse program can be started by closing the hood.</p> <p>Briefly pushing this button while the program is running activates high-pressure washing.</p> <p>Pushing and holding (3 seconds) the button activates the automatic drain and self-cleaning cycle and switches off the machine automatically. After switch off, however, the machine is not voltage free!</p> <p>The button also shows the current operating state through different colors (see sections 4.2 and 4.3)</p>
②	STOP button	<p>In case of operating error or faults, the machine can be switched off immediately without the drain cycle by pressing this key.</p> <p>After switch off, however, the machine is not voltage free!</p>
③	Display	Selection menu/fault and information displays
④	Display navigation button	Scroll/set/select
⑤	Display navigation button	Change menu level/confirm/back/acknowledge fault
⑥	Display navigation button	Scroll/set/select

4.2 Operating states

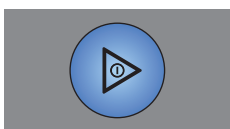
In the operating panel display, the ON/OFF switch shows the current operating state through different colours.

	<p>Machine is Off</p> <p>The ON/OFF button is colourless.</p>
	<p>Machine being prepared for operation</p> <p>The ON/OFF button gradually goes green. The wash tank is being filled and the machine is heating up.</p>
	<p>Machine ready</p> <ul style="list-style-type: none"> – The ON/OFF button illuminates completely green. – The machine is ready for the next wash cycle.
	<p>Wash program starts</p> <ul style="list-style-type: none"> – The ON/OFF button illuminates completely blue.
	<p>Machine is washing</p> <ul style="list-style-type: none"> – The ON/OFF button changes segment-by-segment from blue back to completely green.
	<p>VAPOSTOP (vaporisation phase)</p> <ul style="list-style-type: none"> – The ON/OFF button display a permanently revolving blue segment.
	<p>Switch off machine</p> <ul style="list-style-type: none"> – The ON/OFF button changes segment-by-segment from green to colourless. – The machine is being emptied and switched off.

4.3 Display of faults and information

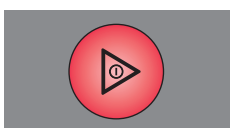
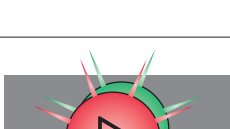
	<p>Fault: operation not possible</p> <ul style="list-style-type: none"> – The ON/OFF button illuminates permanently red. – The fault is displayed. – For potential faults, see section 9.1
	<p>Information: limited operation is possible</p> <ul style="list-style-type: none"> – The ON/OFF button illuminates green/red alternately. – The information is displayed. – For potential information, see section 9.1

4.4 Display function

The display is activated (when the machine is turned on) by pushing the display navigation buttons or moving your hand near to the display.

On activation, the wash program selection appears first. The selected program or function is highlighted.

The function of the display navigation buttons is context-dependent and shown in the display by symbols.

Further displays/menu levels can be selected using the ⓘ button. If no button is pushed, the display de-activates again after 10s.

4.5 Overview of main menus

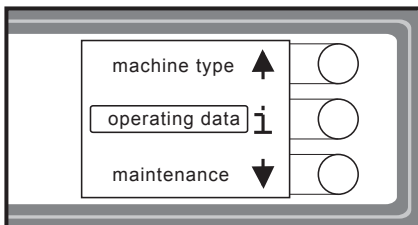
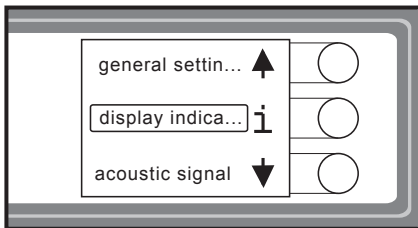
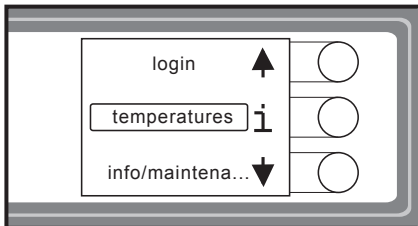
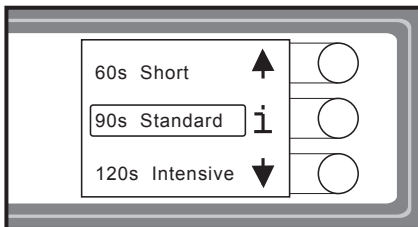

Program selection and info:

- Selects possible wash programs (depends on model variants)
- The ⓘ ("i") button accesses the **Login/Temperatures/Info** menu

Login/Temperatures/Info:

- Login: Operator code accesses **Operator menu**
- Temperatures: Displays tank and rinse temperatures.
- Info/service: Accesses the **Info/Service** menu

Operator menu:

- Gen. settings: Accesses the machine settings
- Display indications: Accesses display settings
- Acoustic signal: Accesses the signal sensor setting
- ... see also section [8.1](#).







Info/Service:

- Machine type: Indicates machine type and serial number.
- Operating data: Displays operating data (see section [8.12](#)).
- Service: Displays service address.





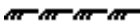







4.6 Overview of display symbols





4.6.1 Wash cycle symbols

As an alternative to the text display, it is possible to switch to the symbol display (see section 8.6).

Symbol	Program
	Short
	Standard
	Intensive
	Eco
	Continuous
	Cutlery
	Hygiene

4.6.2 Function symbols

Symbol	Function
	Scroll menu
	Accept value
	Alter value
	Info/Service
	Login
	back
	Temperatures
	Wash/rinse temperatures
	Sound on/sound off
	Timer
	Salt deficiency
	Chemical deficiency

Symbol	Function
	Fault
	Fill fault
	Drain fault
	Heating element fault

Installation

5 Installation

5.1 Personnel qualification

Installation must only be carried out by qualified personnel (see section 2.2.2).

5.2 Special safety instructions

**! WARNING****Risk of electric shock, fire hazard**

Water (frost damage, machine overflow) flowing over live components can cause injury from electric shock or fire.

- ▶ Do not allow water to flow under live components.
- ▶ Make sure the machine is correctly stored (see frost damage section 2.3).
- ▶ Make sure that the machine does not overflow when being filled.

**! CAUTION****Risk of being crushed or knocked**

When being lifted or transported, the machine can overturn or fall and cause injury.

- ▶ Observe the instructions on the packaging for storage, lifting or transporting.

**! WARNING****Risk of explosion**

Installing the machine in a potentially explosive location can cause explosion and serious injury from ejected parts.

- ▶ Do not install machine in a potentially-explosive location.

NOTICE**Frost damage**

Temperatures below 0°C during transport/storage cause function impairments.

- ▶ Prior to installation, store the machine at room temperature (min. 15°C) for 24h.

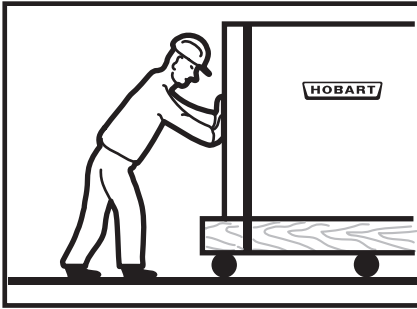

5.3 Transporting to the installation location

- ▶ Where possible transport packed on the pallet.
- ▶ Use suitable transport means (elevating truck, crane etc.).
- ▶ If using a forklift, shim the machine with wooden trusses.

5.4 Removing the packaging



CAUTION

Risk of electric shock, fire hazard

When the machine is unpacked, the connection cable can become damaged and cause injury from electric shock or fire.

- ▶ Do not damage the connection cable while unpacking the machine.
- ▶ Take cable measurement BGV A3.

- ▶ Remove packaging materials and accessories from the machine.
- ▶ Inspect the machine for possible transport damage.

5.5 Installing the machine



WARNING

Risk of electric shock, fire hazard

Water ingress can cause short circuit and mortal danger from electric shock and fire.

- ▶ As a protection against penetrating water, the rear side of the machine must be sealed.
- ▶ If this cannot be guaranteed, a back covering must be also ordered.

- ▶ Seal the machine against the wall, or attach the optionally-available back covering.
- ▶ Cut-outs in the rear machine frame for supply lines etc., must also be sealed (sealing kit 01-539610-001 optionally available).
- ▶ Align machine by turning the adjusting feet by using a spirit level.

Installing the machine in the corner:

- ▶ Maintain a side wall clearance of 107 mm.

Installing the machine in a room:

- ▶ Attach the optionally-available back covering.

Installation

Converting to corner operation

Modify the basket guide rails in accordance with the pass-through direction (see arrows):

- ▶ Remove the front side guides by loosening the screws.

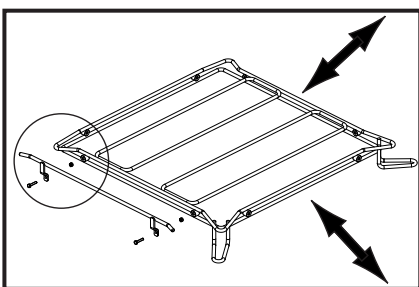
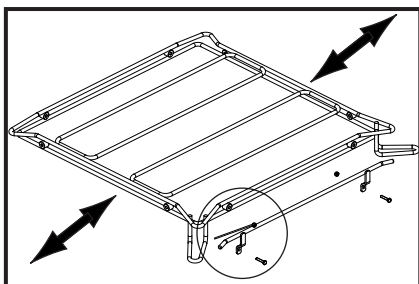

- ▶ Re-mount the side guide in accordance with the pass-through direction.

5.6 Connecting to the power supply

WARNING

Risk of electric shock

Failure to connect properly to the power supply can cause mortal danger from electric shock.

- ▶ Have the machine connected to the power supply only by qualified personnel.



NOTE: To guarantee the electrical safety of the machine, it must be connected to a protective earthing equipment conductor installed as specified. In addition, the machine must be connected on site to the equipotential bonding connection. The connecting screw () provided for this purpose is located next to the cable inlet.

These fundamental safety requirements and the professional design of the on-site installation must be verified by a qualified electrician.

Hobart does not accept any liability for damage caused by improper installation! Any applicable local installation instructions must be observed!

The mains cable must be connected via a cut-out device (main switch or accessible plug device).

Modification to an alternative power supply is possible as per the variants on the circuit diagram. Connection diagrams are located adjacent to the connection terminals.

Only for machines with three-phase current wash pumps

To verify the correct three-phase current connection, the rotating direction of the wash pump(s) must be checked as follows:

- ▶ Push a cable tie approx. 3 cm through the rear side air grille.
- ▶ Check whether the fan impeller rotates counter-clockwise (in the direction of the arrow).

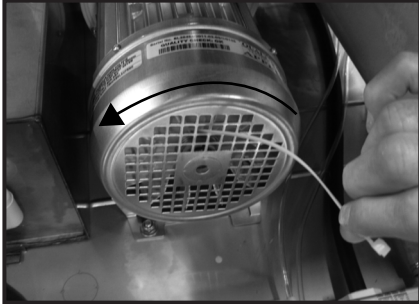

- ▶ If not, interchange two of the three phase on the feed cable.

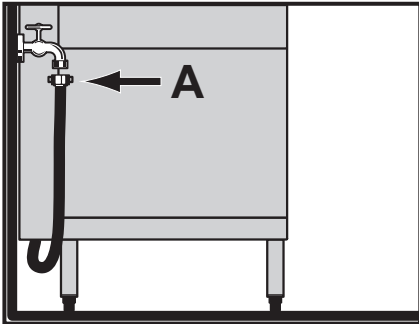
**5.7 Connecting the water**

NOTE: The machine must be operated with potable water.

- ▶ If possible, connect to warm water (max. 60°C).
- ▶ Machines with drain heat recovery: If possible connect to cold water (approx. 10 °C).

Water hardness:

- Machines without softener: max. 1 °d = 0.18 mmol/l.
- Machines with softener: max. 30 °d = 5.3 mmol/l.

Flow pressure:

- Machines without softener: 0.5 – 10 bar
- Machines with softener: 0.8 – 10 bar
- If the flow pressure is above 10 bar: provide pressure reducing valve.
- ▶ Connect the union nut "A" (3/4" thread) of the water supply hose to the site shut off valve.
- ▶ Do not kink or cut the water supply hose.
- ▶ Any required extension must be executed using a suitable pressure hose, e.g. 324088-1.

Installation

5.8 Connect steam (optional)

CAUTION
Burns, scalds

During connection, hot pipelines and fittings can cause burns. Steam can escape and cause scalding.

- ▶ Before connecting, lock-off the site steam supply and secure to prevent "restart".
- ▶ Wear protective gloves.

NOTE: On site, make sure that the permissible pressures and temperatures cannot be exceeded.



The fittings required for operation are built into the machine.

- ▶ Connect to the site steam line.

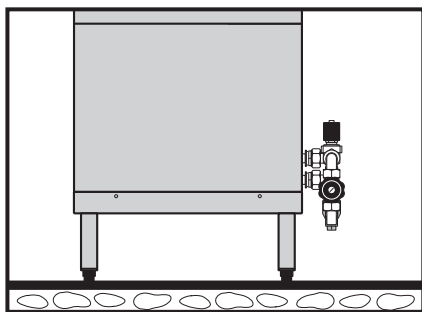

- DN 20 pipe
- Flow pressure: 0.5 - 3.5 bar
- Temperature: max. 150°C
- See rating plate!
- ▶ Dimension steam and condensate line accordingly.

5.9 Connecting the drain

The connection between machine and site drain must not exceed the max. height of 0.75 m.

- ▶ Do not kink or lay the drain hose loose on the ground.

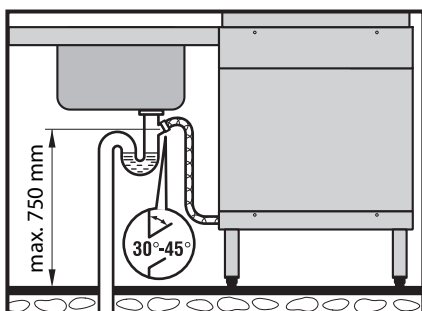

5.10 Connecting the dispenser

As a rule, all model variants are factory-equipped with integrated dispensers. To convert to different dispensers, make the connection as follows.

- ▶ Drain tank.
- ▶ Turn off the site main switch or remove the plug.
- ▶ Remove frontal covering.

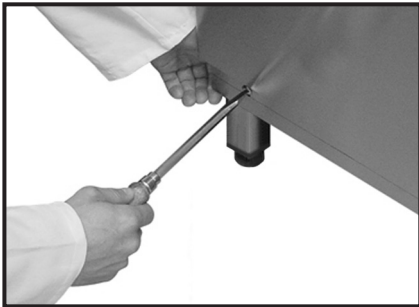

Connecting the liquid dispenser:

- ▶ A metering nipple is available on top of the boiler for dispensing rinse aid.
- ▶ For detergent dosing, connect the hose (PVC / Ø 6 mm outside × Ø 4 mm inside) between the pressure side of the dispenser and the metering nipple (A) on the wash tank, secure with hose clamp.

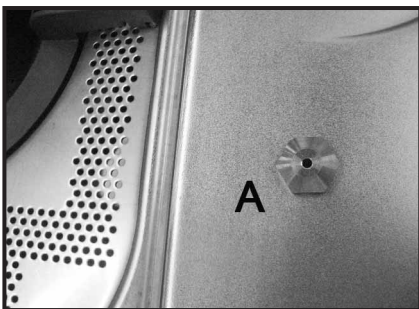

- ▶ Install dispenser or mount externally.



To connect a powder or solid detergent dispenser:

- ▶ Remove the side cover (depending on left or right connection).
- ▶ Break out sheet perforation on the sheet outer jacket.

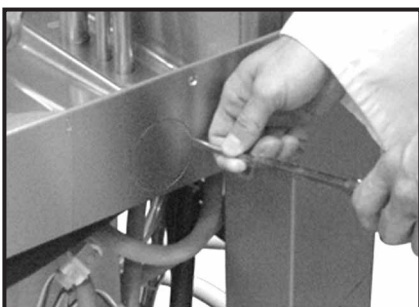

Installation

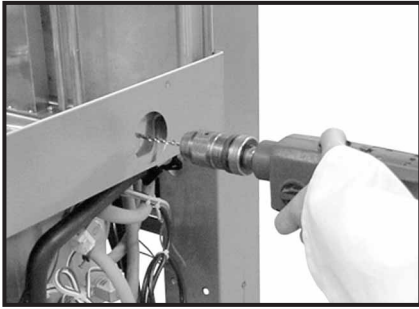

- ▶ Drill out the inner tank wall behind according to the required connection diameter.

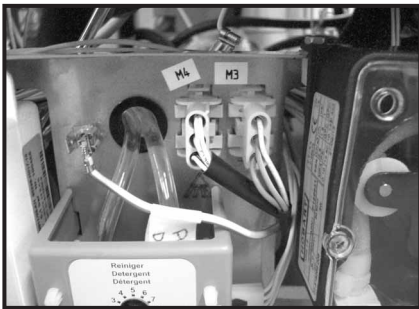

- ▶ Screw the dosing connection tightly to the tank wall.
- ▶ Connect the plug of the cable harness to the dispenser (max. 100 VA).

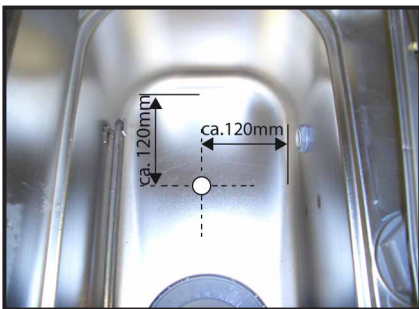

Installing the connectivity probe:

- ▶ Conductivity probe should be installed at the flat part of tank bottom.
- ▶ Drill out the tank according to the probe diameter.

- ▶ Replace cover(s).
- ▶ Turn on site main switch or insert the plug.
- ▶ Set the dispenser and the sensor system.

5.11 Install the automatic soil removal unit

See accompanying probe documentation.

6 Commissioning

6.1 Personnel qualification

Commissioning must only be carried out by qualified personnel (see section 2.2.2).

6.2 Special safety instructions

NOTE: Before commissioning the machine, the relevant electrical safety checks must be performed according to the locally applicable regulations!

6.3 Starting the commissioning procedure

When the machine is turned on for the first time, the commissioning procedure starts automatically with the language selection, followed by further requisite commissioning steps.

- ▶ Push ON/OFF button ①.
 - ↳ Display is activated.
 - ↳ **Language** menu is displayed.

6.4 Setting the language

- ▶ Push display navigation button ④ or ⑥ until the required language is highlighted.
- ▶ Push button ⑤.
 - ↳ The language is activated.
 - ↳ **Set day** menu is displayed.

6.5 Setting the date

- ▶ Push display navigation button ④ or ⑥ until the required day is highlighted.
- ▶ Confirm with button ⑤ and skip to set month.
- ▶ Repeat the procedure as described to enter month and year.
- ▶ Push button ⑤.
 - ↳ The date is activated.
 - ↳ **Set time** menu is displayed.

6.6 Setting the time

- ▶ Push display navigation button ④ or ⑥ until the required hour is highlighted.
- ▶ Confirm with button ⑤ and skip to set minutes.
- ▶ Push display navigation button ④ or ⑥ until the required minute is highlighted.
- ▶ Push button ⑤.
 - ↳ The time is activated.

6.7 Setting the water hardness (optional)

Machines with integrated softener have a water hardness setting.

Note: The softener must be set to the existing water hardness (ask at the local water works).

- ▶ Push display navigation button ④ or ⑥ until the required hardness is set.
- ▶ Push button ⑤.
 - ↳ Water hardness is activated.

6.8 Filling the salt reservoir (optional)

On machines with integrated softener, an instruction to fill the salt reservoir appears during commissioning.

NOTICE

Property damage

Accidentally filling the salt reservoir with detergent will damage the water softener.

- ▶ Do not fill the salt reservoir with detergent.



Unlike the regular salt fill, additional water has to be added during the commissioning procedure.

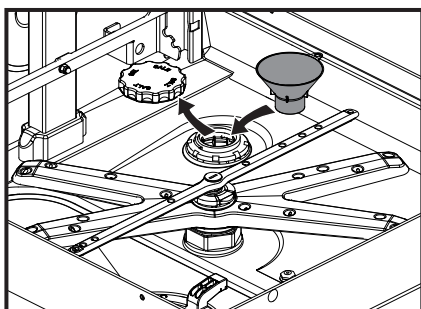

- ▶ Open hood.
- ▶ Unscrew the salt reservoir lid and use the funnel provided to add 1.5 kg of granular (2-8 mm) regenerating salt (do not use salt tablets).

- ▶ Fill up the reservoir with potable water (only at commissioning).
- ▶ Make sure the lid seal is free of soil and salt.
- ▶ Screw lid back on and tighten.

NOTICE

Property damage

Salt residues on the tank floor cause corrosion damage.

- ▶ Remove salt residues by hand.
- ▶ On completion of the commissioning procedure, start a wash cycle to remove all traces of salt if necessary.

- ▶ To continue the commissioning procedure, press button ⑤.

6.9 Filling chemical hoses



We recommend the use of HOBART Hyline detergent and rinse aid.



CAUTION

Chemical burns, sensitisation of the skin, poisoning

The use of unsuitable chemicals can cause injury.

- ▶ Use only commercial detergent and rinse aid.
- ▶ Observe the manufacturer's application and safety instructions.



WARNING

Chemical burns, sensitisation of the skin, poisoning

Filling the chemical container or chemical hoses with detergent or rinse aid for the first time incorrectly can cause serious injury.

- ▶ Wear protective equipment (gloves, safety goggles, protective clothing) when handling chemicals.



6.9.1 Provisioning external chemical canisters

During the commissioning procedure, an instruction for inserting the suction hoses into the external canisters appears in the display.

Preparing the detergent:

- ✓ Suction height of dosing pump: max. 1.5 m.
- ▶ Place suction hose **without** colour marking at the suction valve at the bottom of the external reservoir.

Preparing the rinse aid:

- ✓ Suction height of dosing pump: max. 1.5 m.
- ▶ Place suction hose with **blue** marking at the suction valve at the

bottom of the external reservoir.

Filling the suction hoses:

- ▶ Push button ⑤.
 - ↳ The instruction “Close the machine hood” is displayed.
- ▶ Close the hood and push button ⑤.
 - ↳ Chemical hose filling is activated.

The filling process is visualised in the display by a time bar.

6.10 Completing the commissioning procedure

The machine can be started or switched off selectively.

- ▶ Push display navigation button ④ or ⑥ until the required setting is highlighted.
- ▶ Push button ⑤.
 - ↳ The setting is activated.

6.11 Starting up the chemical deficiency sensor system



WARNING

Chemical burns, sensitisation of the skin, poisoning

Incorrect procedure when commissioning the chemical sensor system can cause serious injury.

- ▶ Have chemical sensor system set by authorised service technicians.
-
- ▶ Before removing the trim components, disconnect the machine from the power supply.
 - ▶ Execute hose filling via the operator menu (see section 8.8).
 - ▶ Observe until the sensor-operated filling of both hoses is complete.
 - ↳ The control LEDs must now illuminate.

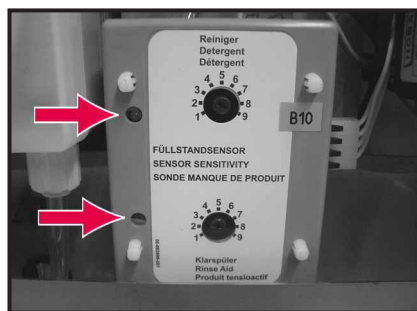

- ▶ If necessary, readjust the potentiometers (increase setting).
 - Factory setting for detergent = 3

-
- Factory setting for rinse aid = 5
 - ▶ Switch on sensor system in the service menu. Contact your HOBART Service Partner.

7 Operation

7.1 Personnel qualification

The machine must be operated by instructed personnel (see section 2.2.2).

7.2 Special safety instructions



CAUTION

Chemical burns, sensitisation of the skin, poisoning

If the Hood is opened during operation, wash water can spurt out and cause injury.

- ▶ Do not open the Hood during operation, wait for the program to finish.



WARNING

Slipping

Moisture can build up on the machine floor and cause slipping.

- ▶ Provide a floor covering that is guaranteed to be non-slip in case of moisture.

7.3 Notes for optimum washing result

The rinse result is significantly affected by the water quality. If the mineral content is high, the minerals dissolved become visible on the glasses in the form of spots and streaks during the drying process.



Authorised HOBART service personnel can determine the content of minerals by measuring the electrical conductivity. Values of less than 80 µS/cm are non-critical for rinsing glasses and cutlery. If the values are higher, we recommend the use of a HOBART HYDROLINE desalination cartridge or a reverse osmosis system.

If you have any questions, please contact your authorised HOBART service partner.



We recommend the use of special HOBART glass racks. HOBART racks hold the glasses in slightly inclined positions – this improves the rinse efficiency.

To avoid unpleasant smelling glasses, only chlorine-free detergent

should be used for washing the glasses.

Before washing new glasses the first time with a commercial glass washer, intensive basic cleaning is mandatory to reduce the greasy film which is on most glasses for protection during production. We recommend this basic clean is carried out by hand (wear gloves) with a higher detergent concentration (minimum 10 g/l) in a sink using a brush. Alternatively, the program described in section 7.11 can also be used.

7.4 Preparations for washing

7.4.1 Preparing the machine

- ▶ Check correct position of wash/rinse arms and strainers.
- ▶ Open site shut-off valve.
- ▶ Turn on main switch or insert the plug.
- ▶ Check level of detergent and rinse aid containers.
- ▶ Close hood.
- ▶ Push the ON/OFF button ①.
 - ↳ Machine is switched on.
 - ↳ The tank is filled.

The ON/OFF button will become gradually green during fill and heating cycle. This process can take several minutes.

When the button becomes completely green, the machine is ready for operation.

7.4.2 Preparing the washware

The dishwasher is fitted with an automatic soil removal unit (ASR). The ASR automatically performs the manual rinsing of lightly soiled washware.





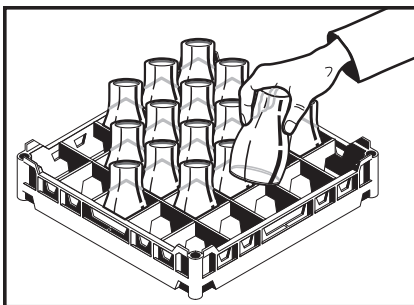

NOTE: Large food scraps have to be removed manually. Dried-on soiling must be pre-treated.

- ▶ Remove large food scraps.
- ▶ Place washware face down in the rack.



7.5 Displaying and selecting the program

7.5.1 Overview of programs and additional functions

Name	Description	Alternative symbol display
Short	For slight contamination	
Standard	For normal contamination	
Intensive	For heavier soiling	
Eco	With steam rinse aid (reduces water and chemical consumption)	
Continuous	For heavy contamination	
Cutlery	For thorough cutlery cleaning	
Hygiene	(see also section 7.10)	
Basic clean	Program for removing stubborn coatings/deposits on washware (see section 7.11)	without
High-pressure washing	For washing heavily contaminated pressure-sensitive washware (see also 7.6.1).	without

7.5.2 Displaying and selecting the program

The machine rinses automatically using the standard program. If necessary, a different program can be selected.

- ▶ To display the current program before the start, activate the infrared sensor in the display by hand or push the display navigation button.
 - ↳ Display is activated.
 - ↳ **Program selection and info** menu is displayed.
 - ↳ The program currently selected is highlighted.
- ▶ To switch to a different program, push ④ or ⑥ navigation button until the required program appears and is highlighted.

The selected program can be started directly by closing the hood.

The machine continues with last program to be selected until it is switched off.

7.6 Washing

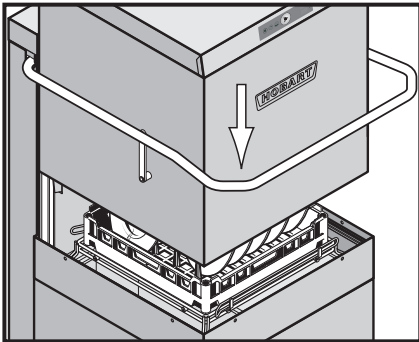

- ▶ Slide rack into the machine and close the hood.

- ↳ While the program is running, the ON/OFF button gradually changes from blue back to green.
- ↳ As soon as the ON/OFF button illuminates green again, the rinse cycle is finished.

- ▶ Open the hood and remove the rack.
- ▶ Allow the washware enough time to dry.
- ▶ Until the next wash process, place the hood in the stand-by position (engaged position just before closing), to prevent cooling down.

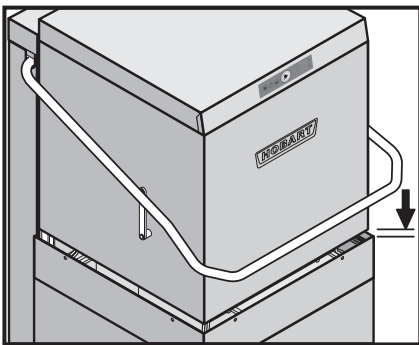

Machines with VAPOSTOP

For models with VAPOSTOP, a condensate phase (30 sec.) is also carried out after rinsing. This is indicated by a blue segment rotating to green and by the remaining run time in seconds on the display. If necessary, this phase can be interrupted at anytime by opening the hood.

7.6.1 Manually activating and deactivating high-pressure washing

To wash severely contaminated washware, the manual high-pressure wash can be activated in addition.

Activating high-pressure washing:

- ✓ While the rinse program is running,
 - ▶ briefly press the ON/OFF button ①.
 - ↳ The high-pressure washing is activated until end of program.

Deactivating high-pressure washing:

- ▶ Wait until end of program.
 - ↳ The high-pressure washing is automatically deactivated at

end of program.

7.6.2 Ending a continuous program

A running continuous program can be ended prematurely as follows.

- ▶ Push the ON/OFF button ①.
 - ↳ The rinse cycle starts after a short pause.
 - ↳ The continuous program is ended.

The program also ends automatically after 20 minutes.

7.7 Switch off machine

- ▶ Close hood.
- ▶ Push the ON/OFF button ① for 3 seconds.
 - ↳ During pump-out, the ON/OFF button gradually changes from green back to colourless.



During the drain cycle, the machine interior is cleaned automatically. Then remove any food debris.

- ✓ When the ON/OFF button has extinguished completely:
 - ▶ Turn off main switch or remove the plug.
 - ▶ Close on-site shut-off valve.

7.8 Executing daily cleaning

NOTICE

Property damage

The use of unsuitable agents can cause corrosion damage.

- ▶ Do not use any chloric, acidic or metal-containing additives to clean the machine.
 - ▶ Do not use metal brushes.
-

- ▶ Open hood.
- ▶ Remove sieves and clean. **Make sure that food debris does not enter pump intake!**
- ▶ Clean the soil collector container daily.
- ▶ Clean machine areas that cannot be reached by the water circulation of the self cleaner (hood labyrinth, rear side riser pipe, etc.).
- ▶ Replace strainer.
- ▶ Leave the hood open for ventilation.

7.9 Executing weekly cleaning

- ▶ Push and hold the clip fastener on the wash and rinse arms. Remove the wash and rinse arms and clean.
- ▶ Reinsert wash and rinse arms.

7.10 Executing hygiene cleaning

When a pre-set number of rinse cycles has been reached, the instruction "Execute hygiene program" appears in the display, indicating that an automatic hygiene clean of the machine interior should be executed.

- ▶ Before end of operation, remove the rack and place two HO-BART cleaning tablets in the machine interior.
- ▶ Close hood.
- ▶ Push ④ or ⑥ navigation button until the hygiene program appears and is highlighted.
- ▶ Press the ON/OFF button ①.

While the hygiene program is running (duration approx. 20 minutes), the green illuminated segments extinguish successively.

At the end of the program, the machine switches off automatically.



If necessary, hygiene clean should be executed before the pre-set number of rinse cycles is reached. With regular use, the machine interior will remain free of food debris and deposits.

7.11 Executing the basic cleaning program for washware

Special program for removing stubborn coatings/deposits on washware (e.g. protective film on new glasses, starch residues)



CAUTION

Chemical burns, sensitisation of the skin, poisoning

The use of unsuitable chemicals can cause injury.

- ▶ Carry out the manual addition of a special agent according to the recommendation of your chemical supplier.
- ▶ Observe the manufacturer's application and safety instructions.



- ▶ Open hood.
- ▶ Manually remove coarse soiling from tank cover.

Operation

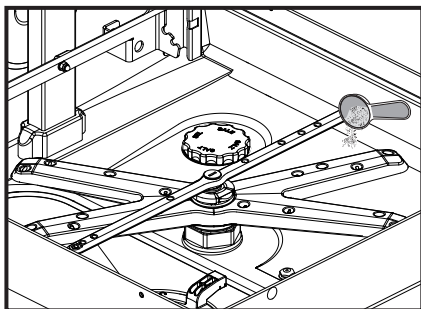

- ▶ According to the individual dosing recommendations, add the powder quantity required for the tank content (see 3.4) to the flat side of the tank.

- ▶ Activate the infrared sensor in the display by hand or push the display navigation button.
 - ↳ Display is activated.
 - ↳ **Program selection and info** menu is displayed.
- ▶ Push ④ or ⑥ navigation button until the basic cleaning program appears and is highlighted.
- ▶ Slide the loaded rack into the machine and close the hood.
- ▶ Push the ON/OFF button ①.
 - ↳ While the program is running (duration approx. 10 minutes), the ON/OFF button ① gradually changes from blue back to green.

As soon as the ON/OFF button illuminates green again, the rinse cycle is finished.



For each basic cleaning cycle that follows immediately, an additional manual dosing is required for 4 litres of water.

7.12 Displaying the temperatures

This menu option is for displaying the current tank and rinsing temperatures.

Procedure:

- ▶ Activate the infrared sensor in the display by hand or push one of the display navigation buttons.
 - ↳ Display is activated.
 - ↳ **Program selection and info** menu is displayed.
- ▶ Push button .
 - ↳ **Login/Temperatures/Info** menu is displayed.
- ▶ Select the **Temperatures** menu option.
 - ↳ Current tank and rinsing temperatures are displayed.

Setting options, operating and hygiene data

8 Setting options, operating and hygiene data

The machine can be operated as soon as the commissioning procedure is complete.

The following settings can be individually set as required using the operator menu.

8.1 Overview of operator menu

Sub-menu	Function
General settings	Language Date Time Date format Time format Temperature unit
Display indications	Program representation Brightness Adjust contrast
Acoustic signal	On/Off
Chemical settings	Detergent dosing Rinse aid dosing Filling chemical hoses
External water treatment (only when activated by HOBART Service)	Set counter Reset counter Remaining water quantity
Hardness	Setting
VAPOSTOP	Activating Deactivating
Operating/hygiene data	Display operating data Display hygiene data Transmit report
Timer	Weekly program Timer program Activate/deactivate

Setting options, operating and hygiene data

8.2 Opening the operator menu

- ✓ The machine must be switched on.
- ▶ Activate the infrared sensor in the display by hand or push one of the display navigation buttons.
 - ↳ Display is activated.
 - ↳ **Program selection and info** menu is displayed.
- ▶ Push button ⑤.
 - ↳ **Login/Temperatures/Info** menu is displayed.
- ▶ Push display navigation button ⑥ until **Login** is highlighted.
- ▶ Push button ⑤.
 - ↳ Enter PIN is displayed.

Enter operator code "1111":

- ▶ Push display navigation button ④ or ⑥ until a "1" is shown in the first place.
- ▶ Push button ⑤ and skip to the next number.
- ▶ Repeat the procedure as described until all numbers are entered.

The operator menu is displayed once the correct code has been entered.

8.3 Navigating, selecting and setting within the menu

Navigating and opening sub-menu:

- ▶ Push ④ or ⑥ navigation button until the required sub-menu appears and is highlighted.
- ▶ Push button ⑤.
 - ↳ Menu is displayed.

Making and activating settings:

- ▶ Push display navigation button ④ or ⑥ until the required setting is displayed and highlighted.
- ▶ Push button ⑤.
 - ↳ The setting is activated.

Back:

- ▶ Push ④ or ⑥ navigation button until the **Back** menu option appears and is highlighted.
- ▶ Push button ⑤.
 - ↳ The next highest menu level is displayed.

Setting options, operating and hygiene data

8.4 Exiting the operator menu

- ▶ Open the Hood and close it again, or do not press a button for 10 seconds!

8.5 Making the general settings

The following settings can be entered into the **General settings** sub-menu.

Setting	Selection
Language	is set as default during commissioning, see sections 6.4 to 6.6
Date	
Time	
Date format	YYYY.MM.DD DD.MM.YYYY MM.DD.YYYY
Time format	24h/12h
Temperature unit	°C / °F

Making the settings:

- ▶ Open the operator menu, see section [8.2](#).
- ▶ Open the **General settings** sub-menu and make the setting, see section [8.3](#).

8.6 Setting the display indications

The following settings can be entered into the **Display indications** sub-menu.

Setting	Selection
Program representation	Text display Symbol display (see section 4.6.1)
Display brightness	Set brightness
Display contrast	Set contrast

Making the settings:

- ▶ Open the operator menu, see section [8.2](#).
- ▶ Open the **Display indications** sub-menu and make the setting, see section [8.3](#).

Setting options, operating and hygiene data

8.7 Setting the acoustic signal

An acoustic signal can be switched on or off in the **Acoustic signal** sub-menu.

Setting	Selection
Set signal sensor	Sound on/sound off

Making the settings:

- ▶ Open the operator menu, see section 8.2.
- ▶ Open the **Acoustic signal** sub-menu and make the setting, see section 8.3.

8.8 Making the chemical settings

The following settings can be entered into the **Chemical settings** sub-menu.

Setting	Selection
Detergent dosing	Factory setting: 2.5 g/l Possible range: 0–9.5 g
Rinse aid dosing	Factory setting: 0.3 g/l Possible range: 0–2.0 g/l
Filling chemical hoses	Fill detergent dosing hose NO/YES Fill rinse aid dosing hose NO/YES

Making the settings:

- ▶ Open the operator menu, see section 8.2.
- ▶ Open the **Chemical settings** sub-menu and make the setting, see section 8.3.

If in the **Fill chemical hoses** sub-menu, the prompt **Fill detergent dosing hose** and/or **Fill rinse aid dosing hose** are set to **Yes**, the filling process will start.

The filling process is visualised in the display by a time bar.

It can be stopped by pushing button Ⓢ if necessary.

Setting options, operating and hygiene data

8.9 Configuring the counter for external water treatment (optional)

The following settings for an optional external water treatment can be entered into the **External water treatment** sub-menu.

Setting	Selection
Set counter	Set counter Factory setting: not activated
Reset counter	Reset counter NO Reset counter YES
Remaining water quantity	Remaining capacity for external water treatment Displays the current demineralisation counter status (water quantity remaining until the desalination cartridge is depleted).

Making the settings:

- ▶ Open the operator menu, see section 8.2.
- ▶ Open the **External water treatment** sub-menu and make the setting, see section 8.3.

8.10 Setting the water hardness (optional)

With optional softener only.

Note: The softener must be set to the existing water hardness (ask at the local water works).

The following settings can be entered into the **Set water hardness** sub-menu.

Setting	Selection
Water hardness setting	is set as default during commissioning Factory setting: 30°dH Possible range: 0–30°dH

Making the settings:

- ▶ Open the operator menu, see section 8.2.
- ▶ Open the **Set water hardness** sub-menu and make the setting, see setting 8.3.

Setting options, operating and hygiene data

8.11 Activate/deactivate VAPOSTOP (optional)

Only for models with the VAPOSTOP option.

In the **VAPOSTOP** sub-menu, a condensate phase (30 sec.) can only be activated or deactivated after rinsing.

Setting	Selection
VAPOSTOP	Activating
	Deactivating

Making the settings:

- ▶ Open the operator menu, see section [8.2](#).
- ▶ Open the **VAPOSTOP** sub-menu and make the setting, see section [8.3](#).

8.12 Displaying the operating/hygiene data

The following data can be called-up from the **Operating/hygiene data** sub-menu.

Setting	Selection
Display operating data	Commissioning date
	Operating hours until next service
	Operating hours overall
	Wash cycles overall
	Water consumption overall
	Operating days/hours
	Daily wash cycles
	Daily water consumption
	Remaining capacity for external water treatment
Hygiene data	See section 8.12.1
Report	See section 8.12.2

Display the setting:

- ▶ Open the operator menu, see section [8.2](#).
- ▶ Open the **Operating/hygiene data** sub-menu.
- ▶ Open the corresponding sub-menu and display the setting, see section [8.3](#).

Setting options, operating and hygiene data

8.12.1 Display hygiene data

Hygiene-relevant events, data and messages are listed in this menu option.

The list starts with the current date and the last event that occurred on this day. The subsequent events occurring on this day then appear, followed by the events occurring the day before.

A maximum of 1500 events are saved. Older lists are deleted.

Pushing button  opens the list of completed wash programs.

The following data are saved:

Hygiene data	Program set point temperature too low
	Thermal disinfection aborted
	Wash process aborted
Messages	Rinse aid empty
	Rinse aid deficiency remedied
	Detergent empty
	Detergent deficiency remedied
	Salt empty
	Salt deficiency remedied
	Service interval expired
	Half-cartridge depleted
Events	Filling program
	Pump-out program
Washing program	

8.12.2 Transmit report

This menu option is for transmitting operating and hygiene-relevant data in txt format to a USB stick. This format can be imported and processed using standard software.

Procedure:

- ▶ Open the door.
- ▶ Remove sealing cover from USB port (right side cover).
- ▶ Insert USB stick into the port.
- ▶ Select the **Report** menu option.
 - ↳ After a successful download, a message appears in the display.
- ▶ Remove USB stick.
- ▶ Close off USB port with the sealing cover.

Setting options, operating and hygiene data

8.13 Setting automatic switch-on

The **Timer** sub-menu is for defining times for automatic machine switch-on.

This can be done in two ways:

- The **Weekly program** menu option can be used to define various switch-on times for individual weekdays.
- The **Daily Timer program** can be used to define a non-recurring switch-on time for today's date.

The switch-on must be set to active via the separate **Activate/deactivate** menu option. The text frame shows the most recently selected of the four options. When switch-on is activated, a small clock symbol remains in the top left-hand section of the display for 30 minutes after the machine has been turned off.

Setting	Selection
Weekly program	Weekdays and times
Daily Timer program	Date and time
Activate/deactivate	Weekly timer ON Daily Timer program ON Weekly and Daily Timer program ON Timer OFF

Making the settings:

- ▶ Open the operator menu, see section 8.2.
- ▶ Open the **Timer** sub-menu and make the setting, see section 8.3.

Daily Timer program

The date and time can be selected and altered using the display navigation buttons.

The switch-on must also be set to active via the separate **Activate/deactivate** menu option.

When the time and date are reached, the machine switches on.

Weekly program

Weekdays and an individual switch-on time can be selected and altered using the display navigation buttons.

For weekdays on which **no** switch-on is to occur, **no** time may be saved.

After the switch-on times for each weekday have been entered, the switch-on must be set to active via the separate **Activate/deactivate** menu option.

When the time is reached, the machine switches on.

Activate/deactivate

The **Activate/deactivate** menu option offers the following four selection options:

- **Daily timer on:** Automatic switch-on is activated for an **entered day's date**.
- **Weekly timer on:** Automatic switch-on is activated for the **saved weekdays and individual times**.

Setting options, operating and hygiene data

- **Daily and weekly timer on:** Automatic switch-on is activated for an **entered day's date and for the saved weekdays**.
- **Timer off:** Automatic switch-on is **generally deactivated**.

Fault indications and problems

9 Fault indications and problems

9.1 Fault indications

Displayed error messages are shown in the order of priority. They **must** be acknowledged via the display navigation button ③.

Acknowledged error messages for which the error is still pending are first hidden to enable further messages to be displayed.

If all fault messages have been acknowledged but errors are still pending, these messages will then be shown again.

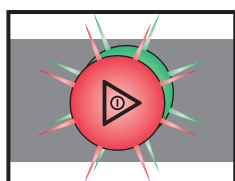

Information

- Limited operation is possible.
- The ON/OFF button ① illuminates green/red alternately.
- The error code is shown in the display (see table).

Error code	Message text	Measure
003	Temperature not reached. Contact service technician.	Contact your HOBART Service Partner.
004	Temperature not reached. Contact service technician.	Contact your HOBART Service Partner.
008	Temperature not reached. Contact service technician.	Contact your HOBART Service Partner.
009	Temperature not reached. Contact service technician.	Contact your HOBART Service Partner.
021	Fault in the drain system. Clean the drain hose if necessary and pump-out the machine again.	Clean the drain hose if necessary and pump-out the machine again.
022	Fault in the drain system. Clean the drain hose if necessary.	Clean the drain hose if necessary.
029	Program aborted. Close Hood.	Close hood.
036	Detergent deficiency. Refill detergent.	Refill detergent (see section 6.9).
037	Rinse aid deficiency. Refill rinse aid.	Refill rinse aid (see section 6.9).
038	Input voltage too high! Machine has been switched off.	Have the input voltage checked by the (site) electrician.
039	Filling program aborted. Close Hood.	Close hood.
041	External water treatment depleted. Replace.	Replace part or full desalination cartridge.
042	Osmosis pre-filter depleted. Replace.	Replace pre-filter.
043	Salt deficiency. Refill regenerating salt.	Refill regenerating salt (see section 6.8).

Fault indications and problems

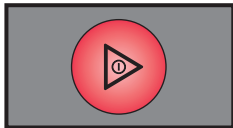
**Faults**

- Limited operation is not possible.
- The ON/OFF button ① illuminates permanently red.
- The error code is shown in the display (see table).
- Once the error display has been acknowledged, the machine switches off.

Error code	Message text	Measure
001	Hot water tank temperature sensor fault. Contact service technician.	Contact your HOBART Service Partner.
002	Hot water tank temperature sensor fault. Contact service technician.	Contact your HOBART Service Partner.
006	Wash tank temperature sensor fault. Contact service technician.	Contact your HOBART Service Partner.
007	Wash tank temperature sensor fault. Contact service technician.	Contact your HOBART Service Partner.
011	Wash chamber temperature sensor fault. Contact service technician.	Contact your HOBART Service Partner.
012	Wash chamber temperature sensor fault. Contact service technician.	Contact your HOBART Service Partner.
013	Disinfection not guaranteed. Contact service technician.	Contact your HOBART Service Partner.
014	Booster pressure sensor fault. Contact service technician.	Contact your HOBART Service Partner.
015	Booster pressure sensor fault. Contact service technician.	Contact your HOBART Service Partner.
016	Wash tank pressure sensor fault. Contact service technician.	Contact your HOBART Service Partner.
017	Tank pressure sensor fault. Contact service technician.	Contact your HOBART Service Partner.
018	Fault in the filling or drain system. Contact service technician.	Contact your HOBART Service Partner.
019	Strainer blocked. Remove, clean and re-insert.	Remove, clean and re-insert strainer.
020	Wash tank pressure sensor fault. Pump-out machine.	Pump-out machine.
023	Fault in the filling system. Supply quantity too low.	Check site flow pressure.
031	Fault in the filling system. Check water supply.	Check water supply.
032	Fault in the filling system. Check water supply.	Check water supply.
033	Fault in the filling system. Contact service technician.	Contact your HOBART Service Partner.
035	Insert tank cover strainer correctly.	Insert tank cover strainer correctly.
044	Salt deficiency. Refill regenerating salt.	Refill regenerating salt (see section 6.8).
045	Number of wash cycles without regenerating salt exceeded. Contact service technician.	Contact your HOBART Service Partner.
052	Fault in the filling or drain system. Contact service technician. Disconnect machine from the water and power supply!	Contact your HOBART Service Partner.

Fault indications and problems

9.2 Remediating the problem

9.2.1 Poor wash result

Nature of the problem	Possible cause	Remedy
Washware not clean.	Wash arms stiff (you should be able to turn them easily by hand).	Remove wash arms and clean them thoroughly. Also check water outlet from machine to wash arms is clear.
	Wash arm nozzles are clogged (visual check).	Remove wash arms, remove cleaning caps and rinse wash arms thoroughly until all soiling is removed. Replace cleaning caps.
	Rinse nozzles clogged (usually by lime deposit).	Remove rinse arms and decalcify them in separate container. Check site softener system for function.
	Regeneration concentration is too low or too high.	Check detergent concentration setting.
	Coarse strainer clogged.	Remove, empty and clean strainer.
	Fine strainer clogged or obstructed by lime deposits.	Remove fine strainer. If heavily soiled, soak in a vinegar solution. Then clean it thoroughly with a brush until the pores are free. The fine strainer should generally be cleaned daily (see operating instructions).
	Wrong program selected for heavily soiled washware.	Select program with longer wash cycle.
Washware does not dry properly.	Rinse aid dosing too low.	Increase concentration (see operating instructions).
	Washware still greasy.	Detergent concentration too low: increase (see operation instructions). Check if detergent is appropriate. If not, choose a stronger one. Drain contaminated water and refill machine. Clear washware more thoroughly beforehand.
	Rack is not suitable for type of dishes (sloping).	Use appropriate racks to create a sloping position which allows water to drain away from cavities.
	Washware remains in the machine too long at the end of rinse cycle.	Remove washware as soon as cycle is completed to enable it to dry.

Fault indications and problems

Nature of the problem	Possible cause	Remedy
Streaks and spots on washware.	Rinse aid concentration too high (stripe or bubble formation).	Reduce concentration (see operating instructions).
	Hard water or high mineral content.	Check water quality. Every local water works holds data on the composition of the water they supply and will provide these on request. Reference values: Ideal calcium value: 0 – 3 °d (total hardness). Ideal mineral content value: for glasses, max. conductivity 100 µS/cm, for dishes, still viable to max. 400 µS/cm.
	Rack is not suitable for type of dishes (sloping).	Use appropriate racks to create a sloping position which allows water to drain away from cavities.
	Inadequate rinse aid dosing causes stains.	Increase rinse aid concentration (see operating instructions).
	Machines with integrated softener: use of wrong salt (e.g. tablets).	Do not use salt tablets.

9.2.2 Other problems

Nature of the problem	Potential causes	Remedy
Glasses are totally or partially cloudy.	Surface of glasses is rough and porous, this is called glass corrosion.	Use new glasses, this is not caused by a malfunction on the machine.
Glass/dish breakage.	Use of unsuitable dish or glass racks.	Use suitable racks.
Machine switches off suddenly during operation.	Machine coupled to a maximum system or locked against other current consumers.	Have machine connected separately (electrician!).
	A site fuse has tripped.	Check site fuses.

Maintenance

10 Maintenance



In order to maintain the warranty, as well as a permanently safe, efficient, and trouble-free operation of the machine(s), the required maintenance must be carried out by authorized service technicians.

We therefore recommend the conclusion of an inspection and maintenance contract, which guarantees qualified support by specially trained service technicians according to a time schedule based on the operating conditions.

In Germany, your HOBART machines are governed by the Ordinance on Industrial Health and Safety and must be inspected by a qualified electrician in accordance with the intervals specified in BGV A3.

11 Disposal



The machine operator is responsible for disposing of the machine and its operating materials correctly and in accordance with environmental regulations. Observe the national and local legal provisions and regulations.

HOBART GmbH

Robert-Bosch-Str. 17
77656 Offenburg
Deutschland
Tel.: +49 (0)781.600-0
Fax: +49 (0)781.600-23 19
E-Mail: info@hobart.de
Internet: www.hobart.de

Hobart UK.

Southgate Way,
Orton Southgate,
Peterborough
PE2 6GN
United Kingdom
Tel.: +44 (0)844 888 7777
Republic of Ireland: +353 (0)1246 0248
Fax: +44 (0)1733 361 347
E-mail: sales@hobartuk.com
Internet: www.hobartuk.com

Compagnie HOBART SAS

Allée du 1er mai
77183 Croissy Beaubourg
FRANCE
Tel: +33 (0)1 64 11 60 00
Fax: +33 (0)1 64 11 60 10
E-mail: contact@hobart.fr
Internet: www.hobart.fr

Hobart Nederland BV

Pompmlenlaan 12
3447 GK Woerden
Telefoon +31 (0)348 462626
Fax: +31 (0)348 430117
E-mail: info@hobartnederland.nl
Internet: www.hobartnederland.nl

Hobart Foster Belgium bvba/sprl

Industriestraat 6
1910 Kampenhout
Telefoon +32 (0) 16.60.60.40
Fax +32 (0) 16.60.59.88
E-mail: info@hobart.be
Internet: www.hobart.be

Hobart Norge

Gamle Drammenvei 120
N-1363 Høvik
Tlf.: +47-67109800
E-post: post@hobart.no
Hjemmeside: www.hobart.no

Hobart Scandinavia ApS

Håndværkerbyen 27
2670 Greve
Danmark
Tlf.: +45 4390 5012
Fax.: +45 4390 5002
E-mail: salg@hobart.dk
Internet: www.hobart.dk

Hobart Sweden/Finland

Tel: +46 8 584 50 920
E-mail: info@hobart.se
Internet: www.hobart.se

Australia**Hobart Food Equipment**

Unit 1 / 2 Picken Street,
Silverwater NSW, 2128
Tel: +61 1800 462 278
Fax: +61 02 9714 0222
E-mail: sales@hobartfood.com.au
Internet: www.hobartequipment.com.au

HOBART China

15th Floor, Building A
New Caohejing International Business
Center
391 Gui Ping Road
Shanghai, 200233
Telephone: +86 (0)21 34612000
Fax: +86 (0)21 34617166
Internet: www.hobartchina.com